

# ACORN • USER

BBC MICRO • ELECTRON • ATOM

JULY 1984 £1

**In depth:**  
how Plus 1 aids  
Electron upgrade

**New users:**  
First Byte helps  
you get started

**At last:**  
a first-class  
database ROM

**Programs:**  
16 pages of  
fun and learning

**Business:**  
Z80 software  
under the microscope

**Schools:**  
setting up a  
viewdata system

**Looking to  
the Future  
of Communications**

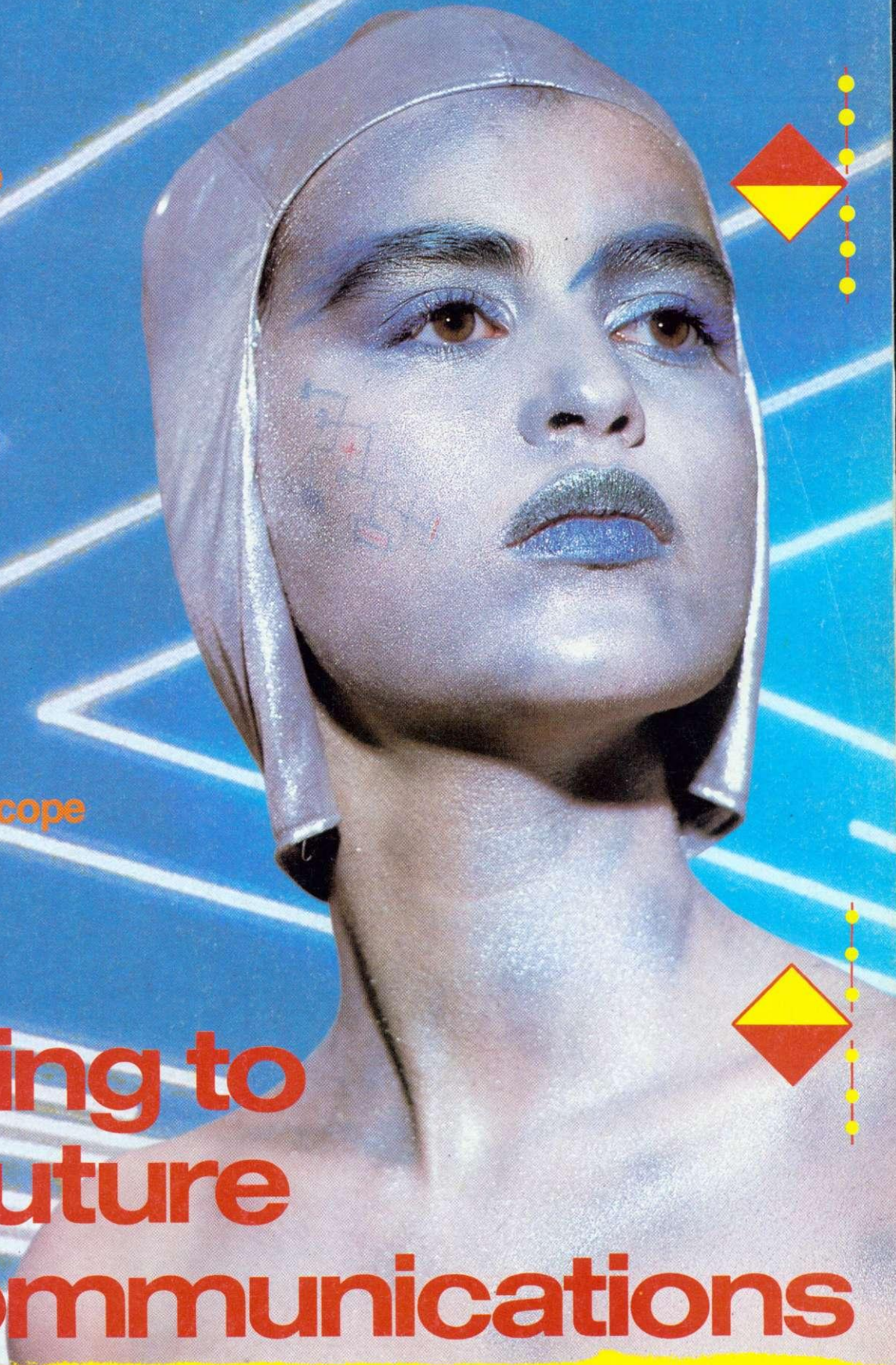

# COMPLETE CONTROL AT YOUR FINGERTIPS....



AVAILABLE FROM ALL LVL DEALERS. (FOR FURTHER INFORMATION TELEPHONE 0602 394000)

**B**ritish made and fully guaranteed, the LVL twin joysticks are professional units with which your aim should be nothing less than total control.

They will operate any programmes that have a joystick option and are written in a way that is compatible with ACORNSOFT.

- Nylon encased - Steel shafted joysticks with ball and socket joint
- Fast spring return to centre
- Graphite wiper linear potentiometers
- 12 months guarantee
- Fully compatible with the BBC model 'B' or 'A' fitted with an A/D interface and an analogue part.



Scientific House,  
Bridge Street, Sandiacre  
Nottingham, NG10 5BA  
Telephone (0602) 394000



# THREE NEW PROGRAMS FROM MICROTEST

## DAIRYFILE FOR DAIRY FARMERS

Keep on that economic line between over and under feeding!

Save time recording milk yield and calculating feed amounts!

Quickly decide feeding policy with the 'Monthly Calving Group' Performance Graph!

Print out a recording sheet with cows in numerical order. Print out graphs or tables of individual cows or Monthly Groups showing serving and pregnancy details, illness record, Calving Index, weekly and running total Margin over Concentrate. See at a glance cows due for serving, pregnancy diagnosis and drying off. Keep track of weekly total feed cost and milk sale price.

All this and more with DAIRYFILE.

Predict cow or Monthly Group total lactation yield. Compare with Standard Lactation Curves. All old data preserved - compare Monthly Groups over the years. Which is the most profitable month?

Find out with DAIRYFILE - for up to 200 lactating cows.

**£69.00 inc. VAT (disc only).**

2 x 40 Track Drives Required or 1 or more 80 Track Drives. Please state which when ordering.

## SATAN'S CHALLENGE or (Nevil Rides Out)

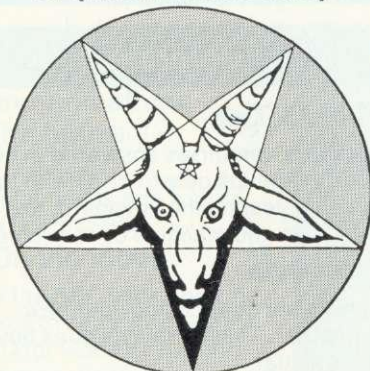

### A Black Magic Adventure

Dare you take up the challenge laid down by the most evil and sinister of all beings... the devil himself. If you do you will find yourself alone and at the mercy of the twisted fancies and whims of a cold and calculating mind.

Occult forces are threatening the lives of those near and dear to you. Their only salvation rests in your hands but in accepting the challenge your own existence is put in severe peril.

In taking up the challenge you have to find The TALISMAN and locate a pentagram which then has to be prepared for the final rite. In the meantime dark forces will be opposing you making a difficult task almost impossible.

Do not allow yourself to be lulled into a sense of security for it will be short lived.

Many have gone before only to swell the ranks of the damned.

This is the latest adventure from the stables of Microtest and has been written with the acclaimed features of other adventures in mind eg save facility, quick response, simple but extensive commands, a mixture of logical and friendly problems to solve.

**Be warned this is an easy adventure to get into but devilishly difficult to end.**

"Destined to become a classic in its own right." CN  
Cassette £7.95 inc. VAT Disc 9.45 inc. VAT  
Disc 40 or 80 Track.

## MICROTEST FONT ROM.

This exciting new ROM from Microtest will enable you to get all sorts of new characters and fonts from your BBC Computer. Once you have produced your masterpiece on the screen, all you have to do is use the inbuilt screen-dump utility to produce a hard copy on to paper.

Typing '\*HELP FONTS' gives a list of available fonts and the blocks of characters which they replace.

Available fonts are:

- \*Accents Accents and miscellaneous.
- \*Block Small capitals.
- \*Data Like the bottoms of cheques.
- \*Greek It's all Greek to me too!
- \*Joined Standard capitals with joined up lower case.
- \*Maths A mix of until now unobtainable Mathematical symbols.
- \*Miscellaneous A few oddities which often are very necessary.
- \*Thick Thick text (for MODEs 0&3) to enhance 80 column mode.
- \*Thin Thin text (for MODEs 2&5) which makes modes 2 & 5 much more readable or perhaps "READABLE".
- \*Vertical For labelling graphs.

The ROM has a dump facility which will produce a screen dump of any MODE for 0 to 6 on an Epson, Star printer, CTI CP80 or MT80.

The ROM uses absolutely NO user memory and can be used with word processors etc. as well as normal BASIC programs.

**£17.50 inc. VAT**

## Microtest Starstick ROM & Joystick Package

Now available the Starstick ROM and Joystick. This comes in three forms:



- (A) The Starstick ROM and Quickshot I Joystick  
Price 17.95 + VAT = 19.84
- (B) The Starstick ROM and Quickshot II Joystick  
Price 19.25 + VAT = 22.14
- (C) The Starstick ROM and patch lead, choose your own Spectrum/Atari style joystick  
Price 15.25 + VAT = 17.54

Post and Packing £1.00 inc. VAT per item

This enables you to plug the Rapid action self centring joysticks until now only available for the Spectrum/Atari/CBM machines into the user port of the BBC. Model A users please note NO ANALOGUE INTERFACE REQUIRED.

Disc Users Note - pressing BREAK, SHIFT-BREAK or CONTROL BREAK does not modify or destroy the STARSTICK software so Disc Users please feel free to Boot!

The software patch provided in the ROM is interrupt driven and adds the following commands to your computer.

- \* STICK turn on the STARSTICK ROM
- \* NSTICK turn off the STARSTICK ROM
- \* SETSTICK set up joystick to users spec
- \* SAVE "NAME" 140 160 saves your user-key protocols
- \* ADVAL emulate standard analogue joysticks
- \* PAUSE define key to Freeze game
- \* NPAUSE turn off ability to freeze game
- \* "NAME" predefined key protocols set up for software houses programs
- \* HELP KEYS displays currently selected key protocols
- \* REPEAT enables auto-repeat fire
- \* NREPEAT disables auto-repeat fire

Enables you to use our joysticks even on programs that do not offer joystick capability.



DEALER ENQUIRIES  
and  
EXPORT ORDERS  
WELCOME

available from

**MICROTEST LTD**

**18 Normandy Way, Bodmin, Cornwall PL31 1EX**

**Telephone: 0208 3812**

OR ANY GOOD DEALER

Large picture shows BBC Computer System and a Quickshot II Joystick. Small inset just a few of the joysticks that will work with the patch lead. Screenshots by kind permission of SUPERIOR SOFTWARE

VISA



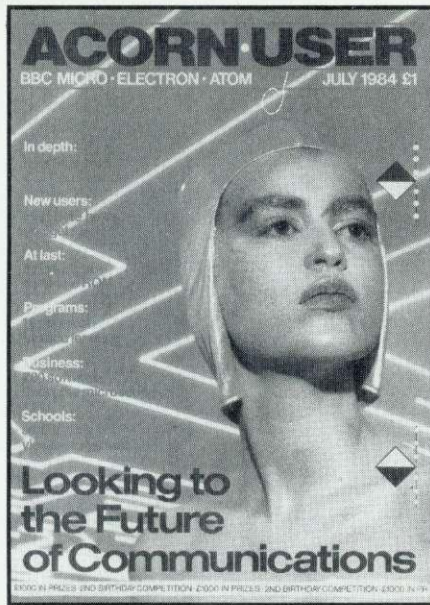

2

July 1984 No 24  
Cover photography by Monica Curtin; hat by Stephen Jones; make-up by Jalle Bakke

Editor **Tony Quinn**  
Production editor **Keith Parish**  
Technical editors  
**Alex van Someren, Bruce Smith**  
Editorial assistant **Kitty Milne**  
Art editor **Nigel Wingrove**  
Art assistant **Frances King**  
Publishing director **Michael Potter**  
Editorial director **Christopher Ward**

**Editorial**  
Redwood Publishing,  
68 Long Acre, London  
WC2E 9JH. Tel: 01-836 2441

**Advertising**  
Computer Marketplace Ltd, 20  
Orange St, London WC2H 7ED.  
Tel: 01-930 1612

**Subscriptions**  
Jan Potter, Subscriptions manager.  
Tel: Nutfield Ridge (073782) 2957.  
Correspondence: Redwood Pub-  
lishing, 68 Long Acre, London  
WC2E 9JH.

**Annual subscription rates:**  
UK £15  
Europe £18  
Middle East £20  
The Americas and Africa £22  
Rest of the World £24  
*Prices include p&p for 12 issues*

Typeset and printed in Great Britain by Wat-  
moughs Ltd, Bradford. Print production by  
Aquarius Print and Design, London. Distri-  
buted to the news trade by Comag, Tavistock  
Rd, West Drayton, Middlesex UB7 7QE. Tel:  
(0895) 44405.

© Redwood Publishing 1984  
All rights reserved. No part of this publi-  
cation may be reproduced without prior  
written permission of the publisher. The  
publisher cannot accept any responsi-  
bility for claims or errors in articles, pro-  
grams or advertisements published. The  
opinions expressed on the pages of this  
magazine are those of the authors and  
do not necessarily represent those of the  
publisher, Acorn Computers Ltd, or  
Acornsoft Ltd. Acorn, Acornsoft, and the  
Acorn symbol are the registered trade-  
marks of Acorn Computers Ltd and  
Acornsoft Ltd.

## Beginners

### Hints & Tips **51**

Readers' enquiries answered in detail. Martin Phillips gets to grips with tape loading, testing the keyboard, text windows and machine code problems

### First Byte **60**

How to set about using your new computer. Tessie Revivis goes beyond the manual.

**PLUS:** Converting listings. Tessie explains the differences between BBC and Electron, and shows how to cope with them

### Letters **65**

Your views, gripes and comments in print on statistics, error codes and the Data Protection Bill

### Dear Kitty . . . **69**

The computer world's first true Agony Auntie answers the sort of questions which might seem simple to some, but confuse many

## Business

### Z80 low-down **99**

The software bundle that comes with Acorn's second processor promises much. John Vaux finds out whether it lives up to the hype

### Database ROM **103**

StarBase from GCC controls searching and sorting of information held on disc. Ian Rowlings reports

## Education

### Viewdata in action **108**

Tecmedia's Edfax sets up colour viewdata pages. Geoff Nairn reports on its use

### Teaching facts **111**

Several software projects are on the way to help teach children about information and how to use it. Jean Beck presents a round-up

## Atom

### Converting Basics **121**

Barry Pickles presents the concluding part of his explanation of BBC and Atom Basic and how to convert a program from one to the other

### Atom Forum **123**

Barry Pickles presents a lively Atomic mix

## Reviews

### Electron Plus-1 **18**

Acorn's add-on box means printers and joysticks can be connected, and ROM cartridges used. Bruce Smith tries it out

### Solidisk 128k RAM **153**

A memory board with the capabilities of a disc drive. Malcolm Banthorpe sets out its special capabilities

### IEEE trio **155**

Paul Beverley compares three versions of the IEEE interface for the BBC micro from Aries, Acorn and CST-Procyon

### Printers **161**

George Hill on Canon's colour ink-jet printer, plus Barry Pickles on the Brother EP44

### Utilities **137**

The ADE ROM gets a thorough going-over by Vincent Fojut

## Yellow listing pages

An extra 16 page section devoted solely to the major listings in this issue

- Program of the month** **i**  
*Print your own function key strips with Andrew Britton*
- Hints and Tips** **ii**
- Joe's Jottings** **iii**
- Inspect utility** **vi**  
*Martin Clayden helps you examine a Basic program held on disc*
- Beeb Forum** **vii**
- How it works** **ix**
- IEEE interface programs** **xi**
- Utilities for printers** **xiii**
- Sound effects** **xvi**  
*Five readers earn some cash for their astounding noises*

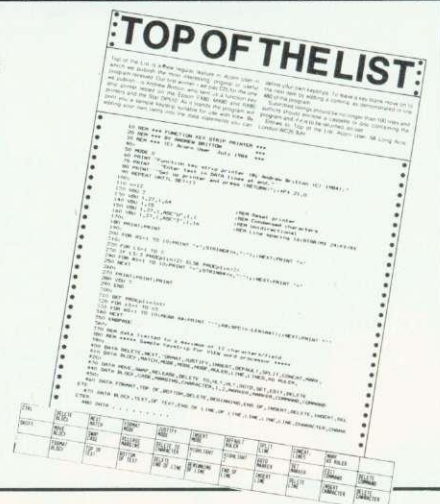

## Books 141

Five books opened up by Vincent Fojut, Barry Pickles and Jeremy Bennett

## Games & adventures 147

Alligata's *Bridge*, Level 9's *Lords of Time*, Program Power's *Jet-Power Jack*, *Daredevil Denis* and *Demolator* from Visions, and *3D Tank* from Dynabyte

## Regulars

### The News 7

16032 developments, Torch progress, BBC games for Electron, Communications '84, chip camera, Acorn User Exhibition, educational software and CP/M programs

### Joe's Jottings 32

The nitty gritty of communications is Joe Telford's subject

### Beeb Forum 75

Experts unite to bring you the best in techniques and ideas for the Electron and BBC. Bruce Smith is at the helm this month on the subject of BBC Basic

### How it works II 81

Slow your micro down to see exactly how it works. Paul Beverley keeps the machine so busy it can barely cope

### Competition 94

Software worth £1,000 on offer this month

### Top 20 software 145

What's up, down and around, plus Soft Options, giving a round-up of the program scene

### Readers' free ads 181

### Small ads 183

### Acorn Abuser's Diary 184

Last, but not least, the wicked, sensational, and downright naughty goings-on in the world

## FRAYED FINGERS? FRAYED TEMPER?

Save yourself the bother with the Acorn User cassette of all the listings in this issue! See page 177 for order form.

# IN THIS ISSUE...

## Communications I The future 27

An overview of developments and where they could lead

## II On the move 28

How the BBC uses portable micros to send stories back to HQ for wordprocessing

## III The nitty gritty 32

Joe Telford's Jottings explain the theory and practice of modems and electronic mail



## Second birthday competition 94

Yes, Acorn User has been going for two years! Simon Dally presents an easier than usual quiz with 100 games and sweatshirts as prizes

## Edfax 108

Set up your own viewdata system and generate pictures to be saved on disc with this utility from Tecmedia. Geoff Nairn lets you know what he thinks of it



## NEXT MONTH...

### Downloading the weather

Satellite pictures of Europe on a BBC micro! Robin Mudge reports on how it's done

### Keeping the kids busy

Joe Telford presents his ideas on occupying the little ones during the summer

### Hints, tips and first bytes

Correcting listings, adding a second disc drive, Wordwise aids, coloured listings, using the keyboards... all this and much more

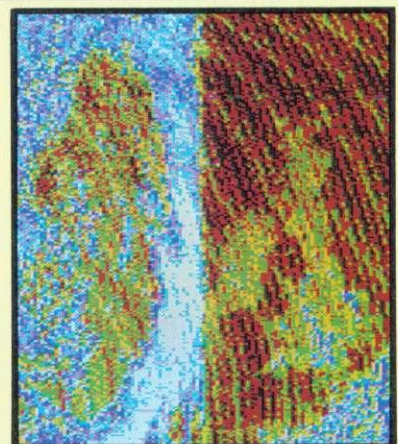

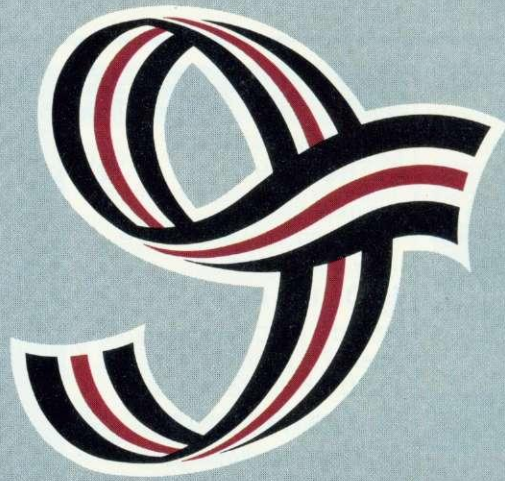

**The Graduate.**

**The first IBM P.C.  
compatible upgrade  
for the BBC model B micro.**

# For an amazing mail order price of £599 (ex. VAT) the Graduate will upgrade the BBC Model B to a powerful 16-bit business computer

Fully disk and hardware compatible with the IBM P.C., the Graduate's MS<sup>TM</sup>-DOS operating system allows exploration of the massive range of IBM compatible business software, programming aids, compilers and languages universally available from all major software houses.

With a simple command stroke, the system can revert to Acorn's own operating system, thereby allowing programmes in BBC Basic to be stored on disk, using the Graduate's own disk controller.

## Introduction to MS<sup>TM</sup>-DOS

The Graduate offers two levels of upgrade, the G400 and the G800, both with 128K user memory as standard. This can be expanded up to 256K on board, or to 1.2 Mbytes with an IBM compatible expansion board. The G400, which is available only through mail order, contains a single, double sided 400K BASF

### TECHNICAL SPECIFICATION

- 8088 16-bit processor running at 5 Mhz
- 128K RAM (Expandable to 256K)
- MS<sup>TM</sup>-DOS operating system customised to IBM compatibility
- Model G400 – Single, double sided, high density BASF disk drives (400K unformatted)
- Model G800 – Twin, double sided, high density BASF disk drives (800K unformatted)
- Integral stabilised power supply
- 2 IBM P.C. compatible hardware expansion buses
- Colour Software provided (not G400)
- Perfect 2 Writer/Speller (Word Processing)
- Perfect 2 Calc (Spread-Sheet)
- Perfect 2 Filer (Database)
- Disc interface is not required
- Keyboard text and graphics supplied by BBC Model B

disk drive and provides the perfect introduction to MS<sup>TM</sup>-DOS for the user who wants real power from his Model B.

## Strong combination of Hardware and Software

A step up from the G400 is the G800 which offers twin, double sided 400K disk drives for extra data storage, together with the Perfect 2 Software suite

of business programmes (colour version) comprising Word Processing, Spread-Sheet and Database. This strong combination of hardware and software upgrades your BBC Model B to a versatile business management aid, with the option of even further upgrading for networking, modems, etc., via the IBM compatible hardware slots provided by the Graduate models. Both models come complete with a well written user/technical manual, connecting leads and a mail order catalogue featuring ancillaries and peripherals.

## Just plug it in

The compact and tidy Graduate models simply plug in to the 1MgHz bus on the Model B. Within minutes you can be up and running with a fully IBM compatible system that really means business.

To be first with the Graduate, or for further information complete the coupon **today**.

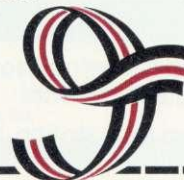

 **The Graduate.**  
In a class of its own

To: Data Technologies Ltd., Century House, Market Street, Swavesey, Cambridge CB4 5QG. Tel: (0954) 30817

**Order.** Please send me

Qty \_\_\_\_\_ Graduate G400(s) @ £688.85 (inc. VAT)

Total £ \_\_\_\_\_

Qty \_\_\_\_\_ Graduate G800(s) @ £999.35 (inc. VAT)

Total £ \_\_\_\_\_

Cheque enclosed to the value £ \_\_\_\_\_

**Information.** Please send me free colour literature, the name of my nearest appointed dealer (G800 only) and order forms.

Name \_\_\_\_\_

Address \_\_\_\_\_  
\_\_\_\_\_

Telephone \_\_\_\_\_

Occupation \_\_\_\_\_

Allow 28 days for despatch of goods. Full 14 day money back guarantee. Full 12 month parts and labour warranty.

# THIS IS THE BIG ONE!

## The 2nd Official Acorn User Exhibition

**OLYMPIA AUGUST 1984**

Thursday 16th – 10am to 7pm  
Friday 17th – 10am to 6pm  
Saturday 18th – 10am to 6pm  
Sunday 19th – 10am to 5pm

\* Please note 10am to 2pm on Thursday 16th  
is Trade Morning – By invitation only.

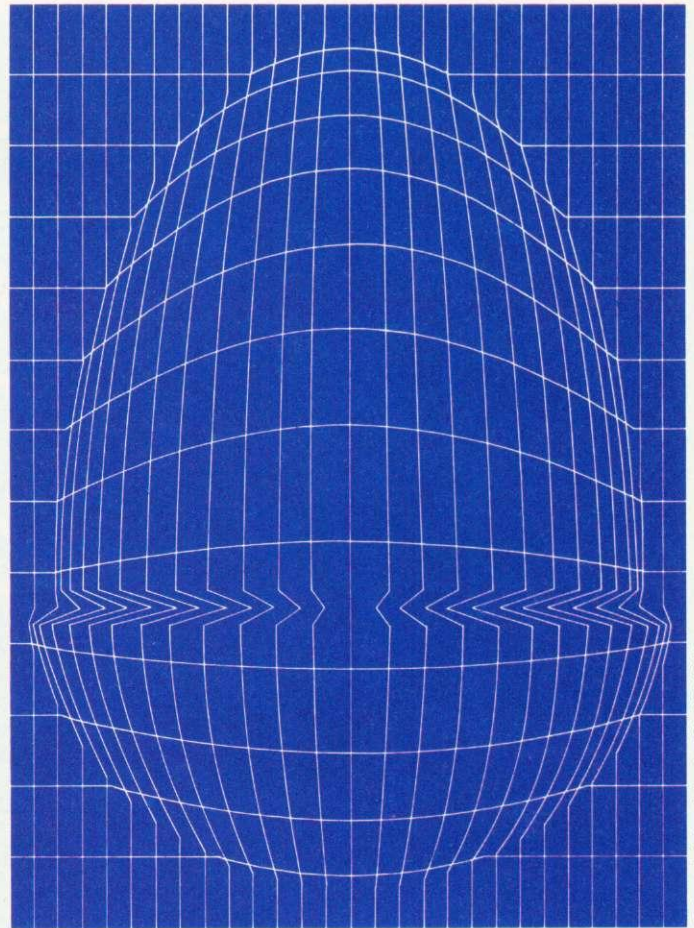

© Certain Advertising Ltd 01-930 1612

### BIG VALUE

The success story of Acorn Computers, the BBC Micro and Electron is mirrored by suppliers who have produced more and more hardware, software, supplies and services. And they'll all be at the exhibition – disk drives, plotters, printers, monitors, joysticks, robots, books and magazines, all kinds of software – everything for the Acorn owner.

And of course Acorn will be there in force with all their latest developments and software.

There'll be special offers, competitions, advice centres and special events as well.

And all this for only £3.00 at the door, under sixteens £2.00. (Use the coupon to beat the queues and save £1.00).

### BIG VENUE

Olympia 2 is the brand new exhibition centre next to the old Olympia. It's got everything, wide gangways, lots of space to sit down and rest, plenty of catering areas.

Getting there is easy too, its got its own tube station, bus routes 9, 27, 28, 33, 49, 73 and 91 go right pass the door, and there's car parking too!

### BIG SUPPORT

Remember this is the *Official Acorn User Show*, it's the most informative prestigious and influential user show in the country. Whether you're a businessman, serious user or games enthusiast there's something for you.

For details of exhibition stands and advance ticket sales contact the organisers.

Computer Marketplace (Exhibitions) Ltd. A Rushworth Dales Group Company, 20 Orange Street, London.  
WC2H 7ED Tel: 01-930 1612

### BEAT THE QUEUES! SAVE MONEY! ORDER YOUR TICKET IN ADVANCE.

Buy your ticket now and save queuing. There will be special entrances for advance ticket holders.

Please send me \_\_\_\_\_ (qty) tickets at £2.00 and \_\_\_\_\_ (qty) under sixteen tickets at £1.00. I enclose my cheque/PO  
to the value of £\_\_\_\_\_ or debit my Access card. No. \_\_\_\_\_

NAME \_\_\_\_\_ SIGNED \_\_\_\_\_

ADDRESS \_\_\_\_\_

\_\_\_\_\_ POSTCODE \_\_\_\_\_

**GROUPS** – Order 15 or more tickets and you qualify for a further 20% discount.

To: Computer Marketplace (Exhibitions) Ltd. A Rushworth Dales Company, 20 Orange Street, London WC2H 7ED.



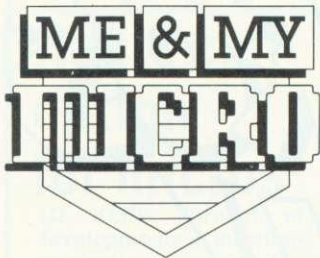

THE ITV computer series *Me & My Micro*, which aims to teach Basic programming on a Sunday morning, has made copies of the listings featured in the series available to viewers.

The programmes feature the Electron, and so all the software should run on the BBC micro. Comments on the routines are included, and 'souped-up' versions of the games.

To receive the support material, send an sae to: *Me & My Micro*, Admail 1, Leeds LS3 1YS.

## Medical package is fit for Beeb

A BBC micro-based system has been developed for GPs by Abies Infomatics.

The Abies package uses a 6809 second processor with 64k RAM to store patients' records and is supplied complete with software.

Abies software has been available for mainframe computers for several years, and with the help of Cambridge Microcomputer Systems Abies has adapted the software to run on the Beeb.

Further details: 01-994 6477.

## BBCSoft's Electron push

BBCSoft will produce Electron versions of its games starting in the autumn – and make software spin-offs from educational TV and radio programmes available to the trade.

Software manager David Atherton explained: 'We are going to do versions for the Electron, starting with *White Knight 11* in the autumn.'

'From then on, everything will go to the Electron, apart from disc-only programs, or those which just won't run.'

'*Waves* will be the first in a series of 10 packages from *Science Topics*, all going to the trade.'

Four releases set for September are: *Gamescore*,

# Acorn dispels superchip doubt

THE 16032 second processor from Acorn looks unlikely to appear before the end of the year, but the project is definitely going ahead.

Rumours in Cambridge earlier this year suggested that Acorn might drop the 32-bit 'superchip' which is the final part of the BBC system.

Speculation was enhanced by stories in the computer Press that National Semiconductor, which makes the chips, was having trouble getting them to run at 10MHz, the speed Acorn was reported to want.

However, a high-ranking source within Acorn has denied the rumours and said: 'We are definitely in a go state on this product.' He would not elaborate, or give any details on the timing, price or specification of the system.

Prototypes have been housed in the standard second processor box with  $\frac{1}{4}$ Mbyte of memory provided by 64k RAMs. This is the minimum memory required to run the operating system Unix (or Xenix, as the micro version is called), but the memory size could be increased by using

the latest 256k memory chips.

A spokesman for National said the 16032 chips were available running at 8MHz, but that it would take time to get them up to 10MHz. 'We have customers doing things with 8MHz chips. It depends what Acorn wants to do.'

It has taken about five months to increase the chip speed from 6 to 8MHz, but the company could not give a precise date for the 10MHz version. 'It could be two, three or five months. It could be earlier, it could be later.'

The 16032 actually consists of five chips, two of which are giving the problems.

Once Acorn has decided to accept the chip set, Logica is confident there will be no delay in implementing Xenix.

● As this issue went to press it was announced that the 16032 has been rechristened as the 32016 by National.

## TV fame for school winners

A SPECIAL one-hour micro show will go out live from BBC TV on Sunday June 24 to announce the results of the BBC's schools competition – and it will herald the start of a new magazine programme.

The live show follows the success of the first *Micro Live Special*, which brought in an audience of a million people

on a Sunday morning. All 15 regional winners of the competition will be in the studio, with the final results made in the traditional 3,2,1 style.

The new magazine series will be monthly and will start in October. Some of it will be recorded, and some will go out live, depending on studio demand.

## Meet authors at the Acorn User Show

ACORN USER authors will be holding a special clinic to help readers with their problems at this year's Acorn User Exhibition in August.

Other special attractions will be displays on education and robotics, with the MEP (Microelectronics Education Programme) showing a touch-screen add-on for the BBC micro.

This year's Exhibition will be held in Olympia. It opens with a trade-only day on August 16, through till Sunday August 19.

Several companies will be exhibiting in what Tim Collins, the organiser, has tentatively named 'Robot Road', showing what to interface to your micro.

Information from Tim Collins at Computer Market-place, 20 Orange Street, London WC2H 7ED.



Fred Harris on BBC and ITV

which provides routines for building your own strategy board games; *Drawstick*, a graphics painting program; *Wordmover*, a simple text editor aimed at education; and *Astronomy*, a set of graphics demonstrations on the moon, eclipses and planetary motion,

and a moon lander-type game.

The fifth is *Using Your Computer* – a spin-off from schools radio broadcasting. It is aimed to give children aged 8–11 an introduction to micros. At £29.95 it sounds expensive, but includes a book, audio tapes and 12 programs on cassette. Fred Harris, currently fronting Yorkshire TV's *Me and My Micro* series, did the voice recordings and put the package together.

Nearer Christmas, the packs from the *Science Topics* TV series will appear. First will be *Waves*, featuring physics experiments based on ripple tanks, followed by other software, which will be available only on disc.

# 25 BBC MICROS TO BE WON!



## WALL'S ICE CREAM AND ACORN COMPUTER INVITE SCHOOLS TO DEVISE A COMPUTER GAME

Here's a great chance to win one of 25 BBC Microcomputers (B) for your school.

To celebrate the launch of the new MegaBytes lolly, Wall's and Acorn are offering these superb micros free to winners of this 'Mega' competition.

The competition is open to all UK primary, secondary and special schools.

To enter, each school team must:

1. Devise a computer game program which features ice lollies and;
2. List as many words as possible using letters from the phrase: 'Wall's and Acorn!'

There is no limit to the number of

entries per school but each entry must be accompanied by fifteen MegaBytes lolly wrappers and arrive by 28 July 1984 at MegaBytes, PO Box 4XZ, LONDON W1A 4XZ.

Entries will be judged by a young computer games author and a team of professional programmers from Acornsoft. Points will be awarded for originality; quality of graphics; speed; sound effects; playability and overall presentation with attention to detail.

To win a computer, your school entry must have a high scoring game program and a sufficient number of words.

### FULL RULES

1. Entries can be submitted on cassette or disk and written in either BBC Basic or machine code, each entry being signed by the teacher of computer studies or head teacher of the school. Entries should run on a BBC Microcomputer Model B or Acorn Electron.
2. All games must be clearly identified and accompanied by a full printed listing as well as a games catalogue style description of the game (not more than 200 words). The cassette/disk and listing should each carry the entrant's name and address.
3. Each school may only win one prize, irrespective of the number of entries of games submitted. Entries will be acknowledged upon receipt but not returned. Correspondence will be entered into at the absolute discretion of the promoters.
4. The entry instructions constitute part of the competition rules and are binding upon entry.
5. Responsibility cannot be accepted for entries lost, damaged or delayed in transit to the competition address. Illegible or altered entries will be disqualified, as will those not conforming to the entry instructions.
6. Entries will be judged by a panel of judges which will contain at least one independent member not connected with the promoter. The decision of the judges will be final and legally binding and in all respects of the competition the decision of Birds Eye Wall's Limited shall be final.
7. Copyright in all material entered rests in Paragon Communications on behalf of Birds Eye Wall's Ltd., and Acornsoft Ltd.
8. Winning schools will be notified as soon as possible after the closing date. A list of winners will be sent to anyone who encloses a stamped addressed envelope with their competition entry.
9. Entry is open to all qualifying UK residents except for employees of Birds Eye Wall's and Acorn Computer, their advertising and promotion agencies, or anyone directly connected with the competition or their families.

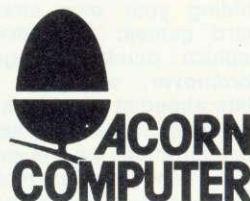
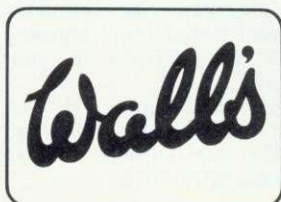

## Radio cell option for micros

TO KEEP abreast of developments in the communications world the Editor and I made our way to the National Exhibition Centre in Birmingham where the electronics industry had gathered for Communications '84.

Several manufacturers were previewing their cellular radio systems which allow telephone subscribers to move about the country and have calls routed to them automatically.

This is accomplished

### Communications



by dividing the country into a number of hexagonal cells, each of which contains a radio transmitter/receiver.

Racal, one of the leaders in this area, was also displaying the new Epson PX8 portable computer which brief interrogation revealed as a statement of their intention to upgrade the cellular system to allow computer data transmission.

British Telecom had the Healthnet terminal on show. This is an Electron with a custom-made expansion box, and it is intended for use where a lot of form-filling is done at many separate sites. Very little technical information was available beyond what was in last month's *Acorn User*.

Thorn-EMI had a rather flash little package containing both a 1200/75 modem and terminal software for the Beeb, intended to sell for about £140. Dealers are being sought now.

The Epson PX8 portable mentioned earlier has some beautiful ergonomic touches such as fold-out legs for tilting up the back and a fold-up liquid crystal display. It runs CP/M from tape cassettes with an optional 80k RAM-disc which bolts neatly on the bottom. Tandy watch out! *Alex van Someren*

## Chip camera for Beeb – a 'Snap' at £130

THE makers of the Beasty, Commotion, are set to release an add-on 'eye' for the Beeb. The £130 EV1, also known as Snap, is a chip-based video camera which plugs into the user port to produce a black and white picture on a mode 4 screen.

The EV1, pictured above, is about the size of a cassette case and uses a standard lens supplied with the miniature Pentax 110 SLR camera. A 64k light sensitive RAM chip acts as the camera's 'film', though only 32k of this is actually used to produce the picture.

The chip itself has had its protective case sliced off so that its silicon base is exposed to light. The picture is converted into a digital form and fed into the Beeb's user port.

The picture is formed on the

lower half of the screen and has a resolution of 128 pixels vertically by 256 pixels horizontally. Using suitable software a panoramic full-screen picture is possible.

The software to produce the picture sits in 2k of memory below Himem and is written in machine code. Also supplied with the EV1 is software to evaluate shapes. The camera produces an outline image of any objects in its field of view and then calculates their area, parameter and centre of gravity. Using this information programs can be written to enable the Beeb to recognise certain objects by comparing them with pre-programmed information.

Also available from Com-



by Bruce Smith

motion is the Beasty Arm at £32.95 (without servos). This robot arm can be supplied as a standard kit of parts or as a pick-and-mix set of modular parts. The arm consists of lengths of square section aluminium which fit into plastic housings. The Arm is interfaced to the user port via a Beasty (see Paul Beverley's review in May's *Acorn User*).

Software supplied with the arm allows the user to program a sequence of movements into the arm by editing them, as in a wordprocessor, into the main program. The arm will be supplied in kit form.

The EV1 and Beasty Arm will be available in the summer from Commotion at 241 Green St, Enfield, London EN3 7SJ.

## Coming soon: Z80 software in quantity

BUSINESS software for the BBC micro Z80 second processor is soon to be available in quantity from major UK distributor Software Limited.

Typical packages include the well-known *Wordstar* wordprocessor, *dBasell* database manager, *Supercalc* and nearly 300 others. Prices are the same as for versions to run on other machines, eg *Wordstar* for £295, *dBasell* for £438.

Software Limited have done all the necessary work, known as configuration, to allow the packages to be used as soon as you receive them. This involves providing the software on correctly formatted discs and alterations to allow use of the function keys on the BBC to replace the control-code combinations found on other micros.

Dealers will be provided with software by 24-hour Securicor delivery, and Software Limited will be providing

them with a telephone technical enquiry service. Under a contract with Software Limited, Acorn gave the company early access to the Z80.

Software Limited's marketing head Aidan Shackleton said: 'We believe that this contract with Acorn shows the way for future software distribution and co-operation between the hardware and software supplier.'

Shackleton also said preparations were being made to meet 'a huge demand' from users of CP/M on the BBC.

Dealers can contact Software Limited on 01-833 2601.

## Service deal set up by Acorn

KODE Services will provide on-site maintenance of all Acorn equipment within eight working hours.

Kode is claimed to be one of the country's largest maintenance contractors with engineers at six sites in the UK. Acorn's Customer Service Manager Mike Bicknell said: 'It's time Acorn provided the same servicing options to its major customers as other large computer manufacturers do'.

Kode contracts will not affect the normal Acorn guarantees. Non-dealer warranty repairs will still be taken care of by Retail Control Systems, Feltham, Middlesex.

Further details from Kode Services on (0249) 813771.

## GREMLINS HIT JUNE LISTING

THE GREMLINS have lost the end of a line of one of Paul Beverley's listings in last month's issue (yellow page vii, listing 2). Line 140 should read as printed below. Apologies to readers.

```
140 IF (?M% AND T%) > 0 THEN VDU255 ELSE VDU32
```

# Torch carries on with 'conflicting' products

TORCH is pushing ahead with its expansion plans despite being bought up by Acorn last month – and it looks set to continue giving its new parent a run for its money.

Neither company has announced any product cut-backs, and both appear to be carrying on as before. Vague proposals have been made for each to support the other's product ranges, but no definite decisions have been taken.

Several areas are set for conflict, however, the most immediate being the Z80 second processors. Torch had already sold about 6000 of its Z80 disc packs before Acorn's Z80 second processor was launched last month. Now it has made the Z80 card available separately for £263, which includes the Perfect range of CP/M-compatible software, undercutting the £299 offering from Acorn.

Another area of conflict is networking. Torch has Torchnet, an expansion of Acorn's Econet, while the parent also has involvement in two other networks.

But the big crunch is likely to come in the autumn with the launch of Acorn's business machine – or, more probably, machines. Both companies will then be supporting main-



**'The two companies have an exceptionally high degree of compatibility in products, in strategic thinking and in management style. We believe this new grouping will become a major British entry into the world market for communicating business systems' – Bob Gilkes, Torch chairman**

stream business systems, probably with similar specifications.

Torch already has its Winchester discs running (Acorn's are undergoing field trials), and a 68000 second processor, giving 32-bit processing (Acorn's equivalent to the 16032 is still not up to scratch).

The two companies have



**'Torch's established position in business systems is a natural outlet for some of Acorn's own business systems products, and a rationalisation of the two companies' development efforts will give a substantial boost to both Acorn's and Torch's market prospects' – Alex Reid, Acorn director**

long had close ties. At one time they shared offices and Torch was to be the business arm of Acorn. The two disagreed over policy and formal links were severed about two years ago – except one, that is: Acorn was contracted to supply Torch with BBC boards for its own range of computer products.

## Unicorn upgrades

TORCH has set out to tempt BBC owners along the upgrade path with a range of products under the 'Unicorn' banner – from a communications package to Winchester discs.

Unicorn kicks off the range at £185. It provides a BT-approved modem (OEL's Telemod) and software to access electronic mail and Prestel, as well as a mainframe link.

Next comes the Z80 second processor at £263, including bundled software, and the twin floppy disc pack combined with the Z80 disc pack at £699. Then come the two heavyweights.

First is the HDP240, a 20Mb hard disc pack. This also includes a 400k floppy disc

drive and can be connected direct to a BBC or via a network. A drive controller is included in the price of £1995.

Finally, there's the HDP68K, a hard disc pack with 68000 and Z80 processors built in. The 68000 chip handles 32-bit processing internally, but takes data in 16-bit chunks. This is the same chip as used in Sinclair's QL. Included in the box is a 400k floppy drive and 256k RAM.

Torch has implemented the Unix operating system on the 68000 and others are coming.

The 8088 chip, as used in the IBM PC, is already available in the Torch computer range, and so this is a likely contender as the next add-on processor for the BBC.

## Summer class for teachers

MUSE is to hold its annual summer course on computers in education at Nottingham University in July (23–25). Main speakers include John Coll of the MEP and Dr Max Bramer of the Open University.

There will be sessions on structured programming, BBC assembler, music, Logo, networking the Beeb and evaluating software.

The residential cost for the three days is £57.50, with a supplement of £11.50 for non-members. Details: MUSE, PO Box 43, Hull HU1 2HD.

## Beeb 'n' board

OCTOPUS is again running its BBC-based computer courses in the summer holidays. Each is made up of five half-day sessions, costing £40.25 or £150 full-board.

Details from Octopus, St Joseph's Hall, Junction Rd, Oxford OX4 2UJ.

## Legal entry

FOLLOWING the threat of legal action by Acornsoft over Silversoft's database, *Viewbase*, Silversoft has renamed its product *Index*.

*Index*, which costs £24.99, now embodies an enhancement which makes it possible to create a file, enter data and alter the file structure without corrupting data.



**LION'S SHARE** – Lion Microcomputers is giving away £20,000 worth of computing prizes during an Acorn Week at its Tottenham Court Road microcomputer centre in London on July 9-15. The event is being co-sponsored by Acorn and Mirrorsoft, the Daily Mirror's software division. Among the exhibitors will be Software Ltd, demonstrating a range of CP/M software, Micro-ware with new drives and Microvitec. Admission is by ticket.

# OUT NOW! 811 IDEAS FOR YOUR COMPUTER

NEW  
SAME-DAY  
DELIVERY  
IDEAS  
BOOK

In the Inmac catalogue of ideas for your computer check to see what is in the latest issue for you:

**Cables, cables and more cables!** How to order custom-built cables. When to use screened cables. How to choose the right EIA RS-232 extension cables for your VDU's and how to connect your Apple, Commodore, or other micros to Qume, Diablo, NEC printers. Compatible cables for connecting new peripherals to your DEC, Data General, Hewlett Packard, IBM, Osborne and Tandy computers.

**Lifetime Floppies** Read about Inmac Plus — the floppy with a lifetime guarantee! Choose from our range of 100% error-free disk cartridges, flag-free disk packs,

each with a 3-year replacement guarantee.

**New Ideas!** Dozens of exciting new products — many never seen in Europe before now — and lots of helpful hints on getting more from your computer department.

**Service and Quality — a promise you can rely on!** We promise a next day delivery service of our products, a 30-day risk-FREE trial, and a 12-month trouble-free quality replacement guarantee.

Send today for your FREE catalogue with no obligation to purchase — but be warned: you will want to buy once you have read the Inmac catalogue ideas book!



**FREE!** IF YOU USE A COMPUTER  
☎ 09285-67551/01 740 9450

Send this coupon to  
Dept.716, Inmac (UK) Ltd., Davy Road,  
Astmoor, Runcorn, Cheshire WA7 1QF.

Name \_\_\_\_\_

Company \_\_\_\_\_

Title \_\_\_\_\_

Address \_\_\_\_\_

Postcode \_\_\_\_\_ Tel. \_\_\_\_\_ 763

Computer System \_\_\_\_\_

24 hour tel. no.

☎ 09285-67551

### PRINTERS

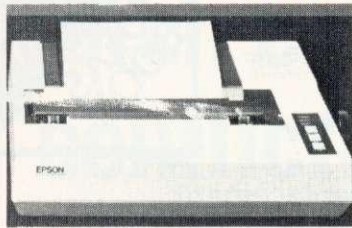

We have a range of printers that will meet most requirements. **EPSON**—the high quality dot-matrix printers that set the standard in the industry—versatile printers that provide the optimum in performance & reliability. The RX80/FT provides all standard printing & graphic functions, (single sheets & perforated paper), with the de-luxe FX80 giving in addition proportional printing, italics, programmable characters etc. The FX100 also allows the use of 15" wide paper. Epson DX100 — a new daisy wheel has the hallmark of Epson's quality performance and reliability. The **JUKI** daisywheel provides a quality normally found in printers costing far more. Printer cables, interfaces, ribbons, paper etc. are all normally available from stock.

**6502 2nd Processor & Bit Stick now in stock.**

### TORCH Z80 DISC PACK

The proven upgrade for the BBC Micro. Comprising 2 x 400K disc drive, Z80 processor with 64K of memory, and a CP/M compatible operating system, it opens up the vast range of CP/M software, including advanced languages, scientific and business applications. The system is supplied complete with the PERFECT software range including PERFECT WRITER, PERFECT SPELLER, PERFECT CALC, and PERFECT FILE. Full TORCHNET software is also supplied allowing sophisticated networking between other units. This will allow access to information, and communication, between up to 254 suitably upgraded BBCs.

**NEW TORCH Z80 PACK PRICE £699. SOFTWARE PACKAGE INCLUDES Z80 BASIC**

Phone for details about the 20Mbyte Hard Disc Pack, and the 68000 Hard Disc Pack with UNIX Operating System.

NOW AVAILABLE — The TORCH Z80 SECOND PROCESSOR CARD — for those who already have suitable disc drives. The card is supplied with all the free perfect software and Z80 basic, as detailed above, presenting a very attractive package. £299. Torch ZHD240 Mbyte Hard Disc + 400K Floppy. £1,995(a).

### RH LIGHTPEN

The Acorn-approved superior design, with a programmable 'push-tip' switch, status indicator LED and an interface box. Supplied complete with manual, full software and basic demo programs. £39(c). Demo program on disc £7(d). Colour graphics. Cassette £8.65(d) Disc £10(d).

### MICROTEXT

Developed by the National Physical Laboratory, is a program-ming system designed to simplify the production of a wide range of man-computer dialogues. Using MICROTEXT, an expert in any field can construct their own complete courses of computer-based instructional material. Applications include interviewing systems, teaching packages, training courses and interactive demonstrations and simulation. Cassette £43.35(c) Disc £52(c).

### GRAFPAD

A low cost graphic-tablet offering the performance and durability required for the business, industrial and educational user. It is small, accurate & reliable. Working area: 240 x 192mm + Menu area. £125 plus CAD program. £125(b).

### TELETEXT

Converts your BBC into a fully fledged Teletext Terminal. In addition to normal reception of Teletext pages, it is able to 'download' software as well as saving standard pages on any of the four TV channels. £196.

### ACORN COMPUTER SYSTEMS

BBC Model B	£348.00a
BBC Model B + Econet	£389.00a
BBC Model B + DFS	£429.00a
BBC Model B + DFS + Econet	£470.00a
6502 2nd Processor	£175b
Acorn Electron	£169.00b
BBC Teletext Receiver	£195.00a
BBC Dust Cover	£4.00d
Pair of Joysticks	£11.70c
Acorn Bit Stick	£328b

### TORCH Z80 SYSTEM

TORCH Z80 Disk Pack	£699.00a
TORCH Z80 2nd Processor Card	£299.00a
TORCH ZHD240 20MH	£1995a

### UPGRADE KITS

A to B Upgrade Kit	£60.00d
DFS Kit £95.00d	Installation £15.00
Econet Kit £55.00d	Installation £25.00
Speech Kit £47.00d	Installation £10.00

### ECONET ACCESSORIES

Printer Server Rom	£41.00b
File Server Level 1	£86.00b
File Server Level 2	£216.00b
Clock + 2 Terminators	£92.00b
Econet User Guide	£10.00d

### BBC FIRMWARE

1.2 Operating System	£7.50d
Basic II Rom	£32.00d
View Word Processor Rom	£52.00c
Wordwise W/P Rom	£34.00c
BCPL ROM + Disc	£87.00b
Disc Doctor Utility Rom	£28.00d
Termi Emulator Rom	£28.00d
ULTRACALC Rom (BBC Publications)	£65.00c
Gremlin debug Rom	£28.00d
Computer Concepts Graphics Rom	£28.00d
EXMON	£20.00d
TOOL KIT	£20.00d
Printmaster Rom (FX80)	£28.00d
Communicator Rom	£59.00c

### BBC ANCILLARY HARDWARE

EPROM Programmer	£89.00b
Smartmouth Speech Synthesiser	£37.00b
RH Light Pen	£39.50b
"Time-Warp" Real-Time Clock/Calendar	£29.00b
ACORN IEEE Interface ANK01	£282.00c
Buzzbox Modem	£69.00b

### PRINTERS & PLOTTERS

EPSON FX-80	£325.00a
EPSON RX-80 FT	£250.00a
EPSON FX-100	£480.00a
EPSON DX-100	£375.00a
Printer Sharer + Cable Set	£88.00c
JUKI 6100 Daisy wheel	£350.00a
MCP40 Col. Printer/Plotter	£110.00c
Accessories:	
Parallel Printer Lead	£10.00c
Serial Printer Lead	£8.00c
Epson Serial Interface 2K 8148	£60.00c
Epson Serial Interface 8143	£50.00c
FX80 Dust Cover	£4.00c
Epson Paper Roll Holder	£17.00c
FX-80 Tractor Attachment	£37.00c
PAPER Fanfold 2000 sheets	£13.50c
Ribbon MX80/RX80/FX80	£6.50c
Gemini Delta 10	£300.00c
Grafpad Graphics Tablet	£125.00c
Graphics Plotter/Workstation	£490.00c
Basic Plotter	£270.00c
PSU12	£45.00
PSU24	£79.00c
Power Adaptor Cable	£4.50c
Software on disc	£3.50c
Driller/Router	£79.00c
Opto Sensor	£72.00c

### COLOUR/GREEN MONITORS (leads incld)

Microvitec 1431 14" RGB Std Res	£179.00c
Microvitec 1431PS 14" RGB/PAL + Sound	£225.00c
Microvitec 1451 14" RGB Med Res	£295.00c
Microvitec 1441 14" RGB Hi Res	£420.00c
Microvitec 2031 20" RGB Std Res	£287.00c
KAGA Vision Ex 12" RGB	£195.00c
KAGA Vision II Hi Res	£260.00c
KAGA Vision III 12" RGB Super Hi Res	£358.00c
KAGA 12" Green Hi Res	£106.00c
SANYO DM812CX 12" Green Hi Res	£99.00c
KAGA RGB Lead	£6.50c
BNC Green Screen Monitor Lead	£3.00c

### BBC COMPATIBLE 5.25" DISC DRIVES:

(All include cables, manual + format disc)	
100K (40 Track) Teac	£135.00c
100K (40 Track) with psu Teac	£145.00c
200K (40/80 Track) Teac	£175.00c
200K (80 Track) with psu Teac	£190.00c
400K (80 Track DS) Mitsubishi	£190.00c
400K (80 TDS) with psu Mitsubishi	£225.00c
2x100K (40 Track) with psu Teac	£300.00c
2x200K (40/80 Track) with psu Teac	£400.00c
2x400K (80 Track DS) with psu Mitsu	£420.00c
3" Hitachi 100K Drive	£150.00c

**ALL PRICES EXCLUDE VAT. Please add carriage 50p**

### ACORNSOFT/MIRLE BUSINESS SOFTWARE

This long awaited range brings professional business software to the small business user at a budget price. Available on disc only, using genuine 'random access', each package can, if required, be linked together to provide a totally integrated business system. Modules comprise Invoicing, Order Processing, Stock Control, Accounts Receivable, Accounts Payable, Purchasing, Mailing System. Each package £22.65(d).

### MONITORS:

**NEW LOW PRICES**

**MICROVITEC**—a range of British Made DTI/ACORN approved Std/Med/Hi-resolution RGB colour monitors that have a consistent, reliable performance. Also available in RGB PAL/SOUND versions. The KAGA range provides a similar performance in 12" screen format. Our Japanese manufactured Hi-Res green screen SANYO is an ideal solution for high clarity 80 column text display. The KAGA green screen with its 'chemically etched' anti-glare screen for the discerning user. All monitors are supplied with suitable leads at no extra charge.

### BUZZBOX

This is a full specification, direct connect modem, with both Originate & Answer modes, allowing access to the many databases, bulletin boards, as well as inter-computer communication. The modem conforms to the international CCITT V21 300/300 Baud standard. (NOTE: Not suitable for PRESTEL). Having full BT Approval, it connects directly to the telephone line, for optimum performance. Being battery powered, it is totally portable (optional power supply available). £69. BBC Lead £3.50. External PSU £8.00

# Everything you need for your BBC Computer

## Plus friendly service and professional advice

<b>Accessories:</b>	
Single Disc Cable	£6.00d
Double Disc Cable	£8.50d
3M DISCS with Lifetime Warranty	
40T SS/SD Pkt of 10	£16.00c
40T DS/DD Pkt of 10	£22.00c
80T SS/DD Pkt of 10	£26.00c
80T DS/DD Pkt of 10	£30.00c
3" Double Sided Disc	Each £4.50c
FLOPPICLENE Drive Head Cleaning Kit	£14.50c
Disc Library Case	£1.90d
Disc File Case 30/40	£8.00c
Disc Lockable Case 30/40	£15.00c
Disc Lockable Case 60/70	£27.00c
<b>EPROMS:</b>	
Please phone for availability	
<b>SOFTWARE:</b>	
ACORN/MERLE BUSINESS SOFTWARE	
Invoicing, Stock Control, Accounts Payable, Accounts Receivable, Order Processing, Mailing System	
	Each £22.65d
GEMINI Business - Full Range	
ACORNSOFT - Full Range	
ACORN LANGUAGES including BCPL, LISP	
FORTH with Manuals	
BBCSOFT - Full Range	
PROGRAM POWER - Full Range	
BEEBUGSOFT - Full Range	
Wordwise Spellcheck Disc	£16.50d
Design	£16.50d
Superplot	£16.50d
Masterfile (Database)	£16.50d
Teletext Pack (Mode 7 Graphics)	£16.50d
<b>CASSETTE RECORDERS:</b>	
SANYO DR101 Data Recorder	£30.00b
Datex Slim Line	£20.00c
BBC Tape Recorder	£28.50b
Cassette Lead	£3.00d
Computer Grade C-12 cassette	£0.45d
Computer Grade Cassette 10 off	£4.00c
Phillips Mini-data cassette	£3.00d
<b>BOOKS (NO VAT) p+p £1.50/book</b>	
Let Your BBC Teach U To Prog	£3.50
BBC Micro Revealed	£3.00
100 Programs for the BBC	£6.95
30 Hour Basic	£5.95
35 Educational Progs	£6.95
6502 Applications	£9.75
6502 Assembly Lang Programming	£12.95

6502 M/Code for Beginners	£5.95
6809 Assembly Lang Programming	£13.95
Advanced Prog Tech for BBC	£7.95
Advanced 6502	£10.25
<b>Advanced User Guide</b>	<b>£12.50</b>
Assembly Lang Pro on the BBC	£7.95
Assembly Lang for the BBC	£7.95
Assembly Lang Prog for Electron	£7.95
Assembly Lang Programming	£8.95
Basic Prog on the BBC	£5.95
BBC Basic	£5.95
BBC Basic for Beginners	£6.95
BBC Micro for Beginners	£6.95
BBC Micro Compendium	£14.95
BBC Micro Disk Companion	£6.95
BBC Micro Expert Guide	£6.95
BBC Micro Graphics & Sound	£6.95
BBC Micro in Education	£6.50
BBC Micro Revealed	£5.00
BCPL User Manual	£15.00
Beyond Basic	£7.25
Creating Adventure Progs	£6.95
Creative Graphics	£7.50
DIY Robotics & Sensors	£6.95
Discovering BBC M/Code	£6.95
Forth	£7.50
Friendly Computer Book	£6.95
Graphics on the BBC Micro	£6.95
Graphs & Charts	£7.50
Interfacing the 6502	£10.95
Intro BBC Micro	£5.95
LISP	£7.50
Making Music on the BBC Computer	£5.95
Micro Basic Sound Graphics	£7.95
MOS Memory Data Book	£3.95
Prog the BBC Micro	£6.50
Programming the 6502	£9.95
Programming the 6809	£11.35
Programming the 8086/8088	£10.95
Programming the BBC	£6.50
Programming the Z80	£9.95
Start Prog with Electron	£6.95
Structured Programming	£6.50
The Computer Book	£5.95
The Electron Book	£7.95
TORCH Z80 Disc Pack Guide	£10.00
TTL Data Book Vol-1	£9.00
TTL Data Book Vol-2	£8.50
BBC User Guide	£15.00
Using BBC Basic	£10.00
Using Floppy Disks	£6.95
Using the 6502 Assembly Lang	£14.50
Z80 Applications Book	£10.95

**MANY MORE BOOKS IN STOCK**

## ULTRACALC

With advanced features, such as: \*Handling of labels as well as numbers, as values, allowing the search of a list by a meaningful name, instead of just a number. \*Efficient memory usage allowing large spreadsheets to be constructed. \*Variable width columns. Facilities include SUM, Replicate & most mathematical functions. It helps you to create and manipulate \*Budgets \*Cash-Flow forecasts \*Price Lists \*Balance Sheets \*Time Sheets \*Order Entry \*Small Databases \*Scientific Calculations etc. **£65.**

## DISC DRIVES:

A full range of disc drives fitted with quality Japanese slimline mechanisms, (such as TEAC, MITSUBISHI etc.) are supplied ready to connect to your BBC, and come complete with necessary cables, formatting disc, manual etc. TEAC & MITSUBISHI mechanisms can operate in single and double density modes. The switchable disc drives give the user flexibility, by allowing access to both 40 & 80 Track discs. We have a full range of diskettes, variety of disc storage cases, disc-drive cables. The Floppicleene head cleaning kit, is the ideal way to ensure optimum performance of your drives. The use of disposable cleaning discs eliminate the risk of recontamination and abrasion, and ensure continuous data capture and transmission.



## KENDA DMFS

A truly professional double density DMFS with several unique features:- \*requires no RAM i.e. PAGE=&E00 \*uses standard CP/M filenames & disc drive conventions \*no limit to number of files \*single/double density automatically selected \*runs most 'protected' software \*enables 80 Track drives to read 40 Track discs.

## SCOTCH 3M FLOPPY DISCS

to advanced production techniques, a higher standard has now been reached, enabling Scotch to guarantee error free performance for life.

## 3" HITACHI DISC DRIVES

The latest in miniature data-storage technology. Totally hardware & software compatible with 5 1/4" drives (can be used together!). Supplied complete with format disc, manual, cables etc. **£150(b).**

## ACORN IEEE INTERFACE

A full implementation of the IEEE-488 standard, providing computer control of compatible scientific & technical equipment, at a lower price than other systems. Typical applications are in experimental work in academic and industrial laboratories. The interface can support a network of up to 14 other compatible devices, and would typically link several items of test equipment allowing them to run with the optimum of efficiency. The IEEE Filing System ROM is supplied. **£282.**

Continued on page 14

## INSTITUTIONS & EDUCATIONAL ESTABLISHMENTS

Our bulk purchasing power enables us to provide very competitive quotations, as well as being able to supply in quantity, a very wide range of equipment, accessories and spare parts from stock.

## GRAPHICS PLOTTER/WORKSTATION

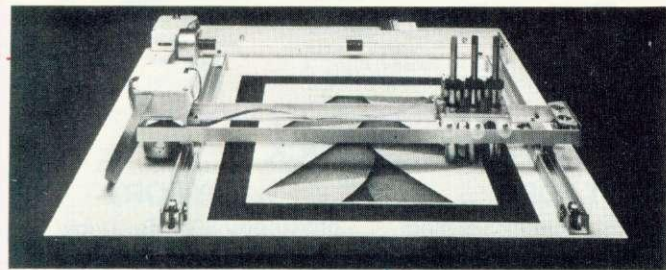

Equally at home in the artists studio, hobbyists workshop, science laboratory, classroom, and production floor, this system has something to offer everyone. The 3-colour graphics plotter provides both precision and versatility. The carriage can be moved with an accuracy of 0.025 cm. over an A4 area - the plotter being able to accept paper and far thicker materials at sizes of up to A3. The basic colour plotter carries three colour pens each of which is software selectable. Various add-ons greatly increase the versatility of the unit, while still retaining the unit's accuracy. The servo controlled drill/router, and a scriber enables drilling, cutting and scribing in various materials. A unique Opto Sensor (using a Hewlett Packard Device) turns the plotter into a high resolution scanning digitiser to read and store whole diagrams, for example, for use in map work. This unique versatile Workstation is supplied complete at **£490.** Basic Plotter **£270.**

MAIL ORDERS TO: 17 Burnley Road, London NW10 1ED  
(Tel: 01-452 1500, 01-450 6597 Telex 922800)

SHOPS AT: NW London: 15 Burnley Road, London NW10 1ED  
(Dollis Hill 2 mins walk, ample car parking space)

West London: 305 Edgware Road, London W2. Tel: 01-723 0233  
(Near Edgware Road)

## TECHNOMATIC LTD.

All prices exclude carriage & VAT. Please add carriage as indicated and add 15% VAT to the total order value. For fast delivery telephone your order quoting VISA or Access card or official order number. (Minimum telephone order £5).

### EPROM PROGRAMMER:

A fully self-contained mains-powered eprom programmer housed in an attractive finished case. It is able to program 2716, 2732/32A, 2764 & 27128's in a single pass. It is supplied with vastly superior software when compared to any currently available similar programmer. In addition to normal eprom programming, you are now able to load your favourite basic programs onto eprom.

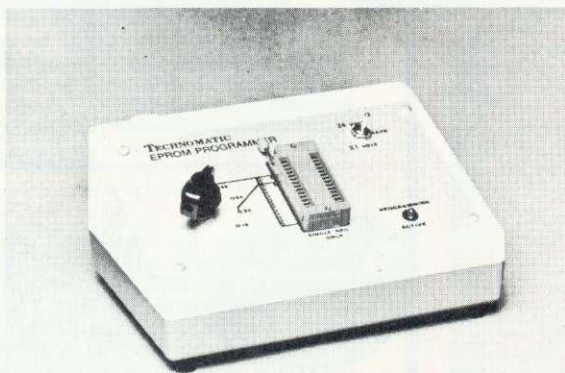

The programmer comes complete with cables, software & operating manual.  
**£89 + £2.50 carriage. Software on disc £2 extra.**

- \* Menu Driven Software provides user friendly options for programming the eprom with:
  - a) Basic programs.
  - b) Ram resident programs.
  - c) Any other program.
- \* Programmer can read, blank-check, program & verify at any address/addresses on the Eprom.
- \* Personality selection is simplified by a single rotary switch.
- \* Programming voltage selector switch.
- \* Full Editor with ASCII Disassembler, allowing direct modification of memory data in HEX or ASCII.
- \* Continuous display of time left for completion of programming.
- \* Continuous display of current addresses as they are being programmed.

### EPROM ERASERS



UV1T Eraser with built-in timer and mains indicator. Built-in safety interlock to avoid accidental exposure to the harmful UV rays. It can handle up to 5 eproms at a time with an average erasing time of about 20 mins. **£59 + £2 p&p.**  
 UV1 as above but without the timer. **£47 + £2 p&p.**

**SPECIAL OFFER**  
**EPSON FX 80**  
**PRINTER**  
**ONLY £325**

including BBC printer lead  
 Twelve Months full warranty.  
 Offer valid while stocks last.

### SMARTMOUTH:

The original 'infinite speech'.  
 Still the best.

A ready built totally self contained speech synthesiser unit, attractively packaged with built-in speaker, AUX output socket etc.—no installation problems! It allows the creation of any English word, with both ease and simplicity, while, at the same time being very economical in memory usage. You can easily add speech to most existing programs. Due to its remarkable infinite vocabulary, it uses spread throughout the whole spectrum of computer applications—these include industrial, commercial, educational, scientific, recreational etc. No specialist installation—no need to open your computer, simply plugs into the user port—and due to the simple software, no ROMS are needed. SMARTMOUTH is supplied with demo and development programs on cassette, and full software instructions. **£37+ £2.50 carriage.**



### 'TIME-WARP' REAL-TIME-CLOCK/CALENDAR

A low cost unit that opens up the total range of Real-Time applications. With its full battery backup, possibilities include an Electronic Diary, continuous display of 'on-screen' time and date information automatic document dating, precise timing & control in scientific applications, recreational use in games etc—its uses are endless and are simply limited by one's imagination. Simply plugs into the user port—no specialist installation required—No ROMS. Supplied with extensive applications software. **Please phone for details. £29.00 + £2.50 carriage.**

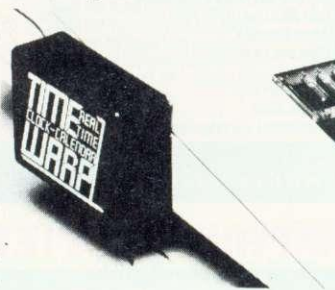

### ELECTRON ADD ONS NOW IN STOCK

#### PRINT PORT

- \* Suitable for most centronics printers
  - \* Supplied complete with lead & programming.
- £39 + £1.50 p&p**

#### JOY PORT

- \* Controls over 80% of available arcade games.
  - \* Uses ATARI Style 9 pin joysticks
  - \* Just plugs in—no soldering
  - \* Does not overload Electron psu
- £14.75 + £1.60 p&p**

### BEEBUGSOFT

A professional range of Firmware/Software to suit both the advanced programmer and the user. From the well known 'EXMON' and 'TOOLKIT' to the WORDWISE SPELLCHECK.

See our double page spread advertisement on pages 12 and 13.

MAIL ORDERS TO: 17 Burnley Road, London NW10 1ED  
 (Tel: 01-452 1500, 01-450 6597 Telex 922800)

SHOPS AT: NW London: 15 Burnley Road, London NW10 1ED  
 (Dollis Hill 2 mins walk, ample car parking space)

West London: 305 Edgware Road, London W2. Tel: 01-723 0233  
 (Near Edgware Road)

## TECHNOMATIC LTD.

All prices exclude carriage & VAT. Please add carriage as indicated and add 15% VAT to the total order value. For fast delivery telephone your order quoting VISA or Access card or official order number. (Minimum telephone order £5).



# Vikings and maths in learning games

A 'MATHEMAGICAL' adventure called simply *L* is the latest creation of the Association of Teachers of Mathematics.

*L* aims to provide the appeal of a computer adventure based on puzzles and questions, without resorting to blood and slaughter.

*L* is aimed at school and home. It is supplied on 40-track disc for £10 by ATM, Kings Chambers, Queen Street, Derby DE1 3DA.

Dial Software has released two educational items, *Child's Play Pack* and *Spellwell*. The former is aimed at young children and contains four programs combining colourful graphics and speech on machines that have a speech synthesiser fitted. The latter is a spelling drill for all age groups, with five levels and a dictionary that the teacher or

parent can modify as the pupil's vocabulary increases.

*Happy Writing* from Bourne Educational runs on the BBC, Electron and, interestingly, the Amstrad CPC 464. It is designed to help children learn to write and combines animation, colour graphics and sound to keep the child's attention.

Fernleaf Software has a September launch planned for its *Viking England* package. This comprises four inter-linked programs to be used as part of a larger history project by children aged 9-13.

The children need to organise a raid, make a landing, explore inland and eventually settle down and try to develop a prosperous culture in Britain. Fernleaf Software is at Fernleaf House, 31 Old Road West, Gravesend, Kent DA11 01H.



## Wordwise to run on Aries board

WORDWISE, the wordprocessor on a chip from Computer Concepts, has been updated to make use of the Aries B20 RAM board.

This means *Wordwise* can be used with an 80-column display without losing text space. Computer Concepts will upgrade a *Wordwise* for £10.

*Caretaker* is Computer Concepts' Basic utility ROM. This provides extra commands to help de-bug and develop programs. It costs £33.35.

## Chip helps ROMs

MANAGER is a chip from Watford Electronics for users of sideways ROMs, and programmers who want to put software into EPROM.

It supplies extra information about some of the \*FX commands, and the ability to select ROMs, so avoiding any clash of commands.

The chip should be available now at an initial special offer price of about £21.

15

### HARDWARE AND SOFTWARE

## Micro-Aid

### FOR THE BBC MICRO

SOFTWARE - Programs that are guaranteed to run! Save hours of work and worry with these utilities, educational & business programs on cassette or disc.

102	CASHBOOK	Double entry 4 columns with accounts & analysis	£11.95	B	520	BANNER	Print giant text and graphics on paper for displays	£3.95	A/B
102d	CASHBOOK	Full disc version. 1200 items on 100k disc	£19.95	B	521	BIGLETR	Print as above on screen/paper with screen dump	£5.95	A/B
103	LEDGER	Complements CASHBOOK with ageing & analysis	£11.95	B	600	FORTH	'79 FORTH second language ROM	£34.74	B
105	MAILING	Holds 218 addresses. Alpha & post code sorts, searches, any label format, delete, add and amend	£11.95	B	601	LOGO-FORTH	Advanced Turtle Graphics Language ROM with FORTH	£57.50	B
106	PAYROLL (W or M)	In 2 parts to handle weekly or monthly (state which) PAYE & NI for 100 employees. Fully supported	£24.95	B	602	PASCAL-T	Structured language ROM with compiler-interpreter	£57.50	B
107	MEMO-CALC	Database/Calcsheet with up to 255 columns, string or numeric data, sorts, searches, calculations.	£12.95	B	603	XCAL	Computer Assisted Learning ROM for presentations	£65.00	B
201	GAMES 1	5 Card, Minefield, Darts, Pontoon & Mr. Midon	£5.95	B/E	605	WORDWISE	Superb fast & easy to use wordprocessor in ROM	£33.95	B
202	STOCKMARKET	Exciting world of Stocks and shares, 1-4 players	£5.95	B/E	606	CDUMP	Screen dump, 8 colours, suitable for GP700A	£12.95	B
301	HANGMAN	Word game in English, French, German, Italian, Spanish	£7.95	B	607	GDUMP	Screen dump ROM, 8 shades, 8 sizes and windows	£17.95	B
302	DISTANCES	Three graphic maps of U.K., EUROPE & the WORLD. Calculate the distance between any 2 places	£4.95	B/E	608	DISKDOC	ROM for disk problems in format, search, files etc.	£27.50	B
303	FLAGS	98 full colour flags of the world with questions	£4.95	B/E	608	GRAPHICS	NEW ROM for Sprites, LOGO, circles, fill etc.	£27.50	B
304	STATPACK	Statistics package giving over 30 results	£9.95	B	700	BOOKS	Various titles for the BBC Micro from	£6.95	
305	GRAPH	Produce varied graphs & charts of functions	£7.95	B	801	CASSETTES	C15 Computer quality tapes packed in 10's	£4.50	
306	FRENCH	New audio visual computer way to learn a language	£7.95	B	810	5.25" DISCS	MEMOREX: SS/SD 40/80T	£19.95	
307	SPELL-CHECK	Add to WORDWISE. 15000 words in 12 dictionaries	£17.95	B			SS/DD 40/80T	£20.95	
504	PROCAID	includes SEARCHBAS to search a BASIC program and alter it, PROCVAR to list variables in a BASIC program & PROCFLUSH to clear resident integers in RAM	£3.45	A/B	900	SEIKOSHA	GP700A 7 COLOUR 30 shade dot matrix printer 50cps	£369.00	
505	UTILITY-A	Our best selling tape includes PROCAID, DEFCHR to design & display graphic characters. SORTM/C a very fast machine code numeric sort, SORTBAS the undisputed fastest BASIC sort routine	£5.95	A/B	901	EPSON RX-80 T/F	Superb. 100cps with Tractor & Friction feed	£275.00	
					902	EPSON FX-80	Magnificent. 160cps, 6 founts, graphics, F/T Roll	£365.00	
					910	DISC DRIVES	Slimline 3" or 5 1/4" 100k - 800k Japanese. Format disc, cable and excellent manual.	£189.00	
					915	DISC UPGRADE	Double & Single Density available in one system	£77.50	
					920	VDU STAND	Stainless Steel Support protects your micro	£19.95	
					930	GREEN VDU	12" Green Monitor, cream sloping front case	£79.95	
					931	COLOUR VDU	JVC 14" Colour Monitor 370 x 470 pixels	£179.95	
					950	SAT-16 MPU	16 bit 68000/68701 stand alone computer from	£570.00	

BUDGET: £9.95

CRIB: £7.95

RANDOM ACCESS MAILING: £24.95.

ADD £1.75 FOR PROGRAMS ON 40 OR 80 TRACK DISC. NO POST CHARGE IN UK. MOST PROGRAMS AVAILABLE ON MICRONET 800.

ADD VAT TO ALL PRICES EXCEPT BOOKS.

Micro-Aid (AU)

25 Fore Street, Praze, Camborne, Cornwall TR14 0JX.

Tel: 0209-831274

Send for our free brochure for more information before parting with your money.

NEW  
SEIKOSHA  
PRINTERS

from  
£138

# Caretaker

## BASIC Utility ROM

CARETAKER is a BASIC utility ROM which provides many new invaluable commands to help the BASIC programmer. Because CARETAKER is in ROM, it uses no BASIC program space and its commands are always instantly available. Some of the CARETAKER commands are detailed below:

- EXCHANGE** - provides a search and replace facility, either global or selective. 'Wildcard' characters and BASIC keyword tokens may be included.
- EXPAND** - Lists a program in an easy-to-read form, also allowing 'squashed' programs to be read.
- INSERT** - Enables BASIC routines on disc or tape to be inserted into or added to the program in memory.
- KEYLOAD** and **KEYSAVE** - Load and save the function key definitions.

- LVAR** - Lists the values of all or some of the variables.
- MERGE** - Will merge one or more BASIC programs on file into the program in memory.
- MOVE** - Allows the current BASIC program to be moved to a new page in memory.
- PARTSAVE** - Saves only a selected section of a BASIC program (useful for later merging).
- RENUMBER** - Renumbers parts of BASIC programs and moves the renumbered section as necessary.
- RETRIEVE** - Restores a corrupted program to a form in which it can be listed and edited.
- SINGLEKEY** - Enables BASIC keywords to be entered quickly, as on the ELECTRON.
- SQUASH** - Reduces the size of a BASIC program in order to save memory space. A very efficient routine.
- STATUS** - Displays the values of PAGE, HIMEM, program length, bytes free, etc.
- TABSTOPS** - Provides a tabulation facility. Up to eight tabstops can be defined.

CARETAKER is supplied with a spiral bound manual, special 'single-key entry' stickers for the key fronts, and easy-to-follow fitting instructions. A full specification is available upon request.

```
*HELP CARETAKER
CARETAKER 1.00
CURSOR (ON/OFF)
EXCHANGE <old> <new> G/S <<length>>
EXPAND <<start>> <<end>>
INSERT <fsp> <<lineno>>
KEYLOAD <<fsp>>
KEYSAVE <<fsp>>
LVAR (F)(I)(S)(A)(P)
MOVE <address>
MERGE <fsp> <<fsp>>...
NORMALKEY
NOTAB
PARTSAVE <fsp> <<start>> <<end>>
RENUMBER <<1st> <inc> <start> <end>
RETRIEVE <<bytes>>
SINGLEKEY
SQUASH (S)(R)(M)
STATUS
TABSTOPS <<columns...>>

OS 1.20
>
```



# New Release

£33.35 incl.

# The Most Popular Word Processing ROM for the BBC Micro

# Wordwise

£46.00 incl.

WORDWISE is ideal as an introduction to word processing for the beginner, but is a powerful enough tool to be used seriously by professional authors (at least two of the most popular BBC Micro magazines are prepared entirely with WORDWISE). Being entirely ROM based it occupies none of the memory which is used to store text. It will operate fully on cassette, disc or ECONET (level II). It is not specific to any particular printer, nor does it require a special printer-driver (an expensive extra on some word processors). WORDWISE allows any codes to be sent to any printer, at any point within the text, by using a simple 'embedded command'.

For the beginner, text can be typed straight into WORDWISE and saved, loaded, previewed or printed immediately. Once experience is gained, commands may be added to control the final layout on paper. Some of the layout or 'formatting' commands are described later. At any time whilst the text is being entered or edited a word count is displayed continuously on the top line. Labelled function keys provide the user with simple controls to mark any section of text and then delete, move or copy it to any other position. Characters can be quickly converted between upper and lower case; changing case of entire paragraphs is equally simple.

```
WORDWISE
(C) Computer Concepts 1982

1) Save entire text
2) Load new text
3) Save marked text
4) Load text to cursor
5) Search and Replace
6) Print text
7) Preview text
8) Spool text

ESC Edit Mode

Please enter choice_
```

Moving around the text is simple. Cursor keys alone move one position in any direction; CTRL and cursor keys together move in larger steps, a word left/right, a page up/down; SHIFT and cursor keys move as far as possible to the right/left of the line or to the start/end of the entire text. These movements are so easy to use that many other programs have adopted exactly the same method.

Formatting commands include the ability to split the document into pages of any length, with or without headings or footings. Page numbers may be printed automatically within the text, including within headings and footings. Commands are provided to set (at any point in the text) line length, left margin, tabulation positions, line spacing etc. Text can be centred on a line, indents and temporary indents can be set and cancelled. Output can be made to automatically pause at the end of a page, e.g. for a single-sheet feed. Right justification of text can be turned on and off at any points in the text.

User-defined keys may hold any required string as normal and used within WORDWISE, including the codes required to induce key operations such as cursor movement.

**ARIES compatible WORDWISE**  
A new version of WORDWISE is available upon request at the standard price which is fully compatible with the ARIES B20 RAM board. When fitted alongside the compatible WORDWISE, the ARIES board allows text to be previewed in 80 columns even with the normal RAM full of text. An upgrade from the standard version of WORDWISE is available. Please ask for details.





# MICROMAN Computers

ACORN SPECIALIST COMPUTER CENTRE



### ACORN/BBC COMPUTERS:

Acorn Electron	199.00
BBC Model B	399.00
BBC Model B + DFS	469.00
Acorn Teletext Receiver	225.00
Acorn 6502 2nd Processor	199.00
Acorn Z80 2nd Processor	299.00
Acorn IEEE Interface	325.00
Bitstick	375.00

### BBC UPGRADES:

A-B Upgrade (Fitted)	95.00
DFS Interface (Fitted)	109.00
Speech Synthesizer (Fitted)	55.00

### PRINTERS:

Epson RX80FT	295.00
Epson FX100	574.95
Star Gemini 10X	268.00
Star Delta 10	385.00
Cannon PW-1080A	330.00
Shinwa CP80	220.00
Sanple Daisywheel Printer	332.35

### TORCH COMPUTERS:

Z80 Disc Pack	799.00
Z80 2nd Processor Card	339.00

### BBC FIRMWARE:

View ROM	59.80
Wordwise ROM	44.85
Viewsheet ROM	59.80
B-Base Database Disc	25.00
UltraCalc Spreadsheet ROM	POA
Computer Concepts 'rom	33.35
Toolstar ROM	34.00
Commstar EPROM	34.00
BCPL ROM	99.65
Sidewise ROM	44.70
Solidisk 32K Sideways RAM	
	57.95
Solidisk 96K Extension	92.00
Solidisk 128K Sideways RAM	149.95

### MODEMS:

Grapevine/Commstar Modem	136.85
--------------------------	--------

### MONITORS:

Decca RGB Standard	228.85
Microvitec Cub Standard	228.85
Zenith Green	109.25
Decca TV/Monitor	265.00

### DISC DRIVES:

Full range available	POA
----------------------	-----

WE HAVE A RANGE OF BUSINESS & WORD PROCESSING PACKAGES BASED AROUND THE BBC & TORCH COMPUTERS

ACORN APPROVED SERVICE CENTRE  
Our workshop offers a comprehensive service including Repairs and Upgrades by our own engineers

### EDUCATIONAL ENQUIRIES WELCOME



All prices include VAT, Post & Packing £9 (Large items) £1 (Small items ROM's etc)



RAINFORD INDUSTRIAL ESTATE, MILL LANE,  
RAINFORD, ST. HELENS, MERSEYSIDE

PHONE 074488 5242

INCREDIBLE ANIMATION BROUGHT TO YOUR BASIC PROGRAMS

## SIMONSOFT SPRITES VERSION TWO

@ £12.95 for the BBC 32K and the Electron  
£15.95 on 40 or 80 track disc

An 18-FOLD INCREASE IN SPEED (BBC) of your own character designs makes this the FASTEST EVER screen movement seen in Basic programs. Amazing animation effects are available at a command, yet no knowledge of machine code is required. This incredible extension to your machine's facilities is RAM based and your whole program can be SAVED/LOADED at the same time as the control coding and sprite images (your character designs). The designs and the control routine need take as little as &600 (1.5K) from the memory of your machine!

### LOOK AT THESE FEATURES:

1. **SPRITE GENERATOR PROGRAMS** to create your own sprite designs. All 16 colours may be used in each design, with characters as small as one pixel or as large as the 24 x 24 pixel SUPERSPRITE. As you design the sprites they are automatically stored in the machine code control routine so that you can delete the generator program before writing your own Basic.
2. **UPTO 48 SPRITES ON SCREEN** with 12 separate sprite designs, each with 3 independently controlled clones.
3. **INSTANT ANIMATION** with two images in each sprite design. These are switched automatically as the sprite crosses the screen, allowing effects such as hopping frogs, running men, etc.
4. **COLLISION DETECTOR** with a hit flag that is set to the number of any sprite overlapping with the sprite just moved. When the sprites move apart, there is no disruption of the sprite character designs.
5. **ENLARGEMENT FACILITY** of x2, x3, x4, x5 magnification of the sprite size! Let your invaders loom out of the screen in 3D effects - or use enlarged sprites throughout your program!
6. **FOUR PRESET FLIGHT PATHS** designed from the generator programs. Each path has 8 definable directions, with up to 255 steps allowed in each direction. Once sprites have been allocated to a path, they will move automatically as your program runs.
7. Both EOR and TRANSFER plotting of sprites to the screen are available.
8. A **SPRITE LIBRARY** has sprite designs ready for use in your programs with 'books' such as 'GHOSTS' and 'MEN'.
9. **SPRITE POSITION COORDINATE VARIABLES** which are reset automatically by the control coding if the sprite crosses a screen boundary. As you move your designs, the 'old' images left behind are deleted automatically as well.

This amazing package includes control routines containing different combinations of the above features - choose the routine best suited to the program you want to write. A comprehensive colour manual, an introduction program and two arcade style demonstration games are also included in the package. Compatibility with all other BBC make our animation routines ideal for serious programmers - and we won't claim royalties on programs you market using sprites!

N.B. Disc version may be bought on cassette for transferral to disc.

**SUPERFRUIT @ £5.95 for the BBC 32K and the Electron  
£8.95 on 40 or 80 track disc**

Simply the best. Full colour high resolution graphics. Spinning reels with 'bounce'. Incredible gamble effects, hold, 3 types of gamble, swap reels, two-way nudge, nudge gambles, coin pile that shrinks/grows, great sound effects. Separate instruction program. This implementation is in a class of its own.

"You would be fully justified in claiming that it is better than the real thing" - M. Field, Oxford.

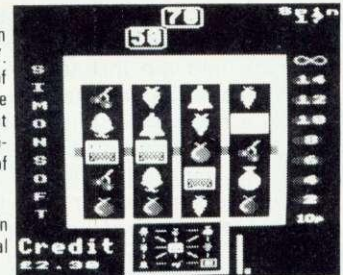

Screen photograph



**CASTAWAY @ £8.95 for the BBC 32K, £11.95 on disc  
The Three Island Adventure**

A beautifully designed adventure with a wealth of puzzles of logic, imagination and wit. Tackle beanstalks, irate gardeners and priggish chemistry teachers! Brilliant use has been made of sound and Mode 7 graphics with full screen pictures. Set in varied terrain, from sanddunes to mansions, the adventure provides an exciting range of locations through which the castaway must pass in search of priceless treasure and cryptic clues.

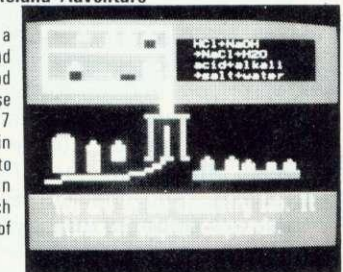

Screen photograph

To order send cheque/P.O. to:

**SIMONSOFT, 25 TATHAM ROAD  
ABINGDON, OXON OX14 1QB  
TEL: 0235 24140**

PROGRAMMERS - WE PAY 30% ROYALTIES FOR  
EXCELLENT PROGRAMS

32k BBC or Electron  
Pilot written.....



# 767

ADVANCED  
FLIGHT SIMULATOR

Comprehensive, well documented package. This is undoubtedly the most advanced, realistic simulation for 32kBBC/Electron superb graphics - full instrumentation, 3D landing sequence, autopilot, ILS, VOR etc. Joystick option. When you have flown 767 the only next step is the real thing!

Mail order only  
Guaranteed by  
return  
Chq. or PO  
£8.75



FLIGHTDECK  
SOFTWARE,  
Dept. 767,  
25 Halsey Road,  
Kempston, Beds. MK42 8AP

# EXPANSION FACTOR

## What does the Plus-1 add to the Elk?

### Bruce Smith makes the connection

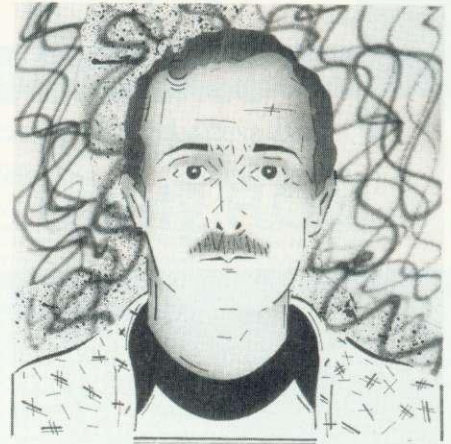

18

**P**LUS-1, the long-awaited Acorn interface for the Electron, has arrived, and without any of the delays that beset the computer industry these days. It adds the following capabilities to the Elk:

- Two cartridge slots for ROM-based software.
- A parallel printer port.
- Four eight bit analogue-to-digital input channels.

Aesthetically the interface is without frills but it complements the Electron to provide a neat and professional unit. Connecting the Plus-1 to the Elk is extremely simple and no difficulty should be encountered.

First, the plastic cover on the expansion bus must be removed to expose the edge connector. With both units upside-down, the protruding front edge of the interface is pushed over the expansion bus and into the recess at the rear underside of the computer.

Fixing the Plus-1 to the Elk is done with the aid of a coin! Two large bolts locate into the threaded holes in the Elk's case. The connection is firm and only a slight flexing is possible, so no problems with data corruption should be encountered. Once in place, the Plus-1 adds another 100 millimetres (4in) to the depth of the computer.

Externally there are four ports, two for the cartridge software and one each for the printer and ADC connector. Internally the main printed circuit board is more spaciouly laid out than previous Acorn boards. Software for the Centronics printer interface, the ADC drivers and for downloading cartridge software were contained within an EPROM version 1.00 on the review model. Apart from the ADC chip, an ADC0844, and the OS EPROM, all chips are soldered directly to the main PCB.

The ROM cartridges can provide a variety of applications, including games, utilities and paged languages. Supplied with the review model were the six cartridges currently available: *Snapper*, *Hopper*, *Starship Command*, *Tree of Knowledge*, *Countdown to Doom* and *Lisp*.

Two sprung flaps on the rear mark the cartridge ports. A cartridge is inserted through a flap and into the

socket at the base. If two cartridges are inserted the nearer of the two has the higher priority and will be selected.

Once in position cartridge software is Chained simply by pressing the Break key, which boots the first file on the cartridge. Language ROM cartridges—*Lisp* in the review bundle—are switched in at &8000 and therefore replace Basic, which can be reselected by removing the language cartridge or typing \*BASIC.

The filing system used by the ROM cartridge system is in fact the \*ROM filing system (RFS) as used on the Beeb, making it a simple task for commercial establishments to blow their own cartridge ROMs. \*CAT, LOAD and CHAIN are all available with the RFS.

The ROM cartridges themselves are neat, slightly smaller than a cassette and the plug-in portion is a PCB edge connector. An interesting aspect of their design is that the silicon itself has been bonded onto the main PCB and coated with plastic to protect it, thereby doing away with the more expensive standard ROM packaging.

The printer port is a standard Centronics compatible parallel interface. CTRL B (VDU2) and CTRL C (VDU3) 'switch' the printer on and off for print-

ing purposes, while VDU1 will send control characters to the printer. I had no problem using my Star Delta, and my screen dumps performed correctly. Several \*FX commands are included within the Plus-1 OS to help matters.

The most obvious use of the analogue interface for the home user is for connecting a joystick. Most of the games ROM cartridges are joystick-compatible and my Voltmace stick performed as expected, and any joystick with an impedance of at least 10 ohms would be suitable.

The ADC channels can be read from Basic using the ADVAL command, while \*FX16 allows channel selections to be made. The analogue port also allows various peripherals to be interfaced to the Electron, provided they are electrically compatible.

Full details on using the ADC and printer ports and on the cartridges are provided in the Plus-1 *User Guide*. The 22-page spiral-bound volume also contains lucid accounts of connecting the Plus-1 to the Elk.

The price of the Plus-1—£59—represents good value for a very useful unit. Acorn has got its sums right with the Plus-1, and it must be the first serious buy for an Electron owner.

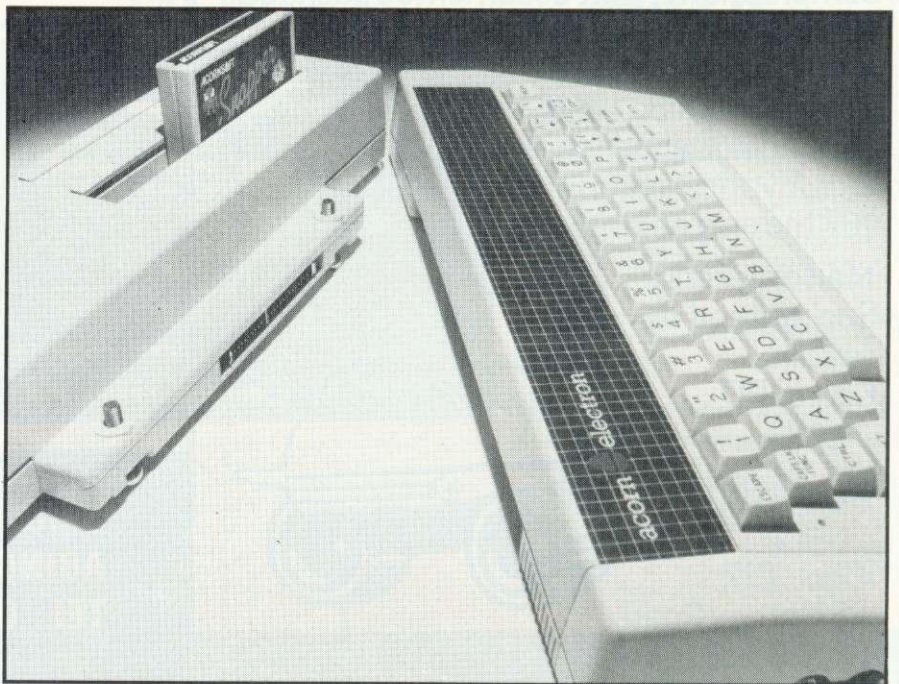

The Plus-1's edge connector is simply pushed into the back of the Electron and bolted on

# NOMINATIONS FOR BEST PRINTER AWARDS 1984

## Best Star — SHINWA CTI CP80 Matrix Printer

available for around **£199\***

- ★ 80 CPS — Bi-Directional Logic Seeking-80 Column
- ★ Friction and Adjustable Tractor Feed
- ★ Hi-Res and Block Graphics



★ NOW ON RELEASE

**SHINWA - CTI**

## Best Performer — JUKI JUKI 6100 Daisywheel

available for around **£399\***

- ★ 20 CPS — Bi-Directional Logic Seeking + 2k Buffer
- ★ 10, 12, 15 CPI + Proportional Spacing
- ★ "Drop in" Triumph Adler Daisywheel + IBM Ribbon
- ★ Supports all Wordstar features + Diablo 630 protocols



★ NOW ON RELEASE

**JUKI**

## Best Newcomer — Canon PW1080A/1156A Matrix Printers

available for around **£319\* and £399\***

- ★ 80 column — PW1080A
- ★ 156 column — PW1156A
- ★ 160 CPS — Bi-Directional Logic Seeking + 2k Buffer
- ★ Near letter quality (NLQ) printing (23 x 18 dot matrix)
- ★ Friction and Tractor Feed



★ NOW ON RELEASE

**Canon**

## Best Producer — Canon PJ1080A Colour Ink Jet Printer

available for around **£433\***

- ★ Vivid seven colour plain paper or transparency printing
- ★ 37 CPS — Quiet (50 db)
- ★ Hi-Res colour printing (640 dots)



★ NOW ON RELEASE

**Canon**

All now on general release — see them at your local dealer

Ex VAT

Best Distributor:-

**Micro Peripherals Ltd**



9 The Street, Basing, Basingstoke, Hants. RG24 0BY  
TEL: (0256) 3232 (17 lines) TELEX: 859669 MICROP G  
FAX: (0256) 61570

Call your local dealer NOW for full information on Printers or clip this coupon and we'll send you brochures and print samples.

Name ..... Position .....

Company .....

Address .....

Tel No. ....

ONE YEAR GUARANTEE

ONE YEAR GUARANTEE

ONE YEAR GUARANTEE

ONE YEAR GUARANTEE

# Small business can now stop going by the book.

For under £1,000 a small business can now equip itself with a BBC Microcomputer, a disc drive, a word processor and printer.

(All tax deductible by the way.)

Once you've parted with that money, you'll find that business has never been brisker.

Because now, there's a new series of floppy disc software specially for the smaller business.

It has been developed by Acornsoft, the software division of Acorn Computers who are the manufacturers of the BBC Micro.

For only £24.95, each disc can store volumes of vital bookwork which can be updated and amended in a fraction of the conventional time.

And there is a disc to cover most aspects of paperwork and book-keeping.

## The Invoicing package.

This program stores details of products, VAT numbers and, of course, the names and addresses of your customers. As orders come in, you simply record them. Then, when it's time to invoice, you just press a few keys and each invoice or credit note is printed automatically in seconds.



Allowing for variable terms of trading, the system calculates and prints discounts. And it should help to improve your cash flow dramatically.

## The Order Processing package.

With this program, you can confirm your customers' orders, prepare and print despatch notes and make fast analyses of individual orders or of all the orders stored on disc.



## The Accounts Receivable package.

Now, it couldn't be easier to keep your customer accounts under control.

In an instant, you can analyse debtors, produce statements, keep a check on any credit limit and calculate VAT output automatically.



Using this package in conjunction with the invoicing package, you can also keep tabs on payments received against payments outstanding.

## The Accounts Payable package.

This package will keep you fully up-to-date on how much you owe and who to. In addition, it calculates

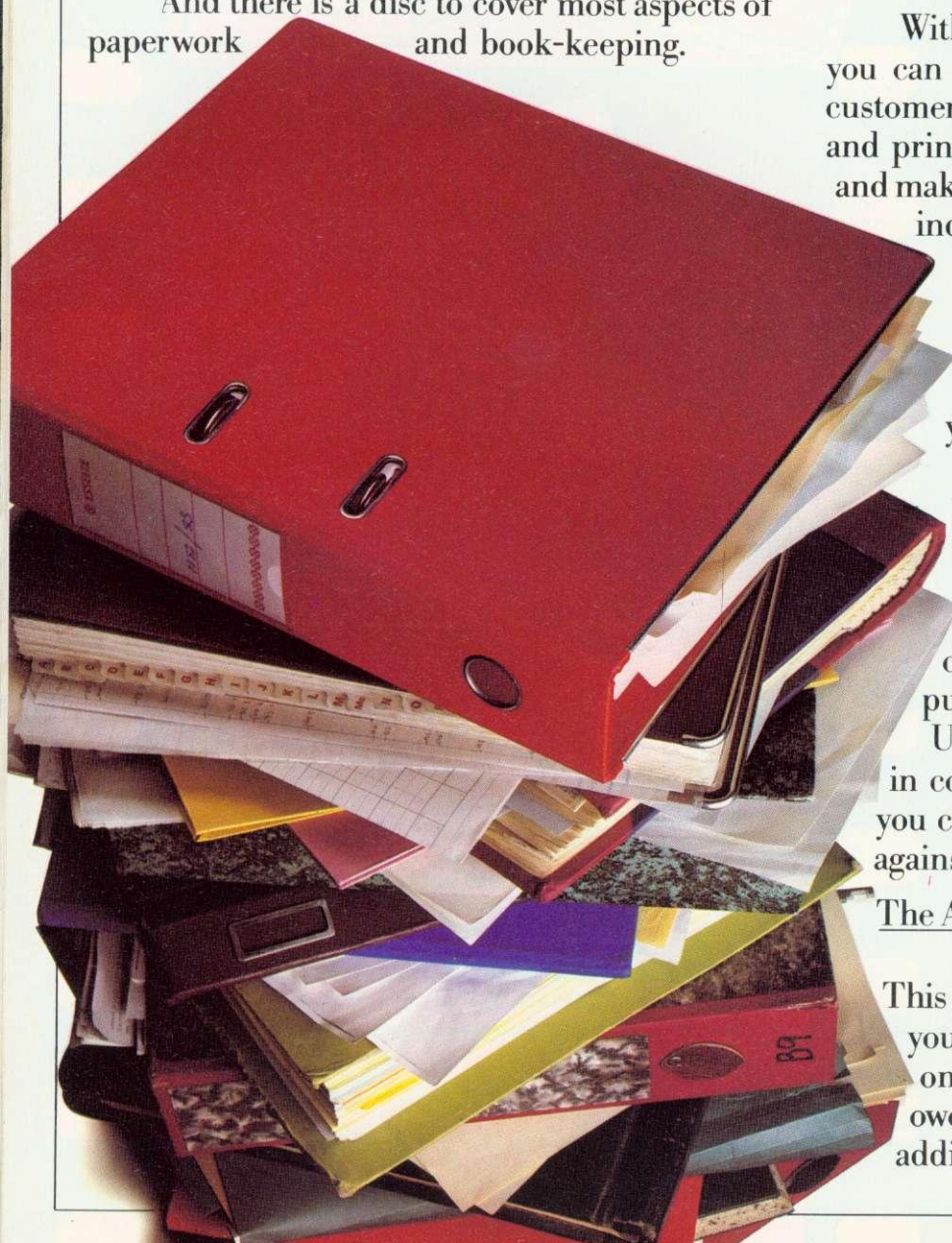

input VAT and, used with the Accounts Receivable package, produces instant VAT returns.

It also highlights settlement discounts, produces remittance advices and provides an immediate analysis of all creditors.

### The Stock Control package.

Touch a few keys and you have instant access to stock status and automatic analysis by quantity and value.

Consequently, it's easy for you to maintain correct stocking levels, having an early warning of out-of-stock situations or the likelihood of over-stocking.



Average value of the business they do with you, or whether they are good or bad payers.

Then, when you are doing a mailing, you simply choose the group or groups of customers you want.

At £24.95 each, these packages could be priceless.

Each package comes with clear instructions on how to get the program running so that you can devote much more of your time to more profitable activities.

If you're a credit card holder, you can order any or all of the packages by ringing: 01-200 0200 anytime. Or 0933 79300 during office hours.

(By ringing the same number, you can get the address of your nearest stockist, or full details of the BBC Microcomputer system if you don't already have one.)

Alternatively, you can order the packages by sending the order form below to: Acornsoft, c/o Vector Marketing, Denington Estate, Wellingborough, Northants NN8 2RL. Please allow 28 days for delivery.

 Credit card holders, phone 01-200 0200, anytime. Or 0933 79300, during office hours.

### The Purchasing package.

All your suppliers' names and addresses go onto the disc. Then they can be retrieved instantly for preparing and printing orders.

All order data can be recalled in seconds, allowing you to check on orders, and suppliers' invoices and to record all deliveries.



### The Mailing package.

Instead of the shotgun method of sending mailshots, this package enables you to refine each mailing down to the customers who are most likely to respond.

It gives you a rapidly accessible mailing file of your customers, according to any criterion you choose. Size of company, for instance, or type of business.



To: Acornsoft, c/o Vector Marketing, Denington Estate, Wellingborough, Northants NN8 2RL.  
Please send me the following business software packages at £24.95 each.

PROGRAM	QUANTITY	TOTAL	(Code Acornsoft use only.)
Invoicing			SNB 08
Order Processing			SNB 12
Accounts Receivable			SNB 10
Accounts Payable			SNB 13
Stock Control			SNB 11
Purchasing			SNB 14
Mailing			SNB 09
TOTAL			

I enclose PO/cheque payable to Acornsoft Ltd. Or charge my credit card.

Card Number \_\_\_\_\_  
Amex/Diners/Visa/Access (Delete)

Please send me details of the BBC Microcomputer System

Name \_\_\_\_\_

Address \_\_\_\_\_

Postcode \_\_\_\_\_

Signature \_\_\_\_\_

Registered No. 1524763

VAT No. 215 8123 85

AC.4.

# ACORNSOFT

# OUR B.B.C./ELECTRON GAMES ARE'NT JUST GOOD TO LOOK AT



## NIFTY LIFTY



**NIFTY LIFTY**  
BBC MODEL B — VB-09-32  
ELECTRON — VE-04-32

Your prime objective is to rush through a department store collecting as many goodies as you can without getting squashed flat by seemingly unending and uninterrupted lifts. The only controls involved are left and right and the only skills needed are lightning fast reactions and an over developed spatial co-ordinating ability.

£5 95

## PENGI

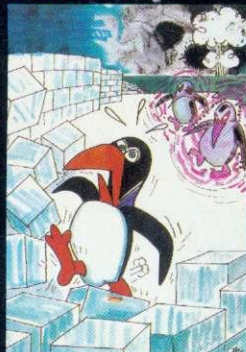

**PENGI**  
BBC A/B — 32K RAM OS1-2  
VB-04-32

Enormously absorbing and highly challenging, a great favourite for any age of player.

£5 95

## DARE DEVIL DENIS

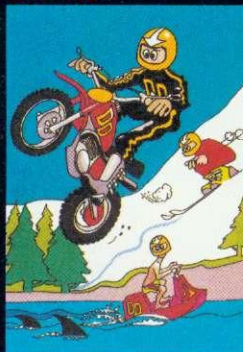

**DARE DEVIL DENIS**  
BBC MODEL B — VB-03-  
ELECTRON — VE-02-32

The game comprises three scenarios on land, sea and snow with six different skill levels from Novice to Ace. The object of the game is to take Denis through each different scenario doing various stunts and combatting the hazards. For each hazard successfully overcome the day's wages are incremented. The game automatically gets harder as you get better, and as you will find when you play it, it is extremely challenging.

£7 95

## DEMOLATOR



**DEMOLATOR**  
BBC MODEL B, OS1-2  
VB-10-32

Demolator is a great game for any age but requires a marked degree of skill as you control movement left and right and up and down and also the fire control system.

A marvellous game for anyone with 3 arms or more.

£6.95

## SNOOKER



**SNOOKER**  
BBC MODEL B — VB-01-32  
ELECTRON — VE-01-32

The game is currently at No.5 in the PCN charts, no mean achievement as it was launched in September of 1983.

The game requires a high degree of skill for proper enjoyment, and it is possible to have a good game with an opponent which would depend purely upon your skill and not luck. However the game can be readily enjoyed from the start because of the extensive instructions and options.

£8 95

# Visions

THE NAME IN VIDEO GAMES

AVAILABLE FROM ALL GOOD SOFTWARE STORES  
VISIONS (SOFTWARE) FACTORY LIMITED 1 FELGATE MEWS STUDLAND STREET LONDON W6

SEND S.A.E. (A4)  
FOR FULL COLOUR CATALOGUE





# Electronequip

(Authorised BBC Dealer, and service centre)

## SOFTWARE

(A few examples from our range of 1,000+ titles)

	Ex. VAT	Inc. VAT
BCAFCNIC	6 87	7 90
BCAKMUNG	8 65	9 95
BCALBUGB	6 91	7 95
BCALLUNA	6 91	7 95
BCAMCALC	6 04	6 95
BCAS100P	10 00	11 50
BCASAVIA	13 00	14 95
BCASJCB	8 65	9 95
BCBETIM1	7 80	8 97
BCBSWHIT	10 00	11 50
BCFBSTFO	6 04	6 95
BCGACHEE	11 26	12 95
BCGEBEEB	17 35	19 95
BCGEBEEP	17 35	19 95
BCGGNUMB	8 65	9 95
BCGHTALP	11 26	12 95
BCGRORBI	8 65	9 95
BCHIFIRE	6 52	7 50
BCHOBEGA	14 24	14 95
BCHSPENG	7 75	8 91
BCIBOATI	11 00	12 65
BCIJAATLA	5 65	6 50
BCJOYSTI	5 95	6 84
BCKAGALA	8 25	9 49
BCKAPINB	8 25	9 49
BCKDPASS	9 50	9 95
BCKDFREB	8 65	9 78
BCKOGERA	8 65	9 95
BCCLSNOW	8 61	9 90
BCMHOBBS	13 00	14 95
BCMRGRST	6 91	7 95
BCMSFIRS	7 78	8 95
BCPPGHOU	6 91	7 95
BCPPINTE	7 78	8 95
BCPPMAZE	5 17	5 95
BCPPSPAC	6 04	6 95
BCPSVUCA	13 00	14 95
BCQSBEEB	13 00	14 95
BCQSMUSI	13 00	14 95
BCRHSKIS	7 78	8 95
BCSHGBLT	6 04	6 95
BCSIATTA	6 91	7 95
BCSIEAGL	6 91	7 95
BCSIGUNS	6 91	7 95
BCSMDIS	6 91	7 95
BCSSCENT	6 91	7 95
BCSSCRAZ	6 91	7 95
BCSTDRAU	5 00	5 75
BCSUGRAS	8 65	9 95
BCSUWORD	8 65	9 95
BCVMDLST	5 17	5 95
BDASACCP	21 70	24 95
BDDBMAST	16 50	18 98
BDDBVIEW	16 50	18 98
BDCLKEY	11 26	12 95
BDCLEPLF	10 43	11 99
BDICYFAYR	43 43	49 94
BDEEDWORD	51 95	59 74
BDELUT18	8 65	9 95
BDELVIF4	12 00	13 80
BDELVIP8	12 00	13 80
BDHSLETB	7 82	8 99
BDVMCEL8	7 79	8 95

## PRINTERS

	Ex. VAT	Inc. VAT
Printer Interfaces		
PIEPPB08	75 00	86 25
PIEPPB16	85 00	97 75
PIEPPB32	105 00	120 75
PIEPPB64	145 00	166 75
Printer		
PTBHR15	399 00	458 85
PTCP80	199 00	228 85
PTDS2000	299 00	343 85
PTFX100	515 00	592 25
PTFX80	399 00	458 85
PTINTEGE	489 00	562 35
PTJ6100	390 00	448 50
PTJP101	299 00	343 85
PTKP810	299 00	343 85
PTKP910	399 00	458 85
PTMCP40	113 00	129 95
PTMX100	445 00	511 75
PTMX80	299 00	343 85
PTRX100	410 00	471 50
PTRX80	259 00	297 85
PTRX80FT	279 00	320 85
PTSD10	345 00	396 75
PTSDP510	289 00	332 35
PTSDP515	399 00	458 85
PTSGE10X	219 00	251 85
PTTI040	1285 00	1477 75
PTTI055	1675 00	1926 25
PTTI5002	599 00	688 85
PTTCOLR	1550 00	1782 50

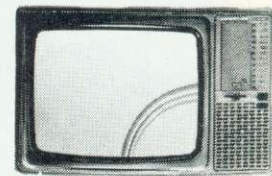

## NORDMENDE

14" TV/Monitor £213.00 + VAT

Monitors	Ex. VAT	Inc. VAT
MNB12E	99 00	113
MNCE370A	169 00	194
MNK12A	113 00	129
MNK12G	99 00	113
MNKVIS1	199 00	228
MNKVIS2	285 00	327
MNKVIS3	399 00	458
MNKX1201	99 00	113
MNKX1202	113 00	129
MNKX1203	113 00	129
MNM1431	199 00	228
MNM1431A	225 00	258
MNM1431Z	225 00	258
MNM1441	440 00	506
MNM1451	299 00	343
MNN1534	213 00	244
MNN3534	234 00	269
MNN3536	310 00	356
MNN4430	417 00	479
MNN4432	458 00	526
MNN4437	512 00	588
MNSM12M	79 00	90



Disc Drives	Ex. VAT	Inc. VAT
DDAND01	217 50	250
DDAND02	607 83	699
DDCASE	8 60	7
DDCD200	305 00	350
DDCD400	386 00	443
DDCD400S	469 00	539
DDCD800	431 00	495
DDCD800S	499 00	573
DDCDX200	298 00	342
DDCDX400	386 00	443
DDCDX800	430 00	494
DDCS100	169 00	194
DDCS200	209 00	240
DDCS400	233 00	267
DDCSX100	149 00	171
DDCSX200	193 00	221
DDCSX400	215 00	247

## TORCH COMPUTERS

Perfectly Made in Britain

Torch Computers	Ex. VAT	Inc. VAT
TC301	1430 00	1663 00
TC303	1449 00	1666 30
TC350	2250 00	2587 50
TC353	2455 00	2823 25
TC68000	3550 00	4082 50
TC68020	5900 00	6785 00
TC725	5650 00	6497 50
TC725U	6050 00	6957 50
TCNET	85 00	97 75
TCF500	2950 00	3392 50
TCF5500	3150 00	3622 50
TCCH520	1449 00	1666 30
TCCHR68K	2495 00	2868 25
TCCHP280	2295 00	2632 25
TCCHS20	5650 00	6497 50
TCMC240	575 00	661 75
TCUNICOR	2895 00	3329 25
TCZ80SP	375 00	431 25
TDZ80DP	695 00	799 25



# Electronequip

36-38 West Street, Fareham, Hants (0329) 230670

Kings Lynn Branch  
Tel: 0553 3782



# Electronequip

(Authorised BBC Dealer, and service centre)

**NEW EXTENDED  
TEL. ORDER SERVICE**

**6 sales lines manned to  
10.00pm Monday to Friday**

**\* SPECIAL OFFERS  
Mail order only**

**\* EPSON**

**RX-80FT** £245.52 + VAT

**FX-80** £365.09 + VAT

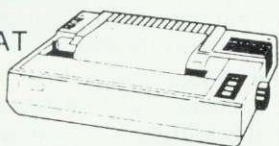

Printer price includes cable for BBC and screen dump rom is available for £7.50

**2 FREE ACORNSOFT  
GAMES WITH EVERY  
BBC SOLD \***

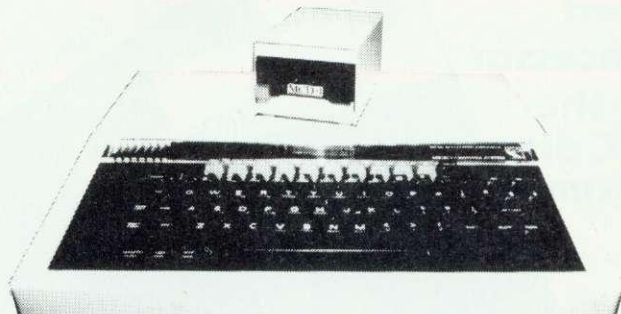

Electronequip is an authorised Acorn service centre and has been an Acorn dealer since the introduction of the Atom. Our demonstration facilities include 20 station Econet and Torchnet systems.

Ref.	BBC Micros	Ex VAT	Inc VAT
ANB01	BBC Model B Micro Computer	348.26	399.00
ANB02	BBC Model B with Econet Interface	389.14	446.00
ANB03	BBC Model B with Disc Interface	426.59	489.00
ANB04	BBC Model B with Disc & Econet Interface	467.45	536.00

**VOLTMACE DELTA 14B**

**\*10% off listed prices**



SVOLT 14	Voltmace Delta 14B Joysticks	13.00	14.95
SVOLTAD	Voltmace 14B/1 Adaptor Box	12.91	14.85

**3" Micro Disc £129.95  
(inc. VAT)**

**Disc Interface &  
Drive  
£198.95 (inc. VAT)**



Micro Disc Drive for the BBC Micro

The Micro disc drive offers a method of low cost quick access to programs. The drive is essentially a small version of a 5¼" disc drive and offers similar features to the larger drive. The data is stored on a 3" disc, this is enclosed in a protective hard plastic cassette which features a write protect switch. The micro drive requires the standard Acorn disc interface, but a new disc filing system rom. Acorn DFS may be exchanged for the micro DFS for £12.00. The new micro disc filing system can read and write to Acorn DFS discs. Thus if a 5¼ inch and a micro floppy were connected on the same cable files could be transferred between them.  
**Capacity: 80.64 K bytes Transfer Rate: 125k bit/s.**

## BRANCHES

**FAREHAM: 59 WEST STREET (0329) 230670**  
**KINGS LYNN: 17 TENNYSON AVE. (0553) 3782**  
**MAIL ORDER: 36-38 WEST STREET**  
**FAREHAM, HANTS. (0329) 230670**



# Electronequip

36-38 West Street, Fareham, Hants (0329) 230670

**Kings Lynn Branch  
Tel: 0553 3782**



# A little bit of magic from MERLIN COMPUTER PRODUCTS

AN UNBEATABLE COMBINATION! A WORD PROCESSOR  
AND DATABASE WHICH CAN BE INTEGRATED.

## MERLIN SCRIBE

The first professional  
word  
processor  
for the  
BBC disc  
system.

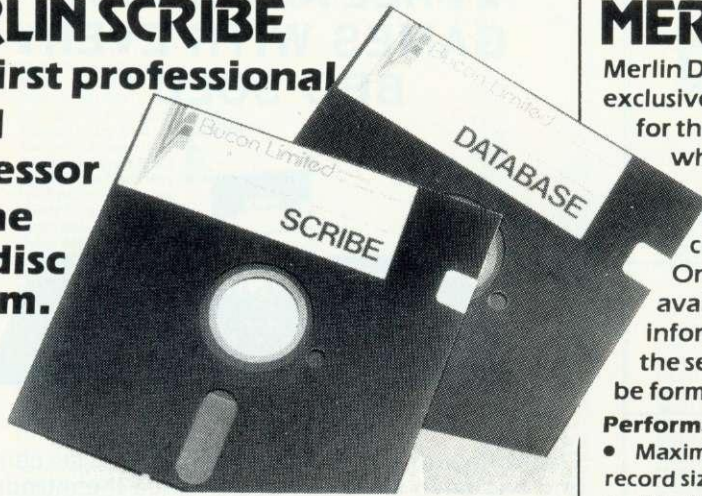

### Among the many features available are:

- Create up to 255 pages in a single document.
- Screen user selectable 40 or 80 column with choice of background and text colours.
- Insert text at any page on the document whether currently in memory or not.
- Powerful editing commands:  
Move, copy and delete with affected text displayed in reverse video. Will move or copy within a page or to any other page in the document.
- Word search and replace — item by item or globally throughout the document.
- "Go to page" — next and previous using up and down cursor keys or go directly to page numbers
- On screen underlining.
- Format line controls document width and allows setting of right and left margins.
- Tabs set on format line as required.
- Automatic centre and decimal tab.
- Text reformatting.
- Split page and dynamic page break display.
- Word count and display of cursor position by column & line number.
- Will use disc surfaces 0 to 3 as allowed by the BBC system.
- All disc filing operations menu driven, eg. re-name, copy, delete document, compact and catalogue disc, etc. No knowledge of the disc system required.
- Exec document — allows conversion of BASIC programs for editing by word processor and then re-conversion back to either text or program files.
- File merge — one or more documents or other text files may be merged in sequence from any disc drive between 0 and 3.
- Automatic page numbering with page number insertion at any point on the page.
- Headers and footers.
- Total facility print module including selection of serial or parallel output, global printer control codes, page numbering offset, print from page to page, repeat print, etc.
- Selection of up to nine user definable keys for insertion of printer control codes into text, with up to five codes allocated to each key.
- Control number of page display lines for scroll speed increase.

The program comes attractively packaged in a simulated leather grain wallet which contains the manual, disc, chip & function key legend strip.

## MERLIN DATABASE

Merlin Database is a database system designed exclusively for the BBC disc based computer. It provides for the structural input of text and numerical data which is stored permanently as a record on the computer. A group of records constitutes a database. Any number of databases may be created using Merlin Database.

Once created there are sophisticated facilities available for searching, selecting and drawing off information from the database by means of defining the search characteristics. This information can then be formatted for producing printed reports, lists etc.

### Performance

- Maximum records per database 4000
- Maximum record size 1800 characters
- Maximum no. of fields 32
- Maximum no. of characters for any single field 900
- Find any record in 2 seconds via key field access
- Search every character in a 100 kb database in 29 secs

### Field Types

- Numeric — up to 9 digits
- Date
- Sub fields for economic disc usage i.e. specify average & maximum field size

### Data Search

- Search results directory held with database on disc
- Data can be passed to mail merge and report writer
- 16 level conditional search
- Search conditions include 'not', '>', '<', '='.
- Wild card
- Database automatically sorted by key field
- Database can be set to re-sort to any alternative set of key fields

### Report Writing

- Database will integrate with Merlin Scribe word processor
- Format printer output with simple forms editor
- High powered forms layout & editing using Scribe (alls. rt. justify)
- Arithmetic calculations & accumulators
- Conditional report writing
- Semi programming facility for forms & report generation

### Other Facilities

- Mail merge using Scribe
- Conditional mail merge
- Automatic reformatting of lines
- Capable of conditional transfer of information between databases.

Database comes in chip with manual, simple fitting instructions & systems disc. Also planned is the production of Database integrated with the Merlin Scribe word processor in a single chip although the database is designed to integrate easily with Scribe in a separate chip.

**MERLIN DATABASE £49.00**  
**MERLIN SCRIBE £59.95**  
**MERLIN SCRIBE/DATABASE £95.00**

Prices include VAT. Price and specification subject to change without prior notice.

Credit card orders accepted. Special discounts for educational establishments and dealers.

**MERLIN COMPUTER PRODUCTS (BUCON LTD)**  
**35/36 SINGLETON STREET, SWANSEA SA1 3QN**  
**Tel: (0792) 467980 (3 lines)**



# FUTURE CONNECTIONS

The new ideas in contact-by-computer

**C**OMMUNICATIONS for home computer users by satellite, cable and cellular radio is not just a distant possibility: it's happening now. On the following pages Joe Telford and Paul Curtis and Elliot Hessey look at the finer details of connecting personal computers to the public switched telephone network (PSTN, as it is known). The best is yet to come however, as faster, cheaper and more widely available methods of communication come on stream. Some manufacturers such as Torch and Commodore have taken the initiative and provided PSTN-based services for their customers already. Torch's Torch-Mail allows users of its business-oriented computers to exchange messages and software automatically, even when the machines are left unattended. This allows the computers to communicate when calls are cheap and with minimal effect on other telephone users.

One of the major new ideas in computer communications is distributed systems: the splitting of a large or complex task among a number of computers. This is logical for humans; only a moment's reflection brings examples such as the typing pool to mind. However, in the past computers have tended to be too expensive for all but the richest users to be able to exploit distributed computing. The advent of the microprocessor has changed all this.

Where a computer needs to exchange data with another distant computer, the PSTN provides a simple enough method. By merely adding a modem to most computers it is possible to send and receive data this way. Systems such as Micronet and bulletin boards are now very popular as a way for micro users to swap programs, hints and gossip. As the ways that we connect computers together improve, so we can expect to see more sophisticated uses of computers. It would be nice if you could leave your computer a list of things you want to know when you go to bed, and wake up the following morning to find your questions answered. This is what the Torch machines can do now.

A disadvantage of today's dial-up computers is that if the central machine breaks down all users suffer. To overcome this problem we can split the information that we want to store among a number of machines. This obviously complicates retrieving the information, but it means that one computer failure will not necessarily affect so many users. The second useful effect of distributed computing is the sharing of expensive resources such as hard discs or high-quality printers. Local area networks such as Econet permit

sharing of this kind on the small scale, but obviously we cannot wire the whole country into an Econet.

The PSTN is an obvious medium to use when introducing a distributed system. It is not really effective as a medium for high-speed data though, so further improvements are needed. Two new developments seem likely to be of help.

First, the introduction of cable TV will provide many homes with a very efficient medium right into the front room. The most important difference between cable and ordinary broadcast TV is that cable users can answer back. Initially, cable companies will use this facility to let viewers vote on programs and answer quizzes from their armchairs. It is also an almost perfect way

of sending computer data, and a fast one at that.

The other important new service is the introduction of cellular radio. This technique lets telephone users move around wherever they choose by using a hand-held or car telephone. The cellular radio control system will then route calls to them automatically. To begin with it will provide only a voice service just like the PSTN, but the operating companies are looking hard at the possibility of sending computer data too. Connecting telephone and television all around the world will link every subscriber with common data channels. The possibilities are mind-boggling – it's really just a question of how many users are willing to exercise their wallets.

**T**HE TV production team working on the BBC's Computer Literacy Project has been using the telephone system to send data backwards and forwards in their work for some time. Robin Mudge, director of the recent *Computers in Control* series, and Clive Williamson, his assistant, are old hands at electronic mail and its uses.

For Robin, the worst part of being an assistant producer used to be script writing; not thinking of the ideas but the act of setting pen to paper. Each programme script has to be re-written many times as ideas develop, a thought he found depressing at best. However, Robin soon discovered wordprocessing through *Wordwise* and *View* on the BBC micro, and found them real life-savers. He could really enjoy writing, but quickly discovered limitations. Time spent out of the office researching stories meant no wordprocessor, as the BBC micro is not exactly ideal for carrying around. But the advent of portable micros, and British Telecom's electronic mail service called Gold, meant he could write on location and send the text back to base, where it could be worked on by a BBC micro.

The first useful portable computer was the Epson HX20. This was quickly followed by the Tandy model 100 and the NEC PC8201A and more recently the Sharp PC5000. Both the Tandy and NEC have large liquid crystal displays showing 40 columns by eight lines and come with limited wordprocessing and communications software. The latter enables the portable micro to communicate with another computer over the phone lines via an acoustic coupler. The coupler has two rubber cups that fit tightly over the mouth- and earpieces of an ordinary telephone handset, insulating it from sounds other than those produced by a small loudspeaker and microphone which transmit and receive the audible tones used to carry data. The Sharp PC5000 is one of the latest portables and although heavier than other lap computers, it has all the facilities of a 16-bit desk-top machine with an 80 column by eight line LCD display and runs application software from magnetic bubble cartridges, including a powerful wordprocessor and the essential communications software.

Robin prepares text on the portable and sends it over the phone into BT's electronic mail system. This can be done anywhere in the world as long as a telephone is available. At any time the BBC model B back at base can be connected to the electronic mail service and text loaded from it into a *View* or *Wordwise* file. Of course the system works in both directions, so messages can be sent to anybody. All

# REMOTE

Paul Curtis and Elliot Hessey monitor

the members of the BBC's Computer Literacy team have an electronic mailbox and so can communicate with each other at any time. Robin says the

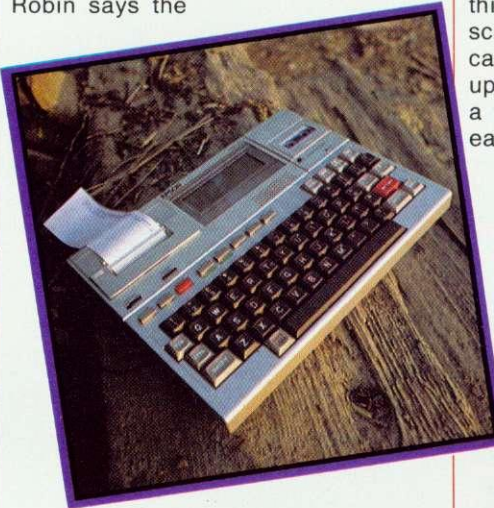

system offers a great deal of flexibility. 'First, it gives users a great deal of freedom; you can move around with peace of mind knowing you are in contact with the office at all times. Second, it offers enormous flexibility in the use of different machines and software within the same group. As long as the micros can all talk to the electronic mail computer, text from any number of different machines and wordprocessing packages can be freely interchanged and merged. Of course it does have its drawbacks - you can't hide away! Gold can even tell the sender if you have read your messages. Also, I like my portable so much that it's difficult to stay in the office when the sun shines.'

In the comfort of his home in London, Clive Williamson uses a BBC micro to get at the information on Telecom Gold. His model B is fitted with a Computer Concepts *Communicator* ROM, and a modem. Both *Communicator* and modem can be set up to operate with a range of baud rates, so the system can work with either the 1200/75 or 300/300 standards available on Telecom Gold.

'To keep phone bills down,' Clive confides, 'I use the 1200/75 baud rate when I'm expecting to receive Robin's text, and 300/300 to send it back in its augmented form. A long file would take ages to send at 75 baud, which only

transmits at about seven characters per second. *Communicator's* parameters can be changed easily using a function-key driven menu to alter things like send and receive rates, screen display and telecommunications protocols. Once it has been set up, all the parameters can be saved as a file on disc or tape, and loaded in each time you switch on!'

The modem's default conditions are

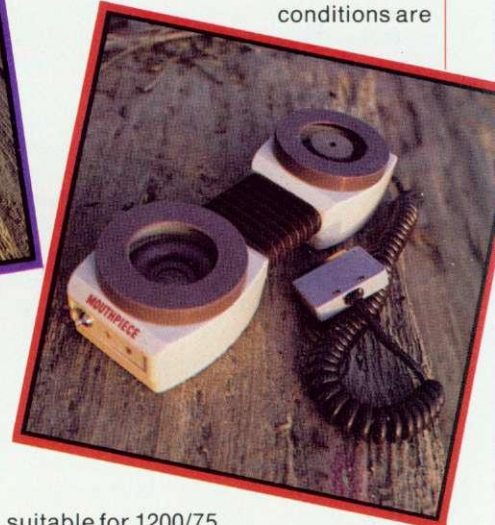

suitable for 1200/75 operation on Telecom Gold, so Clive has to load in a file he has called '300/300' to work at the alternate rate. He also has to change some settings on the front of the modem to match the output from the BBC micro's RS423 serial interface.

Having sorted out his equipment, Clive dials the Telecom Gold computer, and as soon as he hears the carrier tone, switches the modem on line and replaces the telephone handset. The modem then maintains the connection, and Clive can log on to the system using his own account number and password. The modem gives a very reliable link to the BT computer because it makes a direct connection with the telephone line, but for this reason it is essential to obtain BT approval to use it.

The text file from Telecom Gold is in the form of a stream of ASCII characters and *Communicator* turns the BBC micro into a 'terminal' to receive the file, and display it on the screen. The text can also be printed out; or

# POSSIBILITIES

an application for electronic mail that involves strict deadlines

'spooled' to disc using the function keys. Once Clive has stored the file on disc, he can send notes to other users on the system before signing off to begin work on Robin's text. A spooled file can be read back into either *Wordwise* or *View*. Clive uses *View* to make his additions to the text, because of its extra functions like search, change or optional replace; and its 80 character display. When the additions have been made, he saves the work by opening a new file with \*SPOOL, and then uses *View*'s screen command to save another ASCII file on disc with a new file-name.

'The new file could then be sent straight back to Robin on Telecom Gold

for him to read and revise', says Clive, 'but I usually tidy it up first by running it through *Wordwise*. That way I can remove the unwanted carriage returns and the *View* command page heading that always creep into the file before you can use \*SPOOL to close it.'

It seems that *Wordwise* provides the easiest medium for handling files from Telecom Gold, because its menu has a trouble-free option to read files in and spool them out again without the introduction of any extraneous characters. 'Using both *View* and *Wordwise* is a luxury,' explains Clive, 'and *Wordwise* alone would be quite sufficient!' With the new file on disc, Clive re-dials the Telecom Gold number (for the faster 300/300 rate this time) and logs on again to send the revised work to Robin's account number using \*EXEC through another of *Communicator*'s options.

has obvious implications for small-business users, particularly those with 'reps' on the road. Reports and messages can easily be relayed over the system, irrespective of time differences between countries or people not being available at a particular time. Each user simply logs on to see what messages are waiting, and file a report if required. The cost of joining Telecom Gold is currently quite high (around £100 for the first month), but once some user groups have been set up (in the same way that Micronet 800 is available for microcomputer owners on Prestel) the price to the individual could drop. Then we would see the system in much wider use, and once that happens, electronic mail will certainly be here to stay.

## SENDATA 700B ACOUSTIC COUPLER

THE Sendata 700B is a compact battery operated acoustic coupler for use with any computer having an RS232 interface. It comes in one of two preset baud rates, 300 send and 300 receive for normal data transmission and 1200 send and 75 receive for use with Prestel-type services. The body of the coupler is made of two

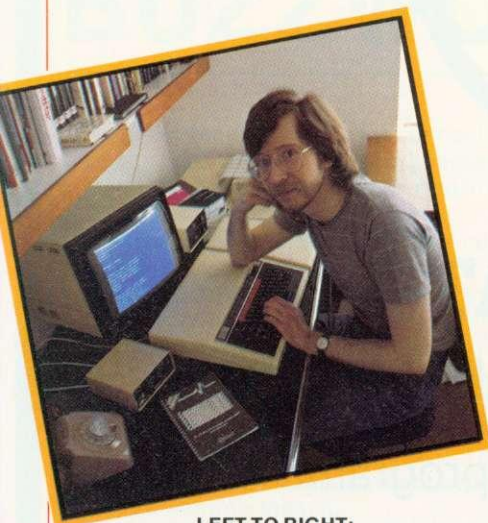

LEFT TO RIGHT:

Epson HX20: a 16k, eight-bit portable with built-in printer and microcassette recorder running a communications software package from Transam in ROM. This package enables the little printer to print 80 character pages sideways! Optional extras include floppy disc and TV display. Starting price £480

Sendata 700B acoustic coupler. Supplied with rechargeable nickel-cadmium batteries and charger. Approx £250

Clive Williamson with his BBC model B and modem running Computer Concepts's *Communicator* ROM

Robin Mudge with his Sharp PC5000 portable computer on Bank Holiday location!

Using an acoustic coupler, the portable micro can talk to the British Telecom electronic mail computer anywhere

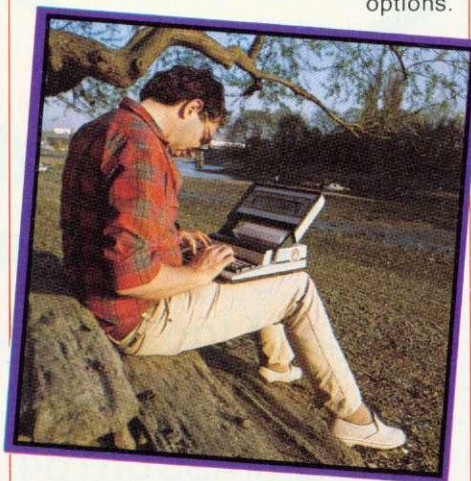

The receiving and sending procedure can be repeated as often as necessary to finish the work, with Robin picking up the text whenever he happens to be near a phone. Once finalised, the file can be printed out in the office and used as required. Clive recently wrote a piece for *Acorn User*, and was able to beat the post by sending it to the Editor's Telecom Gold account number, where it could be retrieved for immediate editing on a wordprocessor.

This approach to using telecommunications may seem a little ambitious for home users of the BBC micro, but it

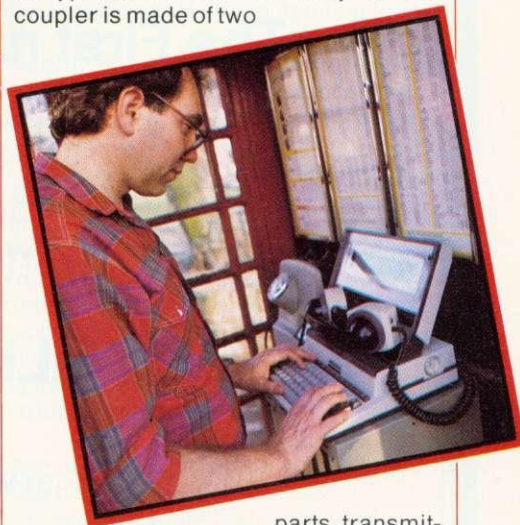

parts, transmitter and receiver, which are joined by a flexible concertina-type section. This enables the coupler to fit a wide range of different handsets. It is clearly marked to show which way the telephone receiver should be fitted. The snug-fitting rubber cups insulate the

# **CHESHIRE CAT** **EDUCATIONAL SERIES** from **AMPALSOFT**

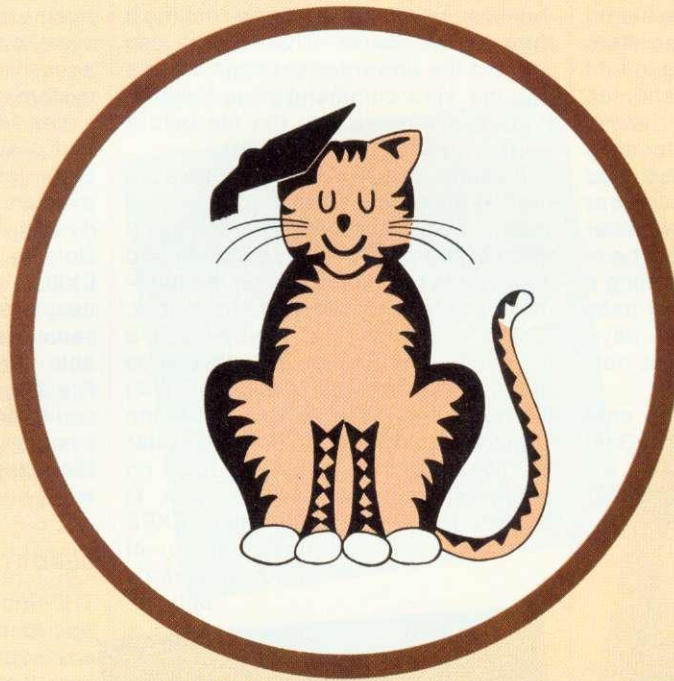



## **CHESHIRE CAT**

**The First name in Educational Software.**

An exciting range of top quality programs  
Available for BBC, Electron, Dragon 64, Dragon 32.  
Available shortly for Commodore 64, Spectrum 48K.

**RETAILER ENQUIRIES WELCOME**

Ampal Computer Services Ltd.,  
31 Woodbridge Road, Darby Green, Blackwater,  
Camberley, Surrey.  
Tel: (0252) 876677.

Available from selected branches  
 Boots, W. H. Smith and Dragon Data Ltd  
 and other good computer stores



phone from outside noises that could interfere with data transmissions. Rechargeable batteries are contained within it and an external recharging unit is supplied. There is a small switch on the transmitter section that changes the operating mode from originate to answer. Using two of these couplers, computers can communicate directly, one originating data and the other answering it. Cost about £250.

## MINOR MIRACLES WS2000

THE Minor Miracles WS2000 is one representative from the 'new wave' of low-cost modems currently appearing, and offers more facilities than most. At the moment, however, it awaits British Telecom approval.

## COMMUNICATOR

Computer Concepts' *Communicator* program is supplied as a 16k plug-in EPROM, and is ideal for use with modems. In its basic configuration it

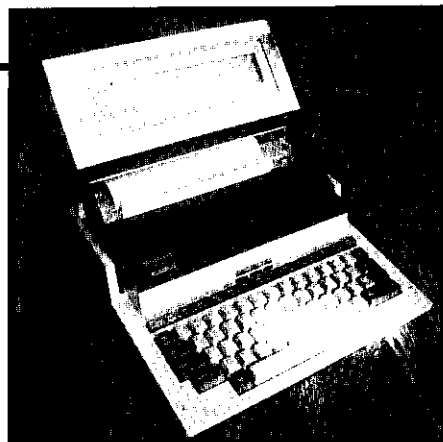

**Sharp PC5000: this 128k, 16-bit machine has an 80-character by eight-line display and optional thermal printer running Superwriter software under MS-DOS. Options include 128k bubble memory packs, 64k expansion RAM modules, floppy disc drives, full range of MS-DOS software. Starting price £1195**

can be used to communicate with Telecom Gold at the 1200/75 rate, but its parameters may be changed to accommodate many other modes of operation. It is also designed to turn the BBC

micro into a mini or mainframe terminal, and can pretend to be a DEC VT100 or VT52 terminal. This well-designed ROM generates a series of clear menus to help set up the parameters, and these can be saved as a file and loaded in again to speed up future use. It is also possible to edit the Beeb's user-definable function keys to generate strings, such as ID codes for logging on to particular computers.

*Communicator* works with the second processor, but current versions will not reset when the micro's BREAK key is pressed. It works perfectly with an unexpanded BBC micro, however, and normally gives a pleasant white-on-blue 80 column display. *Communicator* costs £69.

Computer Concepts also markets a language ROM for the BBC micro called *Termi* which costs considerably less at £33 and offers many of the facilities of *Communicator*, but without the frills. *Termi* is on an 8k EPROM and will work with or without the second processor.

# BUZZWORDS

A glossary of terms used in computerised communications

**Acoustic coupler** Device for connecting a computer to the phone lines via the telephone handset.

**Baud rate** Serial transmission rate in bits per second.

**BT** British Telecom.

**Carrier** A high-pitched tone which 'carries' the transmitted signal.

**Carrier detect** An output line from the modem to the computer which indicates a carrier is present.

**Control register** Information written to this register commands the ACIA to perform certain tasks.

**Dumb terminal** A terminal which can only transmit and receive. Information cannot be passed to and from printer and discs.

**Electronic mail** Information sent between people using entirely electronic means.

**Even parity** Where the total of bits set to the binary value 1 in a byte plus the parity bit will be an even number.

**Full duplex** Mode of operation of a communications system where the host computer re-transmits every character it receives. This verifies the reception of the characters.

**Half duplex** Mode of operation where the terminal prints each character as it is sent. Half-duplex terminals on full-duplex systems give ddoouublliee tteexxtt.

**Hacker** American term for hobbyist computer user (recently associated with electronic communications in the movie *War Games*)

**Hardcopy** Printout from a computer or generally print on paper.

**Host** An answering (usually large) computer system which you can use with a terminal.

**Log off** Leave a host system.

**Log on** Connect with a host system.

**Mark** The time during which a bit is set to 1.

**Modem** From the word *modulator-demodulator*. A device which connects a computer directly to the phone lines. Needs BT approval.

**Odd parity** Where the total of bits set to 1 in a byte of data plus the parity bit will be an odd number.

**Off-line** When a printer or terminal is disconnected from a host computer it is said to be 'off-line'.

**On-line** When a printer or terminal is connected to a host computer it is said to be 'on-line'.

**Parity** To check the integrity of data some systems include an extra bit, called a parity bit in each word transmitted. From this bit it is possible to tell whether the word has been transmitted correctly.

**Register (ACIA)** An area of memory (1 byte) shared between computer and ACIA.

**Ring detect** An output line from a modem to a computer which indicates that the phone is ringing. (NB in most auto-answer modems, the phone bell does not sound).

**Smart terminal** A terminal which can cope with accesses to its own disc and printer. It can normally send and receive whole files which can be stored or printed out.

**Space** The time during which a bit is set to 0.

**Start bit** The first bit transmitted serially. It indicates the start of a word.

**Status register** Register in the ACIA which contains the present state of the ACIA hardware.

**Stop bit/s** The last bit or two bits transmitted in the word.

**Terminal** A keyboard and screen or a BBC micro with RS423 software capable of communicating with a (large/r) computer.

**Word** Group of bits which make up the serial transmission parameters for any character.

Joe Telford's primer on turning the Beeb into a terminal: how the systems work, hardware, software, and a comms simulator



so one might find accounts for firms like Acorn, BBC, MEP, Amstrad and others.

## Equipment

Contacting any of the services detailed above requires a certain amount of equipment. The simplest needs are:

- BBC micro (model B) + monitor.
- Modem or acoustic coupler.
- Terminal software.
- Telephone.

The micro needs no further explanation, and the telephone is an obvious requirement.

Software must reflect your needs, and although this article provides some dumb terminal software, users might find purpose-built 'smart packages' (eg *Termi* or *Communicator* from Computer Concepts) more useful. 'Smart' terminal software will allow the use of discs and printers, enabling wordprocessed files to be sent and received via the phone lines.

The modem or acoustic coupler is worth considering carefully. An acoustic coupler can be attached to a telephone simply by pressing the telephone handset into the coupler. Beware, however, of the older couplers and the newer slimline phones - they just don't fit together. An acoustic coupler costs £50 upwards. The main disadvantage is that the coupler is often sensitive to vibration, line interference and external noise. (One cheap coupler I used would function properly only when laid on a sponge rubber pad, and covered with towels!)

Modems are more reliable, but have their own problems. First, they connect directly to the phone line, and therefore *must* be approved by BT. Second the modem plugs into the new-style BT wall sockets, and you may need to have these fitted. Approved modems will carry a sticker with a green circle and the text: 'Approved for use with telecommunication systems run by British Telecommunications in accordance with the conditions in the instructions for use. BT Approval No. ....' BT may well ask which modem you want to use, and require you to quote the approval number and the name of the modem.

# LOGGING ON

ONCE upon a time when I wanted to get text to our illustrious Editor, I would call on the services of a local pigeon expert and dispatch a 'jotting', tied to the leg on Acorn Fancier's bird. However, times have changed, and Kitty no longer enjoys her trip to the top of Nelson's column to pick up the mail. Spurred on by John Coll's article (October 82) I have been looking at electronic mail and information systems available to the average Acorn user through telephone links.

There are a number of services available, including: commercial mail order systems; bulletin boards; information providers and electronic mailboxes. A system normally has one of these as a main task, but often supports additional features. For example, British Telecom's Prestel is an information provider, but items and services can be bought on Prestel, and in addition mail can be sent and received through its Microcomputing section which has recently replaced Micronet.

## Commercial mail order systems

An electronic mail order system allows people to dial a distant computer which contains a database of items, from which to choose. Prices tend to be always up-to-date, and customers can be immediately informed of items out of stock. Payment can be made by quoting credit card numbers. A typical example is Distel, which contains a catalogue of electronic components and information. Such commercial databases are expanding, so that in the future many services will be available via computer.

## Bulletin boards

Many bulletin boards are run by amateurs or user groups. On dialling a bulletin board, facilities such as read-

ing messages; deleting your own messages; writing messages and examining various activity notices are often available. Bulletin boards seem to be the computer user's equivalent of CB radio, although the American disease of 'handles' is not widespread. I don't feel inclined to reply to 'The Magnetic Surfer' on line from California, but I might talk to 'Ian Birnbaum' on line from Hull. A typical board might be Forum-80 which is based in Hull. Prestel also includes closed user groups like Micronet 800 and Viewfax. On joining these, access is automatically gained to Prestel, though not the other way round.

## Information providers

Prestel is fast being recognised as chief among the information providers. With appropriate software, it is possible to receive coloured teletext screens from Prestel on a number of topics. Prestel produces a directory of information and news items, which is delivered to members. One useful point is that many companies joining Prestel become information providers. One of the latest is Kodak, which details its current products as well as general photographic hints and tips.

## Electronic mailboxes

Electronic mailboxes provide a message service between subscribers which works on the principal of sending and receiving mail to private mailboxes. Such a system can contain confidential information, and system operators must apply the highest standards to achieve true data privacy. A typical electronic mail system is British Telecom Gold (BTG). This allows mail to be sent, received, deleted and carbon copied between users. In addition, it gives access to a noticeboard, diary and conferencing system. BTG subscribers are normally companies who operate a user group within the system,

## Baud rates

When choosing a modem or coupler, one important point to consider is the 'baud rate' which gives a measure of how fast information is carried. There are three common transmission rates:

Transmit	Receive
300 baud	300 baud
75 baud	1200 baud
1200 baud	1200 baud

Most common is the 300/300 rate, but this is quite slow and so the others are becoming more used. Modems which handle the higher rates are generally more expensive, though the range starts at about £70. Readers should note also that Prestel particularly requires the 75/1200 rate.

## Costs

Unlike many applications of the BBC computer, electronic communication has a number of costs after the equipment has been purchased, the most obvious of which is paging for phone calls. Readers should be aware that few calls will be shorter than 10 minutes. Many readers will not be within a local call of a computer system, so a 10-minute, 'b' rate call (to a system further than 35 miles) will cost £2.50 at peak time, and £1.90 at standard time. Amateurs may find cheap time best for their electronic communications.

Costs are at present:

Cheap time distance	Time for 4.4p (direct dialling)
Local	8 mins
Up to 35 miles	144 sec
Over 35 miles	60 sec

Cheap time is 6pm to 8pm weekdays and all day Saturday and Sunday. A typical 10-minute phone call to Distel will cost 44p. Distel and some of the bulletin boards are cheap, or free to access. Many of the larger ones like Prestel and BTG have other charges. Before joining any mailbox system, users must ask certain questions, as in table 1. If you don't ask these questions, quite a surprise may arrive in a phone bill or membership account. These costs can be reduced greatly by following the 'golden' rules, outlined in table 2.

## Connecting to a distant computer

How you contact a distant computer varies depending on your equipment and on the system in question. A typical sequence of events is as follows. First, connect your modem or coupler to the BBC micro and power up your own system, then load and run the terminal software. At this point many modems or couplers confirm that they are transmit-

1. What is the cost of my phone calls likely to be?
2. What is the membership fee?
3. How often must it be paid?
4. Is there a charge for 'computer time' on the system?
5. If so, what is that cost per minute or per phone call?
6. Is there a charge for storing information on this system?
7. If so, what is it in terms of cost per month per k stored?
8. Is there a charge for retrieving information stored by others?
9. If so what is it likely to be?

Table 1. Questions to ask about costs

1. Make each call purposeful; ie know what you are doing. Do it, then log off.
2. Always access the system from as close as possible, eg it is possible to enter BTG or Prestel via 18 nodes around the country. This saves phone bills.
3. Never write long messages via the phone lines. Buy 'smart' software and transmit messages from disc.
4. Get a hard copy of your favourite system's 'help' files and know how to use them before going on-line.
5. Use as fast a transmit/receive rate as possible.
6. At the end of your phone call hang up immediately. You may still be connected via BT.

Table 2. Golden rules for cutting costs

ting (for example, the Buzzbox modem and the K&N acoustic coupler pulse a 'DATA' light with each keypress). Now dial the number required on your phone and wait to be connected. When you hear a high pitched tone (from the phone) push the handset into the coupler. If you have a modem press the 'data' button. Some systems will immediately produce text on screen, but many need to hear your 'mark' to say you are there. Try pressing the return key a few times and check for a response. Once you have text on screen you are into the system. Some computers require a further stage called 'logging on'. This will require you to give some information such as name, address, and/or a password. Failure to comply often results in disconnection.

After using any system, always log off with the correct command or menu option, rather than simply hanging up, otherwise you could be paying for machine time you aren't using.

## Transmitting from the Beeb

The RS423 port on the BBC micro allows information to be sent not just to other computers but also to printers, and modems. It is therefore useful to know what is happening inside the computer whenever a signal is sent. Figure 1 shows the internal organisation of the BBC computer around the RS423 system. A signal from a key on the keyboard is processed and passed to the ACIA chip located at a particular set of memory addresses. From the ACIA the signal travels to the serial ULA from which it is sent to the RS423 output line.

If a modem is used, this signal is further modified for transmission via the phone lines.

In transmitting a byte on the RS423 system, the user provides a data byte which will always, on the BBC micro, be eight bits long. If we are transmitting to another BBC micro then sending eight bits is quite acceptable. However, some telephone systems (eg BTG) only use the least significant seven bits of a byte, and so transmission—and particularly reception—should make use of the seven-bit option in the ACIA control register. This is the complete ASCII character set, so all text characters will be transmitted.

To check on information we send an extra bit of data which is set high or low depending on the number of 1s in the byte we are transmitting called 'parity checking'. In odd parity, the number of 1s including the parity bit will be odd, while in even parity the number of 1s will be even. Considering the letter A in odd parity we would send:

A = 1 for odd parity + 01000001 = 101000001

In even parity we would send:

A = 0 for even parity + 01000001 = 001000001

## The actual transmission

Imagine we are transmitting the letter A above with eight data bits, odd parity, and one stop bit. The actual series of pulses from the RS423 port might be:

0 1000010 1 0  
Start bit lo data hi parity Stop bit

Transmission should be read left to right.

Between BBC micros, the 1s and 0s would effectively be transitions between voltage levels (figure 2). If a modem or acoustic coupler is used, the voltage levels would be converted to high and low pitched sounds, so binary 0 might be represented by a tone of say 2400Hz (though the actual tone depends on the type of modem) while binary 1 could be represented by a lower tone (figure 3).

## Simulating RS423 transmission

Program 1 (pages iii-iv) is an RS423 transmission simulator, which demonstrates each step of the process in sending a signal via the RS423 port. Once it has been typed in and saved, run it. You will be asked how many bits (seven or eight) are used to transmit data. Next the type of parity is entered, and finally the number of stop bits. In these three questions, the program will not allow word formats which are not available on the BBC micro. Errors are flagged by a beep and an error message. The opportunity to re-enter data is given at each point where an error occurs, with the exception that where only two choices occur, the computer will select the correct choice to make up the word format, after an incorrect input.

Once the three questions have been answered, the program displays the transmission screen. Whenever a CTS signal is available, shown by a light on the display panel, characters may be typed at the keyboard. Each character is shown in the box marked 'CHR'. If it is a control character (less than 32 or more than 126) then the symbol 'CTL' appears in its place.

The next stage in the decoding process is to find the ASCII equivalent of the number. This is placed in the box marked 'ASC'. On the other side of the screen is a box marked 'BINARY'. Into this is placed the binary equivalent of the character, plus the extra bits needed to make up a word for RS423 transmission. Reading from left to right there will be a start bit (0); seven/eight data bits (1s or 0s); a parity bit if parity is being checked; one or two stop bits (1s).

The final two boxes show first what might be the output from the RS423 port in terms of voltage levels, and second what might be the output from a modem in terms of changing frequencies. After the boxes have been updated, each binary digit is converted into a sound and so the complete binary word is heard as a sound something like the transmission from an acoustic coupler. (I decided against having a continual carrier tone as a constant high pitched sound can be annoying.)

Now let's run through the program structure and indicate the main procedures. PROCinit is the first procedure called. It sets up a number of character definitions, dimensions a numeric array and transfers the escape function to the CTRL-@ key. The program then enters its main loop. Exit from this is only by break or CTRL-@. The main repeat loop calls two procedures directly (PROCmenu and PROCsetscreen), then enters a further

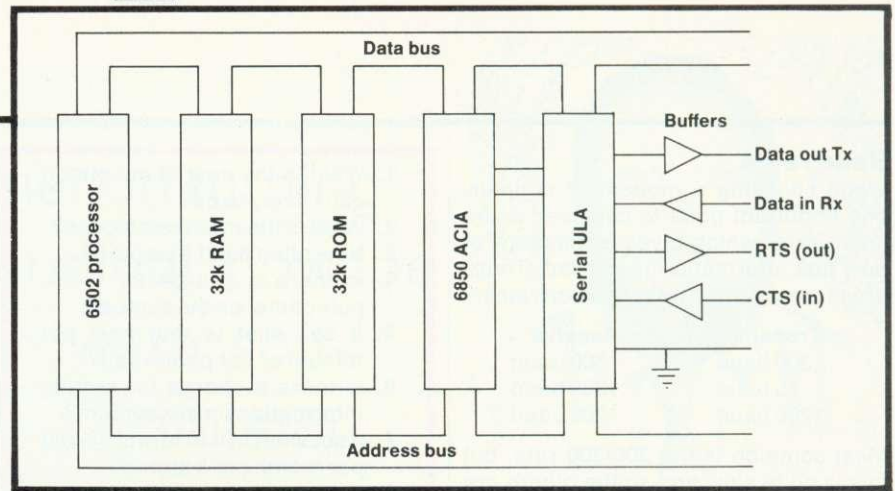

Figure 1. The BBC's RS423 hardware

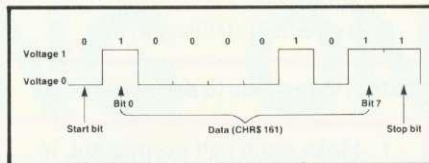

Figure 2. RS423 port output (eight data bits, no parity, one stop bit)

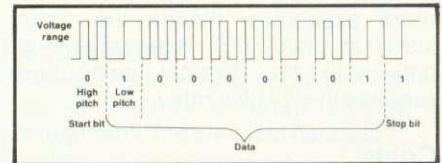

Figure 3. Output from modem (eight data bits, no parity, one stop bit)

repeat loop, which handles the actual simulation.

PROCmenu (from lines 250-450) handles the word format of the data to be transmitted. This is done by three sections, where lines 270 to 290 handle the input of data bits per word. Lines 300 to 380 handle the input of the type of parity, and ensure it matches the 'legal' BBC requirements for the number of data bits already entered. The use of the INSTR function in line 330 allows the parity input as a string to be converted to a number. In line 380, this number is further reduced to 0 (no parity), 1 (odd parity) or 2 (even parity).

PROCsetscreen is called after switching to screen mode 4 in line 70. The aim of this is to set up the screen display for the actual simulation, and in so doing, it makes much use of repeated calls to PROCrect. Once the screen is set up PROCcsr is called to turn off the cursor.

PROCrect simply takes four parameters: bottom-left, x-coordinate of rectangle; bottom-left, y-coordinate of rectangle; length of rectangle; width of rectangle; and draws the rectangle specified.

The actual simulation for any set word format is handled in lines 80 to 110. This repeat loop calls one function and one procedure, until the escape key (not CTRL-@) is pressed. When escape is pressed, the execution of the program returns to the external REPEAT...UNTIL FALSE loop, whereupon the word format is again requested.

FNtype is a short function which calls PROCcts to turn on the clear to send light, then waits for any character to be typed. To more fully simulate the RS423 CTS line, the function flushes any type ahead buffer which might

exist by issuing a \*FX21,0 at line 740.

PROCsend takes the input from FNtype and encodes it to the specified word format. To do this it relies on a number of sub-procedures: PROCbinary, PROCrs423, PROCMODEM, PROCsound. Before calling any of these, PROCcts is called again, this time to turn the 'light' off. Correctly speaking, the CTS line will not go low until the receiving computer has taken the outgoing data. The simulation appears more realistic however, if we alter the CTS indicator at this point.

PROCbinary calculates the binary word for transmission, and places it into the array 'binary()'. It then calls PROCprintbin which simply reprints the information in the correct screen box. PROCrs423 takes the information in the array 'binary()' and builds up a voltage picture in the RS423 box on screen. This is done in lines 1130 to 1150. PROCMODEM takes the information in the array 'binary()' and builds up a frequency picture in the 'MODEM' box on screen. This is done in lines 1190 to 1210. PROCsound takes the information in the array 'binary()' and transmits it via the sound command, to simulate an acoustic coupler. This is done in lines 1230 to 1250.

Although the program will satisfy many readers, it could be enhanced by the addition of a facility to read and translate random or preset data strings (ie the Rx side of transmission). Many of the necessary procedures will be the same, and hence are already written, simply calculating the binary information then calling the last few procedures in reverse should produce a useful addition. Of course an RTS function will need adding, much like PROCcts. A final thought would be to try to improve typing speed. page 38 ►



Sponsored by  
The Micro User  
and Electron User

There's much more to show.  
So this summer we go to a  
new home – to give us much  
more room to show it all!

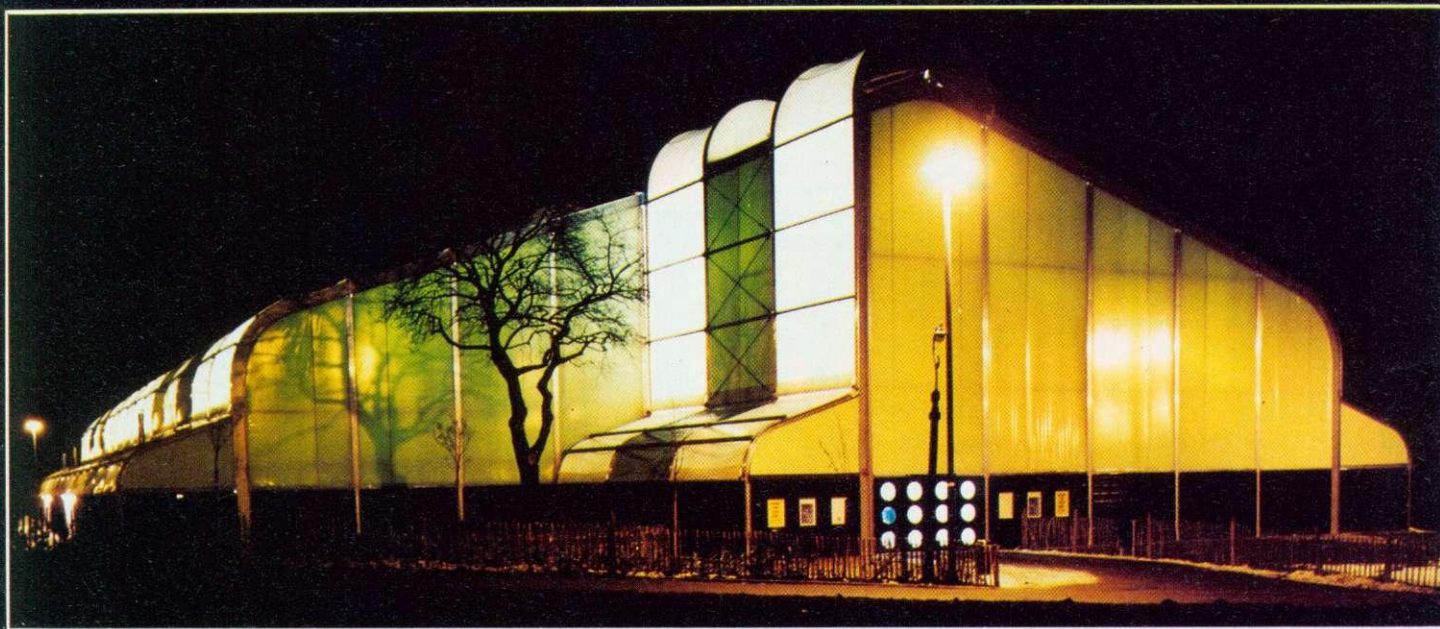

**Alexandra Palace, London, Thursday to Sunday, July 19 to 22**

**You must see for yourself all the rapid  
developments in the ever-expanding  
world of the Electron  
and BBC Micro!**

### School and College Groups

Entry only £1 per student if bookings are made in  
advance. Send your cheque (made payable to  
Database Publications) and SAE to:

Electron & BBC Micro User Show  
68 Chester Road, Hazel Grove  
Stockport SK7 5NY Tel: 061 456 8383

*Valid for a minimum of 10 people*

- ★ **SEE the latest software – hundreds of new games, educational and business programs.**
- ★ **SEE all the latest add-ons – never before have so many exciting new peripherals been launched.**
- ★ **SEE all the latest techniques – and get free advice from our team of experts, writers and programmers.**
- ★ **Make a note in your diary – NOW!**



This voucher is worth £1 per person  
off the normal admission price of  
£3 (adults) and £2 (children)  
*(Valid for a maximum of 4 people)*

### Electron & BBC Micro User Show

10am - 6pm, Thursday, 19 July  
10am - 6pm, Friday, 20 July  
10am - 6pm, Saturday, 21 July  
10am - 4pm, Sunday, 22 July

Alexandra Palace  
Wood Green, London N22

AU7

M I C R O P O W E R M I C R O P O W E R M I

# M I C R O P O W E R

FOUR SUPERB NEW B.B.C. PROGRAMS FROM

## RUBBLE TROUBLE

Crush the boulders and squash the mutant Krackats as they scavenge for food amongst the rotting ruins. Only the fittest can survive in the desolate post-nuclear wasteland. £7.95 inc. V.A.T.

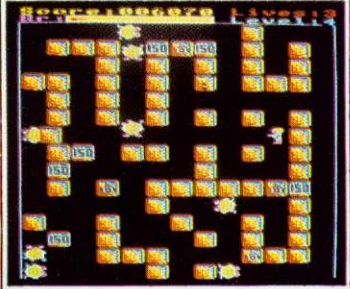

## STOCK CAR

Skid round hairpin bends, cutting up the competition and rebounding off the barriers to make a dash for the finishing line. A one or two player game featuring 6 different circuits, oil patches, selectable number of laps, variable skid, and keyboard or joystick control. £7.95 inc. V.A.T.

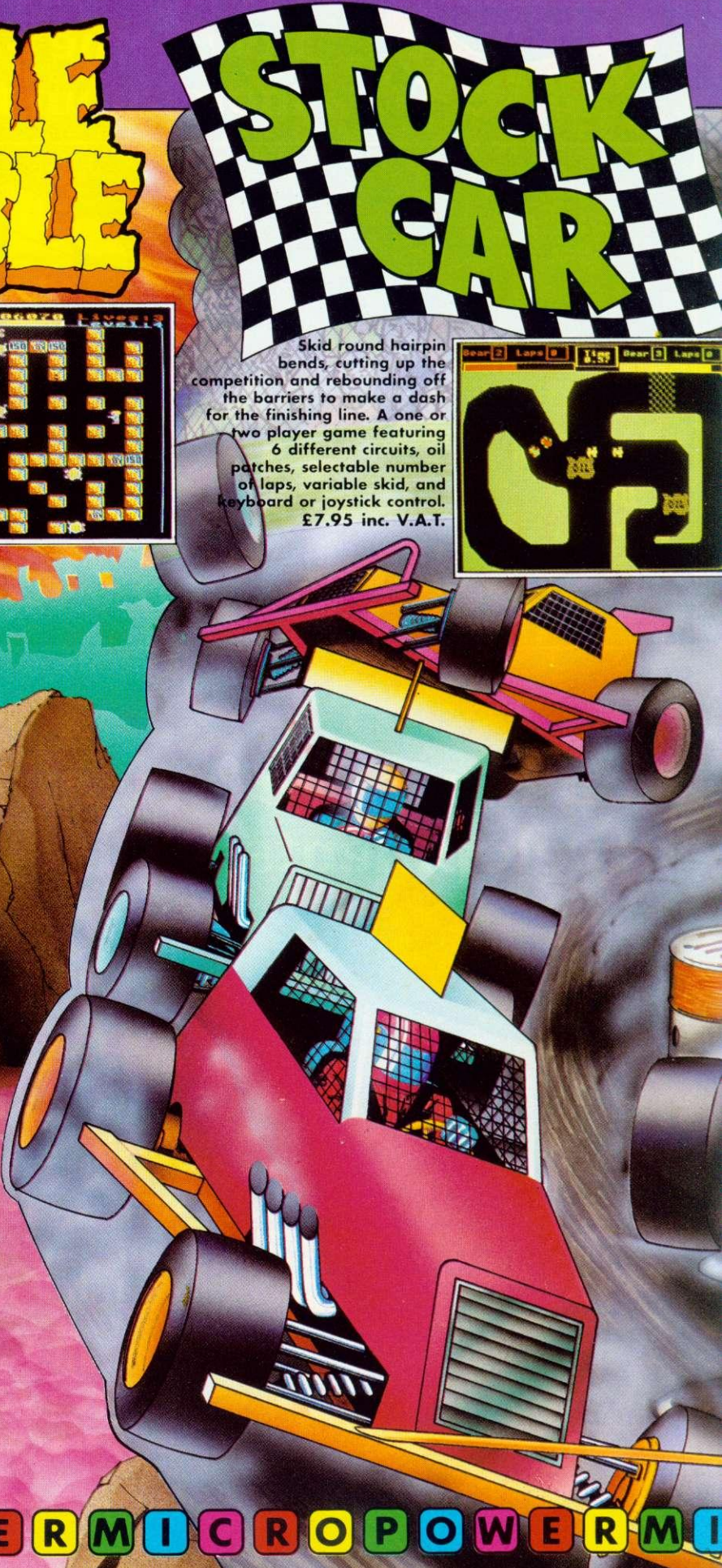
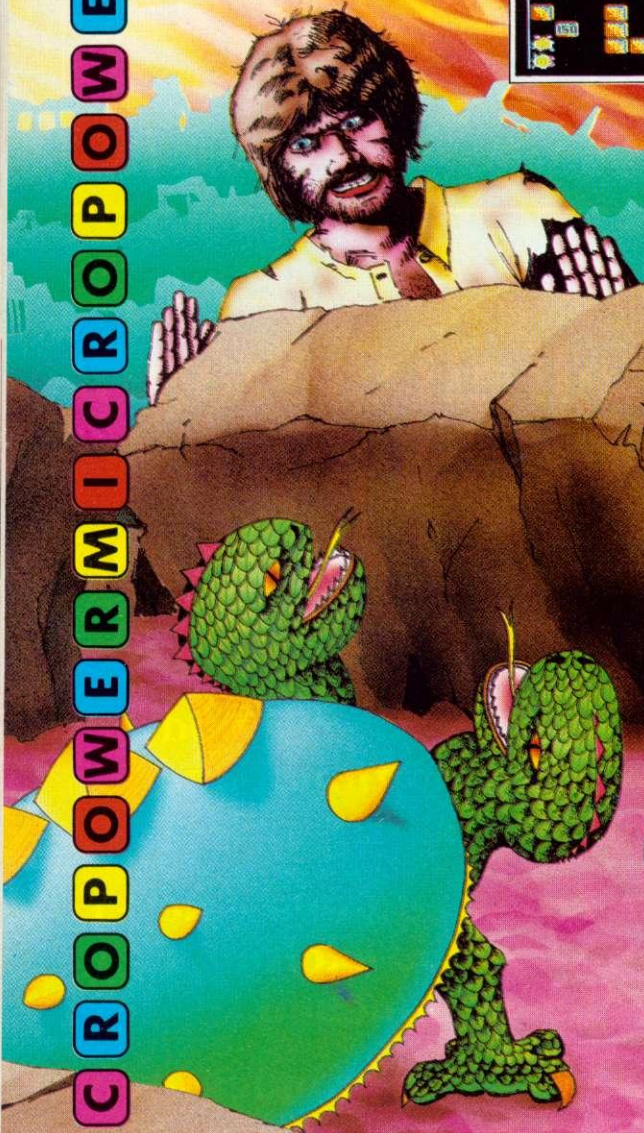
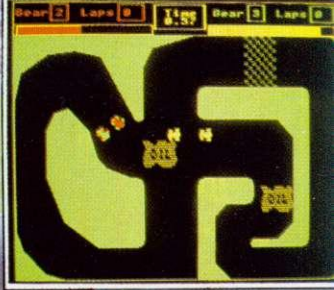

M I C R O P O W E R M I C R O P O W E R M I

ROPOWERMICROPOWERMICRO  
**MAGNIFICENT**  
 BRITAIN'S LEADING SOFTWARE HOUSE!

# BLOCK BUSTER



Bounce Harvey Rabbit from rock to rock on the Giant's Causeway. Avoid Reynard the cunning fox, the mischievous squirrels, cascading balls, and an irate albatross who are out to dash your hopes. £7.95 inc. V.A.T.

# FRENZY

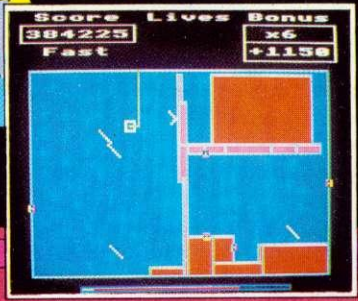

Deadly sub-atomic particles have escaped from the high security research lab. Trap the darting Leptons as they zip round the lab. Speed is essential as the heat-seeking Chasers are forever on your trail. £7.95 inc. V.A.T.



AVAILABLE FROM ALL GOOD DEALERS INCLUDING  
**BOOTS JOHN MENZIES AND WH SMITH**

The following top titles from our range are available for both the BBC Micro and the Electron: Killer Gorilla £7.95/ Bandits at 3 o'Clock £6.95/Moonraider £7.95/Croaker £7.95/Felix in the Factory £7.95/ Felix and the Fruit Monsters £7.95/Chess £7.95/Draw £9.95/Escapes from Moonbase Alpha £7.95/ Cybertron Mission £7.95/Swoop £7.95/Galactic Commander £7.95/Intergalactic Trader £8.95/ Danger UXB £7.95/Positron £6.95/Adventure £7.95.

Written any programs? We pay 20% royalties!

P & P: 55p per order.

Showroom: MICRO POWER LTD., 8/8a Regent Street, Leeds LS7 4PE. Tel: (0532) 458800.

Mail Order: MICRO POWER LTD., 8/8a Regent Street, Leeds LS7 4PE. Tel: (0532) 683186/696343.

SPECIAL OFFER:  
 Deduct £1 per cassette when ordering two or more.

Boots John Menzies WH Smith VISA Access G+S H

ROPOWERMICROPOWERMICROPOWERMICROPOWERMICROPOWERMICROPOWERMICROPOWERMICROPOWERMICROPOWERMICRO

## Comms software

Regular readers will remember how back in June 1983 we demonstrated how the BBC micro could be used to produce a 50p network. The idea was that one machine (usually with a DFS interface) could supply Basic programs to others with a simple connection and a couple of commands. Figure 4 shows the connections for a piece of five-core cable. This simple set-up has now been tried at distances over 20 metres in schools, as an inter-classroom loading system. In the home it's an easy way of stopping your children swiping your disc drives. (Keeping one's heirs out of one's hair eh? - Ed.)

Although I used a rather lengthy command line to RTX programs, much practice on the part of my daughter has reduced the sequence for transferring programs from one machine to another to that in table 3 (NB the comments in brackets may not apply to all readers).

In this way, BBC computers will swop lists without any problem at all. Points to check if problems do exist are:

- Is the lead OK? Shortened pins are common, as too are broken wires inside the plastic sheaths. The solution is a continuity tester or multimeter set to measure resistance.
- Are you using screened cable? Unscreened cable is more likely to pick up noise.
- Is the distance over which you are transmitting great? You may need pull-up resistors fitting inside the BBC micro (see *User Guide*). An alternative here might be to reduce the baud rate.
- Have you made sure the Rx micro has no program in memory? The RTX system for transmitting Basic programs is similar to EXECing programs, Txing into a 'full' micro can be quite slow.

The BBC micro will of course allow us to talk to other machines quite easily, even if the hardware handshake lines, CTS and RTS are not available. In this case communications speed might need to be reduced to 1200 baud or less, to avoid losing characters. A typical communications program for BBC to BBC might be as in program 2.

If the CTS and RTS lines are connected, then this appears to work up to 19200 baud, though note that the \*FX8,x and \*FX7,x lines have been omitted. They will need to be included in most applications. Remember, however, to set the baud rates on each machine to match. This type of terminal program is called a 'half' duplex program, because each half of the communicating system prints its own characters before transmitting them to the distant station.

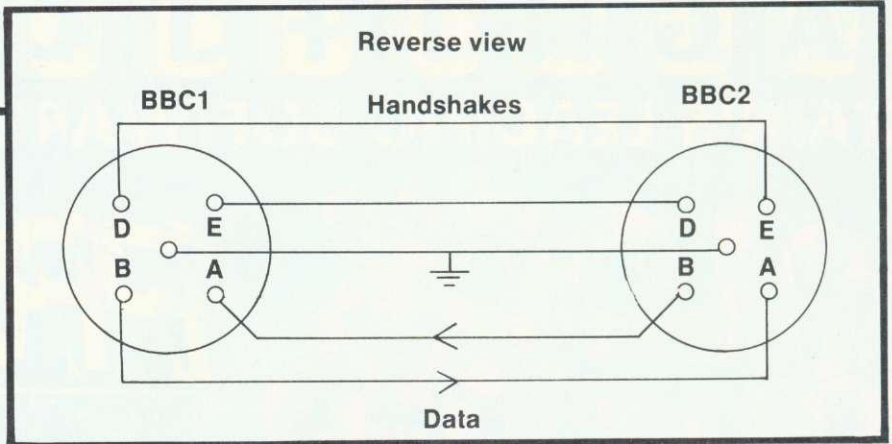

Figure 4. Connecting two BBC micros via the RS423 port

Many common systems have what is called a full duplex terminal mode. This is shown in program 3, where the distant terminal must be responsible for returning the characters typed at the keyboard. This program is set for 300baud comms by lines 5 and 6. The main body is an infinite loop which simply checks for a character entering the serial port. If one exists, it is printed. The keyboard buffer is then checked for characters, at line 20 and any character found is transmitted to the distant computer. This will continue until ESCAPE is pressed.

1. Connect lead to Rx micro.
2. Perform CTRL BREAK on Rx micro.
3. Type \*FX2,1 on Rx micro (Run down stairs. Power-up Dad's system).
4. Connect lead to Tx micro.
5. Load program for Tx-ing.
6. Type \*FX5,2 on Tx micro.
7. Type LIST(CTRL-B) on Tx micro.
8. When the program has listed, return the Tx micro to its original state (because Dad can't do adventures. Run back upstairs).
9. Press BREAK on the Rx machine.
10. Type OLD on the Rx machine.
11. The program is ready to run.

Table 3. Transfer sequence from Beeb to Beeb

When SHIFT-f0 (shifted function key 0) is pressed, character 128 is generated, and when SHIFT-f1 is pressed, character 129 is generated. We can add to our program so that whenever SHIFT-f0 is pressed, we enter mode 7, and SHIFT-f1 puts us into mode 3.

Alter line 20 to:

```
20 A$=INKEY$(0)
```

then add:

```
25 IF A$=CHR$128 THEN
MODE7:UNTIL 0
ELSE IF A$=CHR$129 THEN
```

```
MODE3:
UNTIL 0
26 IF A$ <> "" ?&FE09=ASCA$
```

Once equipped with a modem and terminal software, the 'Happy Hacker' can look for a few 'war games' to start. Perhaps the most useful commercial services are:

Distel 01-697 1888 (London)  
 Homelink (0602) 419 393 (Nottingham)  
 (or via Prestel)  
 Cashtel (0702) 552941

Bulletin boards are springing up continually, for example Mailbox 80 on (0384) 635336 or Forum 80, (0482) 859169.

## Run your own

Ever thought of running your own mailbox? This question was posed by schools in Cleveland and an experimental service is at present operating for local schools. This service, called CECCTEL, will eventually provide a software titles list as well as a bulletin service and set of mailboxes. These are all at present in an embryonic state, and experiments with downloading usable software are being carried out. Schools using the service are provided with simple software to allow communication and downloading, though at present they must provide their own couplers. The system runs at 300 baud and is overseen by a trusty BBC micro.

Providing you have an auto answer modem and a BBC micro it's not that difficult to duplicate this sort of system. I would however, encourage home-users to develop a good deal of patience because once you go on-line as a bulletin board, you will be fair game for 24-hour phone calls - and the odd visit from BT. You will almost certainly need a second line, so that your 'normal' existence of talking to people can continue, and it is imperative that the two phone numbers are kept separate.

The problem with auto-answer modems is that they need extra connecting hardware to the BBC micro. Where for example, is the 'ring detect' input to the BBC micro or the 'carrier detect' input? How can the BBC micro



latch the modem to answer while the carrier is present? These are the problem areas of most users. However, we can configure the many interfaces of the BBC micro to meet these challenges.

Latching the modem relay is quite simple. All that is needed is a voltage to be supplied to the appropriate pin on the modem. (The actual connection and voltage may vary between modems.) One simple solution is shown in figure 5 where the modem supplies the switching voltage and the BBC micro switches it via the cassette relay, given a simple procedure like:

```
DEFPROC latch(x)
  IF x = 1 THEN *MOTOR 1
  IF x = 0 THEN *MOTOR 0
ENDPROC
```

On many modems the ring detect and carrier detect signals are brought out to a connector. Examining the voltages on the corresponding pins shows a change between -6v and +6v when ringing is detected or when a carrier signal is present. This voltage can drive a small relay, external to both the BBC micro and the modem, which simply shorts to ground one of the

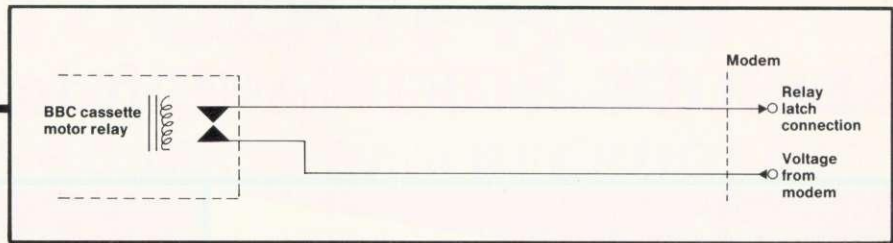

Figure 5. Latching the relay in the modem for auto answer

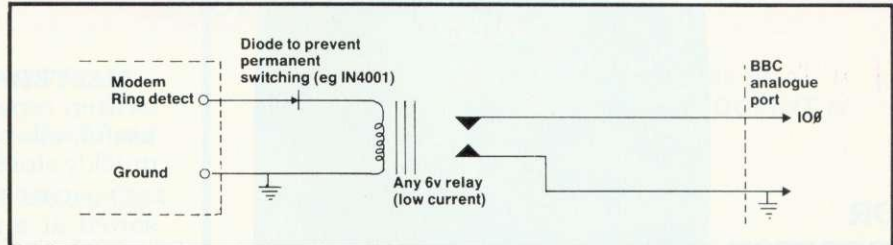

Figure 6. Passing the ring detect to BBC micro (for carrier detect, signal would go to IO1 on the analogue port)

games buttons (figure 6). A simple ring detect procedure might be:

```
DEF PROC ringdetect
  REPEAT UNTIL (ADVAL0 AND 3) = 1
  PROC latch(1)
ENDPROC
```

and a similar function for the carrier signal (which must be checked regularly) might be:

```
DEF FN carrier
  IF (ADVAL0 AND 3) = 2 THEN = 1
  ELSE = 0
```

The circuitry for passing the carrier detect is similar to that for the ring detect. If you have any worries about your competence to handle modem circuitry, then it is best to leave well alone. British Telecom do not approve of DIY modems adding extraneous (and possibly lethal) voltages to the phone lines, so remember get a BT-approved modem, or an acoustic coupler; keep any modifications between the modem and the computer; do not introduce voltages or shorts to the phone lines.

## microFAST – LATEST PRICE BREAKTHROUGH

Colour Monitors	
Microvitec 1431	£197.00
Microvitec 1451	£297.00
Fidelity CM14	£209.00

Monochrome Monitors	
Sanyo DM2112	£75.00
Sanyo DM8112CX	£99.00
Teco Zcom	£105.00

Combined TV/Monitors	
ITT RL2301	£280.00

Acorn Products	
BBC Model B	£399.00
BBC Model B with fitted disc interface	£469.00
Electron	£199.00
DFS Kit	£97.00
Data Recorder	£32.00

Torch Products	
ZEP 100	£299.00
Z80 DP2	£699.00

BBC Disk Interfaces	
Kenda Mighty Oak	£90.00
Kenda Professional (Double Density)	£130.00

Dot Matrix Printers	
Star Gemini 10X	£224.00
Star Delta 10	£365.00
KDC FT-5001	£234.00
Epson RX80	£219.00
Epson RX80F/T	£249.00
Epson FX80	£379.00

Serial Interface Conversions	
8143 - Epson	£30.00
8148 - Epson (2K buffer, XON/XOFF protocol)	£65.00
Juki	£55.00

Daisywheel Printers	
Juki 6100	£375.00
Silver Reed	£315.00
Daisy Step 2000	£289.00

Daisywheel add-ons	
Juki Sheet feeder	£239.00
Juki Tractor feed	£109.00

Product range constantly expanding, phone for latest details

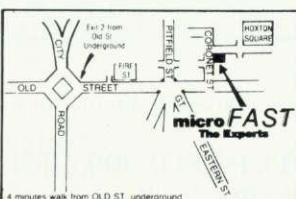

Single Disc Drives	
100K(200K) Single-Sided	
40 Track	£150.00
200K(400K) Double-Sided	
40 Track 3-inch	£190.00
400K(800K) Double-Sided	
80 Track	£219.00
80/40 Track	£248.00

Double Disc Drives	
400K(800K) Double-Sided	
40 Track 3-inch	£374.00
800K(1.6M) Double-Sided	
80 Track	£409.00
80/40 Track	£489.00

Floppy Disks	
S/S D/D 40T	£1.80
D/S D/D 40T	£2.10
D/S D/D 80T	£2.90
3"	£4.50
Library Case	£2.00
(free library case with every 10 disks sold)	
70 Disk Cabinet	£22.00

### microFAST

57 HOXTON SQUARE, LONDON N1  
 OPEN FOR PERSONAL CALLERS FROM MONDAY TO SATURDAY, 9AM TO 6PM.  
 MAIL ORDER OR OTHER ENQUIRIES  
**01-729 1778**  
 SAE for comprehensive Price List

Computer Concepts ROMs	
Disc Doctor	£32.00
Termi	£32.00
Graphics Rom	£32.00
Print Master	£32.00
Wordwise	£42.00

Acorn Roms	
View	£52.00

BBC Roms	
Ultracalc	£65.00

Full range of Software from A&F, Program Power, Computer Concepts, Level 9, Acornsoft always available at discount prices

Supplies etc	
Printer Cables	£12.00
- Extra quality	£15.00
Monitor Cables	£5.00
- CM14	£8.00
Ribbons	
- Epson	£4.50
- KDC 2-shot	£7.00
- Daisystep	£4.00
- Juki	£2.00
Paper - 2000 sheets	£12.00

Mail Order	
Software/Firmware	FREE
Hardware	£10.00

**ALL PRICES SHOWN INCLUDE V.A.T.**

These prices are for cash and carry sales

# SERIOUS SOFTWARE from BEEBUGSOFT

## SPELLCHECK

**FOR  
WORDWISE  
DISC  
£19.00**

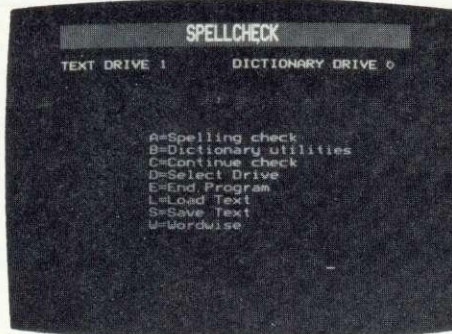

**SPELLCHECK** is menu driven, and is the ideal companion for **WORDWISE** or **VIEW**. It provides an automatic spelling check for letters or documents.

It is supplied with a dictionary disc already containing 5000 words, which may be increased to a maximum of about 17,000 words on a 100k disc.

Random access files ensure very fast word retrieval from the dictionary disc.

**SPELLCHECK** is menu driven, and is very simple to use, allowing unknown words to be added to the dictionary, ignored or re-spelt.

Incorrectly spelt words may be instantly respelt and a correct version of the document filed away, ready for printing or later use.

Dictionary discs for foreign languages may easily be created to help check letters sent abroad.

## MASTERFILE

**MASTERFILE** is a general purpose data base, written especially for the BBC Micro. It is extremely useful, allowing vast amounts of information to be quickly stored.

Once set up, the information may be retrieved or sorted at any time, in a number of different ways, using any of the fields as keys.

Records may be instantly displayed or printed, using any printer suitable for the BBC Micro, also a label printing facility is included.

Separate versions of the program are available for cassette and disc based systems. The disc version uses random access files to maximise record storage.

One extra feature of the disc version is that it provides limited spreadsheet facilities.

### TECHNICAL INFORMATION

The cassette version will allow up to 10 fields to be specified per record. Any number of files may be set up, and each file may hold about 110 records (based on a typical 5 field record).

The disc version allows up to 17 fields per record, and the only limitation as to the number of records, is the capacity of the disc. Typically, using 5 fields, about 2000 records may be stored on a 100k disc.

**DISC  
£19.00**

**CASSETTE  
£10.00**

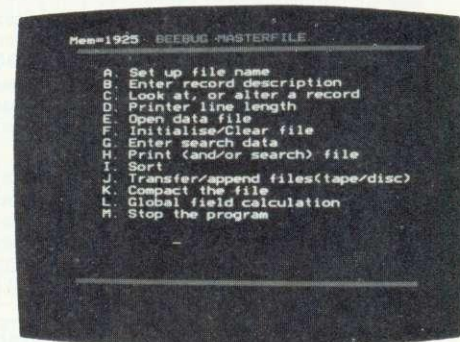

**BEEBUGSOFT, PO BOX 109, HIGH WYCOMBE, BUCKS. HP10 8HQ**

Please send me \_\_\_\_\_ Spellchecks at £19.00 each.

\_\_\_\_\_ Masterfile disc(s) at £19.00

\_\_\_\_\_ Masterfile cassette(s) at £10.00

Name .....

Address .....

Send Cheque/Postal Orders to: BEEBUGSOFT, DEPT 13, PO BOX 109, HIGH WYCOMBE, BUCKS. HP10 8HQ  
(Distribution agents for BEEBUG Publications Ltd)

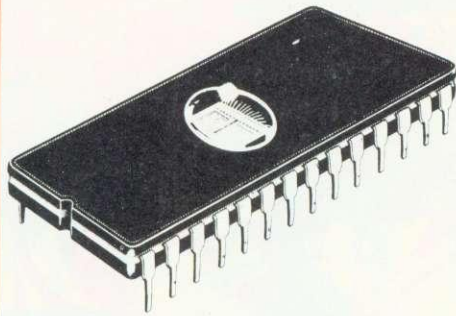

# TOOLKIT ROM

## BASIC Programmer's Aid for the BBC Micro from BEEBUGSOFT

*It is possible to program in BASIC without TOOLKIT but its not very smart*

*"TOOLKIT is an essential utility for all Basic programmers using the BBC Micro . . . The range is enormous . . . An indispensable aid packed full of powerful utilities".*

EDUCATIONAL COMPUTING MARCH 1984

*". . . Should speed up the process of programming considerably . . . TOOLKIT is highly recommended".*

PCN MARCH 17 1984

TOOLKIT is an indispensable aid to Basic programming on the BBC Micro. It gives instant access to a set of powerful utilities held in ROM.

These will get you out of trouble like the \*RECOVER, or just make life much easier, like automatic listing of error lines, search and replace, list variables, procedures . . . etc.

TOOLKIT features an extremely powerful editor, allowing the use of cursor keys to list a program line-by-line in either direction and move to any part of a program to overtype or insert new code and corrections.

TOOLKIT also contains a powerful facility to trap an error in a Basic program as it runs. It will then automatically enter the Screen Editor, display the line in error and position the cursor at the statement at fault.

### COMMANDS

*CHECK	Verify a program or data in memory with disc/cassette.
*CLEAR	Clear all variables including integers.
*EDIT	Enter full screen editor.
*FREE	Display free memory and pseudo variables
*HELP INFO	Displays various useful system information.
*MEMORY	Display memory contents.
*MERGE	Merge two programs.
*MOVE	Move program to run at specified address.
*NEW	As New, but can be issued from within a program.
*OFF	Cancel enhanced error handling.
*OLD	As Old, but can be issued from within a program.
*ON	Auto error handling – enters editor at line in error.
*PACK	Efficient program compactor.
*RECOVER	Intelligently recover bad programs.
*RENUMBER	Allow partial renumbering.
*REPORT	Extended error reporting facility.
*SCREEN	Screen dump to cassette or disc.
*UTIL 1	String Search.
*UTIL 2	String Search and Replace.
*UTIL 3	Move Basic program lines.
*UTIL 4	List Procedures and Functions.
*UTIL 5	List values of A% to Z%.
*UTIL 6	List Numeric Variables.
*UTIL 7	List String Variables.
*UTIL 8	List Names of Arrays.
*UTIL 9	Set up range for Utilities 1 and 2.

- Just plug it in, no loading necessary
- 27 new commands to make life easier
- Saves hours in program development and debugging
- Supports both cassette and disc systems
- No command name conflict with other Roms
- Ideal for expert and novice alike
- Fitting instructions and a 32 page manual supplied
- You'll wonder how you ever managed without it

Available from your dealer and selected branches of W.H. Smiths

**£27.00**  
Including  
VAT & P&P



**BEEBUGSOFT, PO BOX 109, HIGH WYCOMBE, BUCKS**

Please send me \_\_\_\_\_  
Name \_\_\_\_\_

Address \_\_\_\_\_

TOOLKITS at £27.00 each

Send cheque/postal orders to  
**BEEBUGSOFT, DEPT. 13 PO BOX 109,**  
HIGH WYCOMBE, BUCKS.  
(Distribution agents for  
BEEBUG  
Publications Ltd)

BEEBUGSOFT is the  
Software house of BEEBUG  
Publications Ltd.

It's here—the long awaited new Arcade game from Kansas

# Maniac Mower



As can be expected from Kansas, who last gave you the acclaimed Pinball Arcade, Maniac Mower is totally different from anything on the market today.

Being out of work, you jumped at the job of Park Grass Cutter. "Easy money," you thought. You thought wrong, for there is a maniac mower on the loose, hell bent on your total destruction.

With a mind of its own, it will chase you around the park as you attempt to mow to earn your wages, trying either to ram you or making you career into the mown grass—which you can't!

It's not just a matter of avoiding the Maniac though, but also making sure you don't get snarled up in the fireworks, wire, cricket balls and other debris which appears from nowhere!

To make you wish you had never taken the job on, there's a karate expert bounding around the park, only too delighted to give you a well aimed mawashi-geri.

The skill is not so much in dodging all the hazards and the Maniac Mower, but in luring it into a trap by your mowing pattern and so destroying it. Not too difficult on the early levels, but virtually impossible on the higher ones.

Nine levels of difficulty make this all-action arcade game suitable for all. Sound of course, with a musical introduction and a top score table.

This is going to be another Kansas winner...

New low price £8.50. Vat and post paid

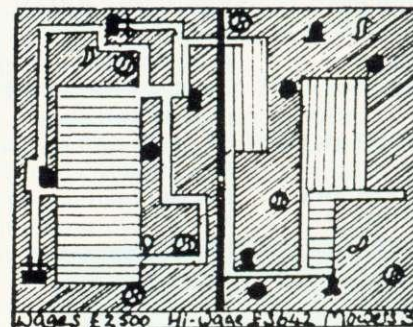
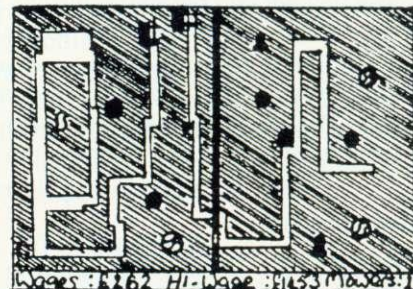

**KANSAS** the longest established software publishers in the business, now in our sixth year, backed by 27 years media publishing from the same address!

The service is the best in the country. Every order is cleared the very same day it is received, whether cheque or credit card, and despatched by our private Post Office collection at 4.30 every working day. All first class and by the faster metered mail.

Best of all is our guarantee. Should any program fail, no matter how caused, it will be replaced absolutely free of charge, this year, next year or in ten years...yes, it's guaranteed for life!

Programs are on cassette and for BBC model B. If you want delivery tomorrow, simply ring before 4pm using an Access or Barclaycard

## ALSO AVAILABLE:

### Pinball Arcade

Build your own Pinball machines and save to tape. Now five 5 star reviews including the highly respected Beebug user magazine. £10.35

### Galactic Firebird

Just about the most active Arcade game available, with the every circling swooping Firebirds, Megon Bombs and Astro Blasters. No other company has been able to do anything near. £9.50

### Arcade Scramble

The well known Arcade game, but with two types of attacking fighters, ack-ack, blimps and rockets. Another extremely active one. £9.50

### Cosmic Fighter

Four pages of attackers together with a mother ship make another fast action game. £9.50

### F for Freddie

The hardest game you will ever play, using a staggering 36 control keys to prepare, take-off, fly and land a tri-star jet. £9.50

### Fighter Pilot

Fly your fighter with the jostick and blast the enemy planes out of the sky. Land, re-fuel and take-off again. Actually see the runway, enemy, etc. Most realistic. Needs analogue joystick. £8.50

PINBALL ARCADE now available for the Electron running at its correct speed! £10.35

DRACULA ISLAND and RING OF TIME two very popular logical Adventures also available for the Electron at £8.50 each.

# Kansas

Recognised Brand Leader in microcomputer software

Unit 3, Sutton Springs Wood, Chesterfield, S44 5XF. Tel. 0246 850357

**SPECIAL OFFER!**

Deduct £1 per cassette when ordering 2 or more.

# TOP QUALITY SOFTWARE FOR THE ACORN ELECTRON

**ACORN ELECTRON**

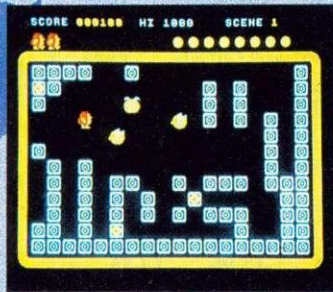
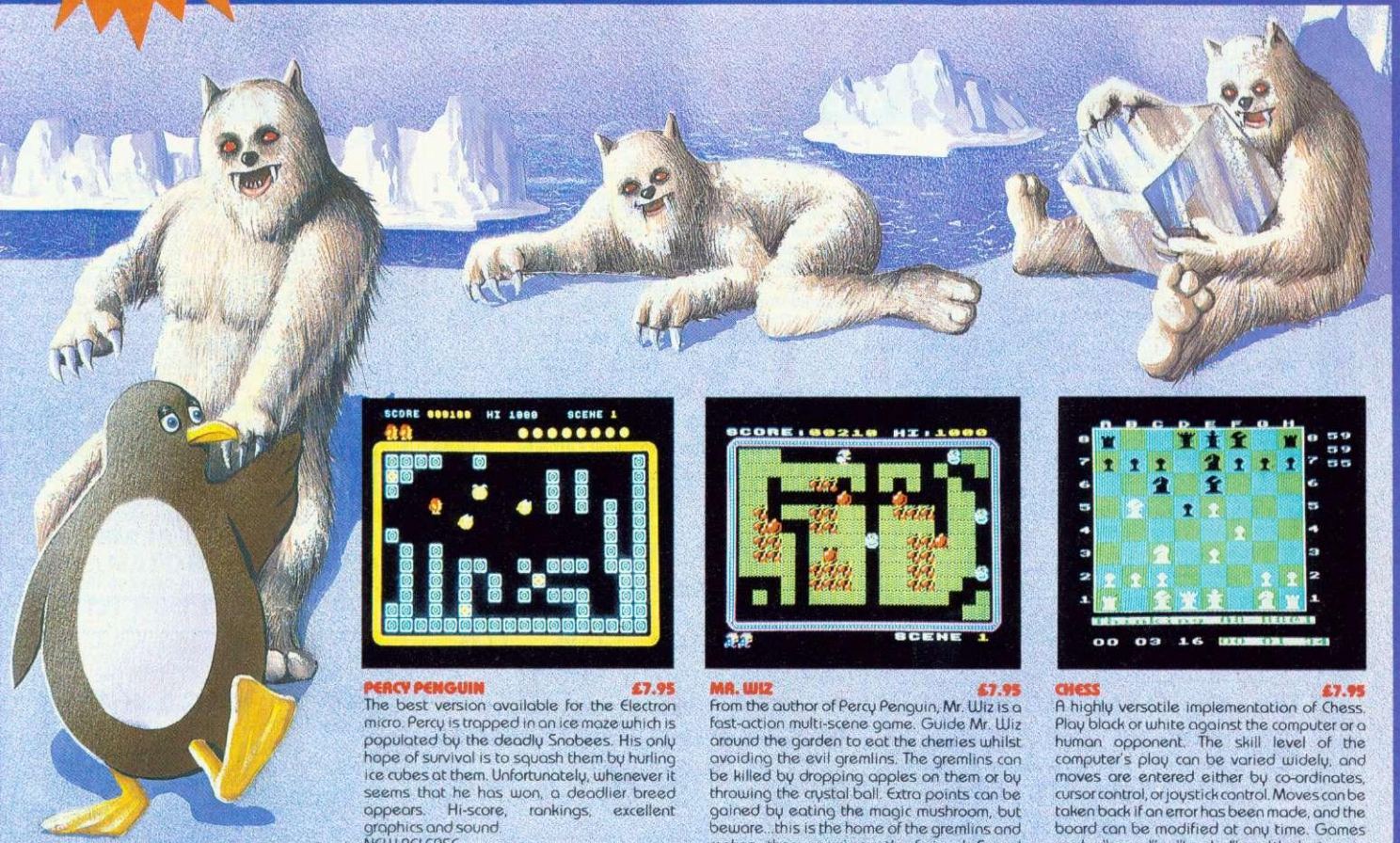

**PERCY PENGUIN** £7.95  
The best version available for the Electron micro. Percy is trapped in an ice maze which is populated by the deadly Snobees. His only hope of survival is to squash them by hurling ice cubes at them. Unfortunately, whenever it seems that he has won, a deadlier breed appears. Hi-score, rankings, excellent graphics and sound.  
NEW RELEASE



**MR. WIZ** £7.95  
From the author of Percy Penguin, Mr. Wiz is a fast-action multi-scene game. Guide Mr. Wiz around the garden to eat the cherries whilst avoiding the evil gremlins. The gremlins can be killed by dropping apples on them or by throwing the crystal ball. Extra points can be gained by eating the magic mushroom, but beware...this is the home of the gremlins and makes them permanently furious! Sound effects and tunes, hi-score, rankings. Superb arcade-style action.  
NEW RELEASE

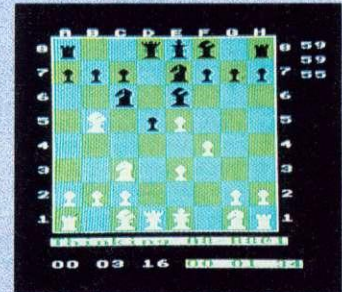

**CHESS** £7.95  
A highly versatile implementation of Chess. Play black or white against the computer or a human opponent. The skill level of the computer's play can be varied widely, and moves are entered either by co-ordinates, cursor control, or joystick control. Moves can be taken back if an error has been made, and the board can be modified at any time. Games can be "saved" or "loaded", and the last game can be replayed. The computer will, if requested, suggest your moves.  
NEW RELEASE



**CENTIBUG** £7.95  
The centibug descends from the top of the screen weaving intimidatingly between the mushrooms. Your objective is to shoot all the segments of the centibug before it reaches the bottom of the screen. Features include: spiders, snails, flies, 6 skill levels, hi-score, rankings, and increasing difficulty.



**ALIEN DROPOUT** £7.95  
A novel and unusual program. Arcade-action with this exciting multi-stage shooting game. The objective of the game is to shoot the aliens out of their "boxes" before the "boxes" fill up. Once full, the aliens fly down relentlessly, exploding as they hit the ground. The game features include: 6 skill levels, rankings, hi-score, increasing difficulty.



**STRANDED** £7.95  
An adventure game using hi-resolution full-colour graphics. You are stranded on a strange planet, and your mission is to return to civilisation and home. Many of the locations are shown graphically, including the spaceship, the cliffs, the mountains, and (if you succeed) your home. You must carefully explore your environment searching for hidden clues to help you in your quest.  
NEW RELEASE



**WORLD GEOGRAPHY** £7.95  
This program covers 166 countries which are divided into 8 categories of difficulty. Each country is pinpointed on an accurate hi-resolution screen map of the world, and the user is asked the capital and/or population. At the end of the test, the percentage of correct answers is given, so that the student can monitor his geographical knowledge.

## ALSO AVAILABLE:

INVADERS	£7.95	DISASSEMBLER	£7.95
FRUIT MACHINE	£7.95	DRAUGHTS	£6.95
CONSTELLATION	£7.95	REVERSI	£6.95

**DEALERS** - Our software is now available at all good dealers including: selected branches of W. H. Smith and Boots; all major computer dealers - Microstyle, Electronequip, 3D Computers, Computorama, GTM Computers, etc.; and our software is also available through all the major distributors, and directly from us.

**WE PAY UP TO 20% ROYALTIES FOR HIGH QUALITY BBC MICRO AND ELECTRON PROGRAMS.**



**SUPERIOR SOFTWARE LTD.**

Dept. AU8, Regent House,  
Skinner Lane, Leeds 7  
Tel: 0532 459453

## OUR GUARANTEE

- (1) All our software is available before we advertise.
- (2) All our software is despatched within 48 hours by first-class post.
- (3) In the unlikely event that any of our software fails to load, return your cassette to us and we will immediately send a replacement.



# Watford Electronics

Dept. BBC, CARDIFF ROAD, WATFORD, HERTS. ENGLAND.



Tel: Watford (0923) 40588/37774 Telex: 8956095 WAELEC



ACCESS ORDERS Tel: (0923) 50234

## BBC MICROCOMPUTER

Model A—£260; Model B—£346

### SPECIAL OFFER

For every purchase of BBC Micro during June/July, we will supply a Data Recorder worth £24 absolutely FREE. (At Watford you get a great deal for your money.)

Upgrade your Model A with our Upgrade Kits and save yourself £ s s

- BBC1 16K Memory (8 x 4816AP-3 100nS) **£24.00**
- BBC2 Printer User I/O Port **£8.10**
- BBC3 Disc Interface Kit **£99.00**
- BBC4 Analogue I/O Kit **£8.25**
- BBC6 Expansion Bus Kit **£7.75**
- Complete Mod. A to B Upgrade Kit

## ELECTRON MICRO

£199

### Dust Cover for BBC Micro

Protects your expensive Micro from foreign bodies. **£3.50**

## SEIKOSHA GP100A PRINTER

10" Tractor Feed, 80 columns, 50CPS. Normal & Double width Char, Dot res graphics. Parallel Interface standard.

SPECIAL OFFER Only: **£144** £7 carr.)

### FRICITION FEED

Attachment for GP100A or 250X Printers **£28**

GP-700 Colour Printer Screen-dump routine in ROM FOR BBC Micro

**£12**

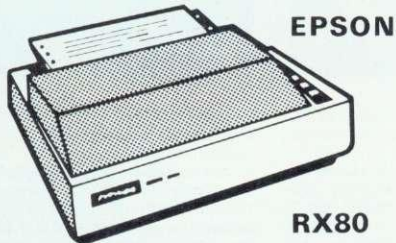

100 CPS, 9 x 9 matrix, dot addressable graphics, condensed and double width printing. Normal, Italic and Elite Graphics. Tractor feed, 10" max width, bi-directional, logic seeking. Centronics Interface standard.

ONLY **£235** (£7 carr.)

## EPSON RX80 F/T PRINTER

As above but has both Friction and Tractor Feed. **£259** (£7 carr. Securicor)

### PRINTER INTERFACE BUFFER

Neatly packaged self contained box, supplied complete with all leads, manual and detachable power supply.

Price: 16K Unit **£99**  
Price: 48K Unit **£135**

## Epson FX80 Printer

160 CPS, 11 x 9 matrix, proportional spacing, superscripts, subscripts, dot addressable graphics. Normal, Italic and Elite characters. Up to 256 user definable characters. Down loadable character set. Condensed and double width printing. Full proportional spacing. Four user defined margin positions. Tractor and Friction feed. 10" maximum width Bi-directional, logic seeking Centronics interface standard.

ONLY **£324** (£7 carr.)

## Epson FX100 Printer

Same as FX80 but has a 15" wide Carriage **£495**

Type	Ribbons	Dust Covers
MX80FT	<b>£4.75</b>	<b>£4.50</b>
MX100/FX100	<b>£10.00</b>	<b>£5.25</b>
FX80	<b>£4.75</b>	<b>£4.95</b>
RX80	<b>£4.75</b>	<b>£4.50</b>
GP80	<b>£4.50</b>	—
GP100	<b>£4.95</b>	<b>£3.95</b>
GP250	<b>£5.95</b>	<b>£3.95</b>
GP700	<b>£18.50</b>	—
KAGA KP810	<b>£5.95</b>	—

## RX & FX PRINTER INTERFACES

RS232	<b>£35</b>	RS232 + 2K Buffer	<b>£59</b>
IEEE 488	<b>£65</b>	2K Parallel	<b>£58</b>

## BROTHER HR-15 DAISY-WHEEL PRINTER

An exceptionally high quality daisy wheel printer at the price of a dot matrix printer. 18CPS; bi-directional, 3K of buffer; has clear buffer facility, carriage skip movement, proportional spacing; underlining; bold print and shadow print. Prints in two colours; super and subscript facility. Impact control facility to vary pressure on paper for making carbon copies. Has Centronics parallel or RS-232 interface. Connects directly to BBC Micro. A ribbon cassette plus a separate red ribbon. Optional extras: single sheet feeder takes up to 150 A4 sheets; a keyboard that transforms HR15 into a sophisticated electronics typewriter. Attractively finished in beige.

ONLY **£349**

Single Sheet Feeder	<b>£199</b>
Keyboard	<b>£150</b>
RIBBONS:	Carbon <b>£3</b> ; Fabric <b>£3</b> ; Multistrike <b>£6</b>

## LISTING PAPER (Plain)

1,000 Sheets 9 1/2" Fanfold Paper	<b>£7</b>
1,000 Sheets 15" Fanfold Paper	<b>£9</b>
Teletypewriter Roll (Econo paper)	<b>£4</b>

## PRINTER LABELS

### (continuous stationery)

1,000 90 x 36mm	<b>£5.50</b>
1,000 90 x 49mm	<b>£7.75</b>
1,000 102 x 36mm	<b>£6.25</b>

Carriage on Printer Paper or Labels **£1.50**

## BBC Micro WORD-PROCESSING PACKAGE

A complete word processing package consisting of: BBC Model B, Zenith 12" Green or Amber Monitor, Twin 200K highly reliable (1 year warranty) Teac Disc Drives in matching beige colour, the popular WORDWISE word processor, Watford's own highly sophisticated 62 File DFS interface fitted, the world renowned Brother HR15 Daisy Wheel Printer, Gemini's Beebplot & Beebcalc Spreadsheet Analysis Software discs, 10 blank diskettes, 500 sheets of fan-fold paper, Manuals and all the leads. To enable you to carry your Micro around, we shall pack it in our Antique Brown leatherette Attache carrying case.

ONLY **£1,249** (carr. £15)

(P.S. We will alter the package to suit your requirement. Call in for a demonstration).

NEW

## KAGA KP810

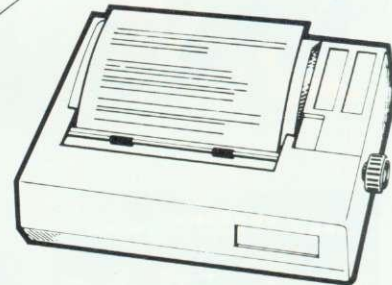

This new JAPANESE printer has EPSON FX/RX compatible commands. 140 CPS Dot matrix Printer, offers NEAR LETTER QUALITY print in a 23 x 18 dot matrix in addition to the standard Epson style type-faces on the 11 x 9 matrix. Friction feed, Adjustable tractor feed, Single sheet feed and built-in Paper Roll Holder. Normal, Italic, Enlarged, Condensed, Super and Subscript, Dot addressable graphics (8, 9 and 12 pin modes). Proportional spacing. (Optional extra) Down loadable character set in 8K ROM or RAM). NEAR LETTER QUALITY print, selectable at switch on. 10" maximum width, bi-directional logic seeking. 3K Buffer. Half speed quiet mode. Convenient Paper-out sensor switch. Centronics Interface standard. All this plus our no quibble 12 months warranty.

Special Introductory Offer: ONLY **£269**  
RS232 Interface + 2K Buffer **£8**

## KAGA KP910 PRINTER

Similar features as the above KP810 printer but has extra wide carriage. Will accept upto 17" maximum width paper. 156 column normal and 265 column condensed.

ONLY: **£349**

## PRINTER LEAD 36"

Ready made printer lead to interface BBC Micro to EPSON, SEIKOSHA, NEC, STAR, JUKI, BROTHER, SHINWA, etc., Printers.

ONLY **£**

Special Extra long 5 feet Cable **£1**

## DISC DRIVES CASED WITH CABLES (less PSU)

(All Drives are NEW SLIM-LINE Type)

### NEW LOW PRICES

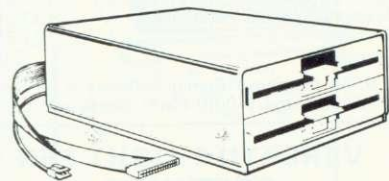

- **CLS 100** Single, TEC Single sided 40 track 100K, 5 1/4" Disc Drive **£119**
- **CLS400** Single, Mitsubishi Double sided 80 track 400K, 5 1/4" Disc Drive **£179**
- **CLS400S** Single, Mitsubishi Double sided 40/80 track Switchable, 400K, 5 1/4" Disc Drive **£215**
- **CLD200** TEC Single sided 40 track 200K, twin 5 1/4" Drives **£245**
- **CLD800** Mitsubishi Double sided 80 track 800K, 5 1/4" TWIN Drives **£359**
- **CLD800S** Mitsubishi Double sided 40/80 track switchable, 800K, Drives **£399**

## (CUMANA) DRIVES CASED WITH PSU & CABLES

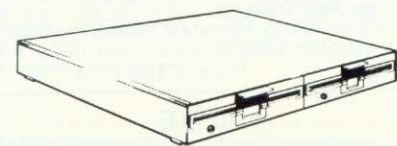
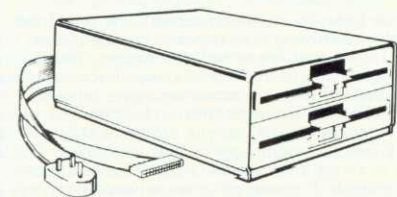

- **CS100** TEC Single sided 40 track 100K 5 1/4" Single Disc Drive **£143**
- **CS200** TEC Single sided 80 track 200K 5 1/4" Single Disc Drive **£205**
- **CS400** Mitsubishi Double sided 80 track 400K 5 1/4" Single Drive **£225**
- **CS400S** Mitsubishi Double sided 40/80 track 400K 5 1/4" Single Drive **£340**
- **CD200** TEC Single sided 40 track 200K 5 1/4" TWIN Disc Drives **£269**
- **CD400** TEC Single sided 40 track 200K 5 1/4" TWIN Disc Drives **£365**
- **CD800** Mitsubishi Double sided 80 track 800K 5 1/4" TWIN Drives **£425**
- **CD800S** Mitsubishi Double sided 40/80 track Switchable 800K TWIN Drives **£465**
- **SPARE DRIVE CABLES, SINGLE £6; DUAL £8**
- **DFS Manual (comprehensive) £7.50 (No VAT)**

S.  
You do not require Formatting Discs when using our DFS as the formatting program is in the ROM, nor do you require expensive 40/80 track switchable drives as with our DFS you can read and write 40 and 80 track discs in an 80 track drive (software switchable).  
2. **MITSUBISHI SLIMLINE DISC DRIVES** that we supply are Double Sided, Double Density 5 1/4", 1 Megabyte. (With BBC Micro 400K after formatting.) When used in conjunction with Double Density board one obtains 800K (approx) after formatting. Track density 96 TPI, track to track access time 3mSec. These drives are very fast, quiet and efficient. We strongly recommend their use.

## 5 1/4" DISKETTES

(Lifetime warranty)

Why settle for less, Buy the best.

- 10 Verbatim or 3M Diskettes S/S D/D **£17**
- 10 Verbatim or 3M Diskettes D/S D/D **£28**

## DISC ALBUMS

Attractively finished in beige leatherlook vinyl. Stores, protects and displays 20 discs in double-sided clear view pockets. **ONLY £4.95**

## PLASTIC LIBRARY CASES

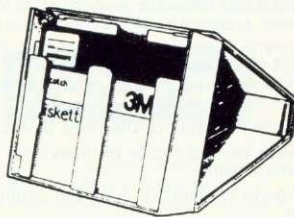

for Disc Storage 5 1/4" (holds 10) **£2**

## LOCKABLE STORAGE UNITS

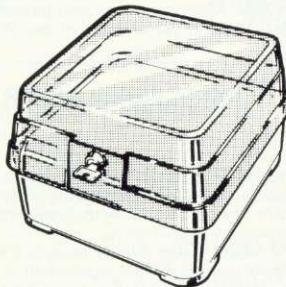

Attractively finished, strong beige plastic base fitted with dividers. Smoke acrylic top. Supplied with adhesive title strips for ease of filing.

- **M-35** Holds upto 35 mini discs **£14**
- **M-85** Holds upto 85 mini discs **£18**

## FLOPPY HEAD CLEANER KIT

Unless your office/home is dust free, you should clean heads at least once a week to avoid the risk of cross contamination. Simply apply the cleaner to one of the specially formulated cleaning discs, insert into the drive and initialise. If your system has no initialisation program then insert the disc and open and close the door 5 times.

**£16.00**

## MONITORS

**MICROVITEC 1431**  
14" Colour Monitor, RGB Input. (as used in BBC programmes) FREE Interface Lead. **Special Offer £174**

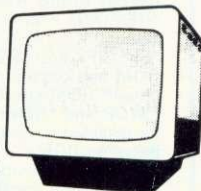

- **MICROVITEC 1451** Hi-res 14" Monitor incl. lead **£295**
  - **NEW MICROVITEC 14"** Colour Monitor/Composite Video **£249**
  - **KAGA RGB 12"** Medium Resolution Colour **£195**
  - **KAGA RGB 12"** High Resolution Colour **£259**
  - **KAGA 12"** Standard resolution colour MONITOR/COMPOSITE VIDEO **ONLY £195**
  - **BNC** Connecting Lead **£3**
  - **RGB** Connecting Lead **£5**
  - **ZENITH 12"** High resolution, jitter free picture, Amber or Green **£75**
- Carriage on Monitors £7 (Securicor)

## EPROM PROGRAMMER

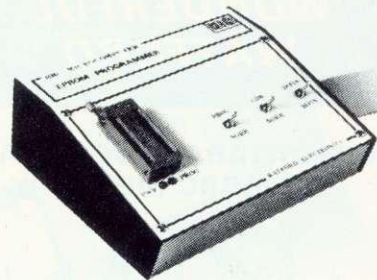

At last! - the EPROM Programmer for BBC Micro Computer from WATFORD ELECTRONICS that will suit both your pocket and all your requirements. Programs all popular types of EPROMS from 2K bytes up to 16K bytes - **2716 - 2516 - 2532 - 2564 - 2764 - 27128**. Our Programmer has been designed to make sure the EPROMs are neither programmed too fast nor too slow; just at the right speed as recommended by the manufacturers of the EPROMs (any deviation in timings can burn their brains out).

This extremely powerful system is designed for your needs of TODAY & TOMORROW! - BBC Basic programs can be copied into EPROM and subsequently re-loaded faster than from a disc! Suitable for both hobbyist and professional users!

Just look at these features:

- **COMPLETELY SELF CONTAINED** - Housed in its own sturdy case - Uses its own power supply - connects directly to the 1MHz Bus - Simple and Safe!
- **FULL SOFTWARE SUPPORT** - Comes complete with simple to use fully machine code ROM based software and easy to understand manual. Facilities include Verification, Reading, Virgin Testing, Writing, Editing, Saving, Loading and more! NOTE!! - This software does not simply comprise hastily prepared routines to get you going, but is a professional, purpose designed applications package.
- **ACORN BUS COMPATIBLE** - Use of the 1MHz connection complies with all Acorn addressing recommendations - That means you can still add-on such things as the TELETEXT, IEEE 488 TUBE and PRESTEL
- Allows more than one program to reside in an EPROM using the ROM Filing System.

**ONLY £89** incl. Manual (£3 carr.)

## TEX EPROM ERASERS

EPROMs need careful treatment to survive their expected lifetime. Rushing it could burn their brains out. So cop-out of this helter-skelter world; take it easy the TEX way and give your chips a well earned break. Cool, gentle and affordable. EPROMPT does it properly.

Two versions available:

- **EPROMPT EB** - The standard version. Erases up to 16 chips. **£30.00**
  - **EPROMPT GT** - Erases up to 28 chips. Has an incorporated safety switch which automatically switches off the UV lamp when the Eraser is opened. **£33.00**
- Spare 'UV' Lamp bulbs. £9

## SWIVEL MONITOR BASE

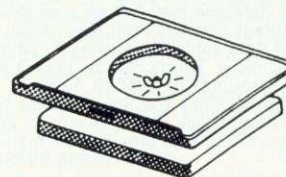

Attractively finished in beige, our swivel base allows you to tilt/swivel your Monitor to any required angle for comfortable viewing.

**ONLY £18**

Continued →

# WONDERFUL WATFORD

## TWO DATABASE SOFTWARE for BBC MICRO

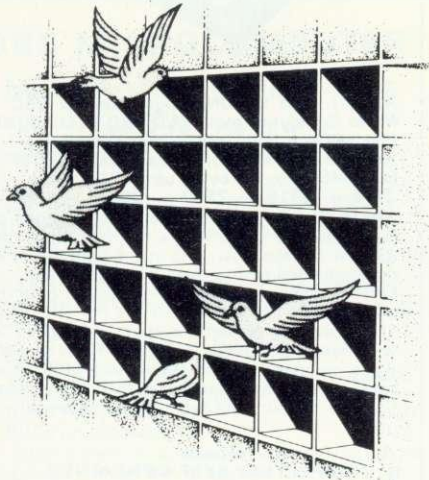

### DISCDATA

At last for BBC Micro Disc users, Watford Electronics have produced 'DISCDATA' which must be the most versatile general database at the price on the market. The length of your files is restricted only by the space on your disc. You can have up to 20 fields with 'page' length records of up to 254 characters. The program is completely menu driven obviating reference to a manual although written guidance is given with the program. Add and delete records, amend title, field names and records, sort on any field and search for any record or group of records in any field. You do not need to abandon or rewrite your files if you wish to add additional fields or extend the length of any field, the program will rewrite the files for you. Your files can be in any drive. Output can be in 40, 80 or 132 character width with Printer routines. Two forms of output are provided for horizontal for label type output and a tabulated output with title and headings. What is more, the selected fields can be placed in any order on the screen. In the horizontal mode you can scan backwards or forwards with wrap around effect. Output can be started or stopped anywhere in the file. There is automatic totalling on decimal fields and an automatic count of the number of records output. Now with extra 3 features: Allows string search; Calculations can be done on numeric fields; Create Sub-Files from the main File.

On disc at **Only £15**  
It has to be the best value.

### FILE-PLUS

Now even more powerful with the added facility of a SHELL SORT on any field. This must make DATA-PLUS the most powerful and versatile Database to be found on BBC Micro. A 16K ROM containing the most flexible and easy to use disk based Database system on the market. A database may occupy your total on-line storage capacity. You may design any number of data entry forms using a "paint" on screen technique. Forms may be up to 3 screens in size. A form may be used to Add, Delete, Update, Print and Spool records from your Database. Quick search facility on any text field. A query language provides full maths support (-, +, /, \*, +9999999999.9999) and compare facilities (=, >, <, <=, >=, &, !) when used with the keywords - Assign, Compare, Display, End, Goto, Iff, Lft, Print, Read, Search, Spool and Update. Full printed output control via embedded commands. Supplied with 70 page manual and fitting instructions.

**Only £43**

## BUFFER & BACKUP ROM

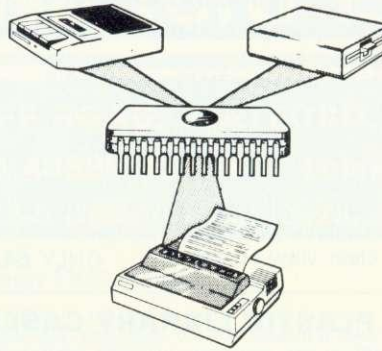

A very versatile firmware. An ideal ROM for engineers, programmers, teachers, students, etc.

- ★ Converts your Sideways RAM to a 4K or 16K BUFFER for a parallel printer. (Uses \* FX5,3). (You no longer require to purchase expensive (£100+) Printer Buffers.)
- ★ Dumps selection of Disc files to Tape.
- ★ Makes backup copies of tapes onto Tape, Disc and Hobbit.
- ★ Displays contents of a chosen paged ROM on screen.
- ★ Menu display on 'shift-break' using ROM Filing System.
- ★ Comprehensive Manual

Simply a give away at **£18**

In keeping with our tradition of bringing you the best in BBC Micro at prices you cannot refuse, we are launching yet another of our ROM based software.

## NEW LAUNCH ROM MANAGER

This unique piece of firmware has been designed to allow the USER to access the BBC Micro's Sideways Rom Paging facility to the full. The 18 Commands our ROM MANAGER adds to your computer are concerned with 3 aspects of ROM use:

1. ROM CONTROL - Ability to activate at random any of the ROMs present in the Micro.
2. BBC MICRO's STATUS - e.g. Checksum on any ROM, and the Filing system currently active.
3. ROM DEVELOPMENT - Allows main memory to be used like Sideways RAM.

The Commands available are:

- \*CHECKSUM - generates a CRC for the specified ROM.
- \*DIRECT - allows you to pass a particular command to the specified ROM.
- \*EXAMINE - allows examination of the named ROM.
- \*EXPLAIN - gives detailed description of the first 22 FX codes.
- \*FILE - passes the command directly to the currently selected filing system.
- \*FUNCTION - displays the string currently programmed onto the function keys.
- \*INCLUDE - allows the main memory to be used for developing ROM software without need to purchase expensive sideways RAM.
- \*MODIFY - any location in memory is displayed and can be modified with this command.
- \*NAMES - displays the names of any resident ROMs.
- \*RAM - allows the command to be passed directly to the 'RAM based ROM'.
- \*REMOVE - turns off the 'RAM based ROM' option.
- \*SPECIFY and \*DEFAULT - specifies the default ROM and passes the named command to the default ROM specified.
- \*STOP and \*START - allows the named ROM to be disabled or enabled, preventing clashes between ROMs.
- \*STATUS - provides information about the ROMs inside the BBC micro, including the socket number, the name of the ROM, its length, whether or not it is enabled and supports language or service entry points.
- \*VALUES - outputs information concerning the status of ROM MANAGER e.g. the socket number it occupies, the number of active ROMs with a higher priority than itself, the current filing system.
- \*VECTOR - the same function as \*DIRECT, but provided in case \*DIRECT clashes with other ROMs.

In our opinion this ROM is one of the most useful utility ROMs available on the market, and is a must for anyone using ROM based software.

Introductory Price: **Only £19**

## GEMINI'S BUSINESS SOFTWARE

Cashbook Accounts	£52
Final Accounts	£52
Invoices & Statements	£17.25
Commercial Accounts	£17.25
Mailing List	£17.25
Database	£17.25
Stock Control	£17.25
Home Accounts	£17.25
Beebcalc Spreadsheet Analysis	£17.25
Beebplot	£17.25
Payroll	£39

N.B. All the above Gemini software is on tape  
For Disc Based (40/80 track) please add £3

## VERSATILE LIGHT PEN SOFTWARE

- Enjoy, Explore, Educate!
  - Pixil, Line, Character Definition
  - Free hand drawing
  - All Colours - MANY Special Effects
  - Fill, Refill and Stripes
  - User defined "Brushed Strokes" plus Character definer
  - Grid, Scale, Perspective aids
  - 2 TO 200 Points palletable in one Design with Circles and "RUBBER BANDING"
  - Move design/character to any screen position
  - Save and Load screens, User defined Graphics and line drawings for video titles, Own programmes, etc.
  - Many Educational uses
  - Instruction booklet included
  - Full software support for "CUSTOM USE"
  - Works with Watford, RH, Acorn User, DIY, and many other LIGHT PENS
  - Available on DISC or TAPE
- Price: Tape **£10**; Disc **£11**

## DISC EXECUTOR

Disc Executor is a highly sophisticated disc utility which allows you to transfer all tape based software that we know of onto disc. You no longer have to throw away any of your cassette based software on acquiring a disc drive. It handles 'locked' programs and allows you to load full length adventure type programs (i.e. up to & 6E blocks) and programs that load below & E00. It is very simple to operate (full instructions supplied). It saves you your valuable time and money too. Our Disc executor is not a Replica, it's the 'Real Thing'.

Available in both 40 and 80 track discs. Please specify when ordering.

Price: **£10**

## ADE

The complete program development package on 16K ROM. A must for all the Assembly Language Programmers.

Introductory price: **Only: £52**

## GAMES SOFTWARE

CHESS	£6.95
CROACKER	£6.95
Escape from MOONBASE ALPHA	£6.95
CHUCKIE EGG	£7.90
FELIX in the FACTORY	£6.95
GALACTIC COMMANDER	£6.95
KILLER GORILLA	£6.95
MUNCHYMAN	£5.95
MOONRAIDER	£6.95
MUSIC SYNTHESISER	£8.25
PENGO (Watford)	£7.75
SWOOP	£6.95
Twin Kingdom Valley	£8.25
747 FLIGHT SIMULATOR	£7.75

## LEVEL 9 ADVENTURE GAMES

COLOSSAL ADVENTURE. The classical mainframe game "Adventure" with all the original puzzles plus 70 extra rooms.

**£8.65**

ADVENTURE QUEST. Through forest, mountains, desert, caves, water, fire, moorland and swamp on an epic quest vs tyranny.

**£8.50**

DUNGEON ADVENTURE. Over 100 puzzles in the Demon Lord's dungeons.

**£8.50**

SNOWBALL. Save a 7000 location colony starship in 2302 AD.

**£8.50**



# BEEBMON

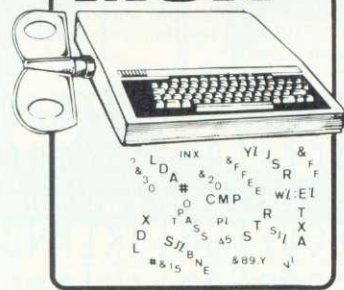

Watford's own Machine code Monitor ROM written by Andrew Bray (Cambridge), co-author of the BBC Micro Advance User Guide.

The most powerful and versatile machine code monitor ROM yet written for BBC Micro. It has all the normal memory editing, moving and locating facilities, plus all editing is with a full screen editor allowing scrolling up and down memory, entering in Hex, ASCII or standard assembler mnemonics.

Use as a debugging tool, you run code under total emulation system. Ever felt a desperate urge to set a break point in ROM? No problem you can even have breakpoint on reading or writing locations in memory and on register contents. The system fully supports debugging sideways ROMs e.g. BASIC can fully and easily be run from within Beebmon and from here DFS and other sideways ROMs can be used in total emulation mode.

Beebmon can even run itself. In so doing you can nest Beebmon up to a level limited only by memory size. Beebmon uses 256 bytes of workspace, located anywhere in memory, even on the 1MHz Bus. Beebmon effectively uses one page workspace, so your program (e.g. BASIC) can use any or all of the base page. How does it achieve this? By providing a 6502 interpreter all programs running under it exist as a virtual BBC, so special memory locations like the ROM latch are not actually accessed by your programs, instead they alter a location in Beebmon's workspace. Emulation also allows immediate return to Beebmon command level by ctrl-escape no matter what code is being executed at the time. All this exceptional power and flexibility is complemented by a clear and detailed manual included in a value for money price of:

£22

## Disassembler Rom



Discover the hidden secrets of BASIC and the OPERATING SYSTEM with this easy to use programmers tool.

ROM based machine code Disassembler for the BBC micro. It enables machine code programs to be listed in BASIC/DUMP format and thus is the perfect complement to the built in assembler. It allows Sideways ROMs, files on disk or tape to be listed, and also has a comprehensive editor, allowing mnemonics to be entered directly, as well as HEX, DECIMAL, ASCII and BINARY memory editing. There is also a full set of labelling facilities available (up to 3,200 labels), with the major locations and routines already labelled.

Plus DIS-ASM enables any monitor program, such as BEEBMON to be used to much greater effect as it is not necessary to disassemble memory each time the display is altered.

ONLY £16

Price includes a comprehensive manual and operating instructions.

## Computer Concept's

Graphics ROM £27

## CARETAKER

The New Basic Utility ROM from Computer Concept £28

DISC DOCTOR £26

A sophisticated Disc Utility ROM with many useful commands. (For detail description please refer to Computer Concept's advert in this magazine.)

## Wordwise

Without doubt a very sophisticated piece of software for the BBC Micro. It has all the features of a professional word processor yet is easy to use.

SPECIAL OFFER THIS MONTH: £32

NEW

LAUNCH

## THE INVESTIGATOR

Now you can make up back-up copies of all your Discs. Put the precious originals away in the safe and use your duplicates.

See what your 8271 can do! With Watford's Investigator you can find out about track formatting, sector length, etc. Investigate your disc and then make up your back-up copy. Format your discs to your own individual specification! Find deleted Data! Spot unformatted tracks!

Disc based software includes a comprehensive manual.

Price: £15

(Please specify 40 or 80 track when ordering)

## PENGO

The popular 100% machine code arcade game now at a special offer price of

Only £6.95

## CRAWLER

A new challenge for your reflexes, exercise for your fingers. Crawler is the best yet BBC version of the popular arcade game "CENTIPEDE". Blast the voracious caterpillar before it eats you. Avoid the wandering spiders. Shoot the scorpions before they poison the mushrooms. Kill the descending fleas as they cause massive mushroom growth. This game is a delight to play. The controls are responsive and fast yet precise.

Only £5.95

## LIGHT PEN

Light Pen for BBC Micro including Software cassette and operating instructions.

Only: £16

**WATFORD - Always a step ahead**

## GRAPH PAD

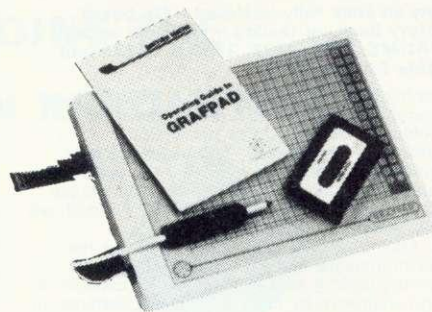

With this popular British Micro's Graph-pad, you can add new dimension to your computer enjoyment. It helps you to create your own application programs by the simple use of the Graphpad. Ideal for Educational use. Supplied complete with Cables, Manual and a two program cassette.

Price: £125

## BEEBLOTTER

The Unique Graphic Tablet

Watford Electronics' BEEBLOTTER will work with 32K BBC Micro. Connects to Analogue port. The unique design makes it accurate and simple to use. Attractively finished. The comprehensive booklet supplied describes its use in detail and shows some of the possible applications.

The special features include:-

- Works in all graphics mode and any colour selectable.
- Commands printed on Tablet and On-screen instructions.
- Special routines enable pictures to be quickly loaded from tape.
- Works with all operating systems and ECONET. Tape and Disc versions available.
- Large drawing area (32cms x 23cms).
- Maps, Pictures and Diagrams produced quickly and easily.
- Transparent tablet enables maps and diagrams to be copied directly from books.
- Commands include line, circles and rectangle drawings, infilling, full editing and an easy to use copy and move feature.
- Screen dump routines included for Seikoshia and EPSON printers.
- Routines are included to allow user to incorporate pictures in their own programs.
- Designed by a professional teacher with educational uses in mind.

At a knockdown price of:

ONLY £59 (£3 carr.)

## SURGE PROTECTOR Plug

Safely eliminates dangerous voltage surges. During a thunderstorm, a nearby lightning strike can induce high voltage spikes in the voltage supply or fluctuating loads can also result in transient overvoltages which if unchecked, lead to expensive data corruption/loss. Our surge protection plug will provide the necessary surge protection. Simply replace your standard 13Amp mains plug with the surge protection plug (which is almost the same size). Ideal for computers, Hi-Fi systems, precision instruments, fridge freezers, etc. Max. surge current 2KAmp; Max. Voltage 250 Volts. A must for all serious computer users.

Price: £8.95

**WATFORD ELECTRONICS**

Continued

## MK 2 13 ROM SOCKET EXPANSION BOARD

Now all lines fully buffered – On board battery back-up facility – will now accept EPROMs 2716, 2732, 2764 & 27128 and ROMs 6116 & 6264.

Simply plugs into one of the four ROM sockets currently available in BBC Micro. There are only 5 solder connections to be made. Full instructions are supplied. This board has been ergonomically designed to enable the user, easy further expansion inside the Micro, e.g. Double Density Board, Torch Board, etc. (At Watford, we think ahead.)

Our Mk2 13 ROM Socket Board enables the User to increase the sideways ROM capacity from the basic 4 sockets upto full 16 capable of being supported by current operating systems. In addition the board is designed with the facility to hold upto 16K RAM, which when switched into operation is automatically selected by any WRITE signal to the Sideways ROM area. This gives the User the ability to write a utility or language and upon pressing break have the utility or language up and running (new ROM software can be developed and tested in situ.)

The Board gives the User, plenty of freedom to explore the possibilities of the new paged ROMs due in the coming months and offers them the chance to develop their own.

All lines are fully buffered and the Board meets or exceeds all timings for operation in the BBC Microcomputer. When fully populated, the ROM Board consumes less than half the recommended maximum current limit.

Supplied ready-built and tested complete with fitting instructions.

**ONLY £32.50 (carr. £1)**

## EPROMs & CMOS RAMs

2764-250nS (8K ROM)	<b>£5.95</b>
27128-250nS (16K ROM)	<b>£24.00</b>
6116-150nS (2K RAM)	<b>£6.50</b>
6264-150nS (8K RAM)	<b>£36.00</b>

## BEEB SPEECH SYNTHESISER

Versatile Speech Synthesiser Unit for the BBC Micro



**SIMPLY** the best! – An unlimited speech synthesis system. Complete with easy-to-follow manual. Controlling software is in ROM so no Cassette Loading problems!

**PHONEMES** for word synthesis – That means unlimited vocabulary! No extra speech dictionary chips to buy!

**BUILT-in** Library of approximately 500 words to get you started.

**ENGLISH** accent – Utilises inflexion techniques to produce highly comprehensible speech.

**EASY** to use system – Just plug the software ROM into a socket, the Speech unit into the User Port, and away you go! No specialised 'dealer upgrade' required!

**COMPACT** unit – The whole system is built into a small case – easily tucked behind the computer. Auxillary output socket provided for direct connection to an external amplifier.

**HOURS** of fun! – Suitable for any application – Games, Educational Programs, Specialised Packages.

We know this all seems to good to be true but **DON'T BE LEFT SPEECHLESS!** Order your Versatile Speech Unit now!

**Only £44**

## THE ULTIMATE DFS FOR BBC MICRO

by



Highly acclaimed at The ACORN and BBC MICRO USER Shows. What do the independent press say?

Good value for money – *Beebug Aug. '83*  
A very worthwhile package – *The Micro User*  
You'll be buying a very powerful package – *Personal Computer News*  
Superior DFS: Excellent disc sector editor – *Computer Answers*

Without a doubt, the most sophisticated DFS Software yet written for BBC Micro Computer. This powerful new DFS is fully compatible with ACORN DFS yet has much increased power due to additions, carefully designed to make life easier in normal use. It consists of over 14K of efficiently written machine code. It is entirely self contained and so does not require a utilities disc to function.

- The system can either use the ACORN standard 31 files per disc side or DOUBLE THE CAPACITY to 62 files. The size is selected at formatting time. Copying between discs with different catalogue sizes works perfectly normally.

- A FORMATTING PROGRAM is built in, permitting formatting to 35, 40, 80 track formats with either 31 or 62 files. Since the formatter is built in to the DFS it can be used without affecting whatever program you are using.

- A DISC VERIFIER is also built in. This checks the internal checksums on each sector to identify any corrupted data. This is extremely useful when saving valuable data as it shows faulty discs quickly and easily. Again it does not affect the program you are using.

- A built in DISC SECTOR EDITOR gives a screen window onto the disc enabling detailed editing of any byte on the disc. This is very useful for recovering accidentally deleted files and can save weeks of work.

- A double step mode allows the User of 80 TRACK DRIVES TO READ & WRITE BOTH 40 and 80 TRACK DISCS. This mode is software selected for each drive individually, thus enabling a 40 track disc to be copied on to an 80 track very easily. THIS ELIMINATES THE NEED FOR EXPENSIVE 40/80 TRACK SWITCHABLE DRIVES.

- A WORKFILE function sets the name to be used when the null filename is issued. This allows a program to be edited and repeatedly saved having only typed its name once.

- When using LOAD, CHAIN, etc. it is possible to specify an ambiguous filename. This will result in the first file whose name matches the specification being used. This saves typing the end of a filename that you know is uniquely identified by its first few characters.

- Two commands exist to simplify the transfer of programs from TAPE TO DISC. These load the file to & 1100, switch off the disc system and then move the file to its correct load address; thus saving a lot of complicated programming. This command can be used to load files up to 27K75 long.

- An advanced COPY command is included which will prompt the user, requesting whether to copy each file.

- RENAME has been extended to allow the use of ambiguous filenames. This allows you to change BERT1, BERT2, BERT3 to FRED1, FRED2, FRED3 with only one command.

- OPENOUT has been improved to give you fewer annoying 'Can't extend' errors, as it automatically picks the biggest space on the disc in which to put a file. A SPACE command lets you know how much space \*COMPACT could create before you waste time doing it.

Continued:

## BEEBFONT ROM

BEEBFONT is a remarkable new concept in BBC software, exclusively available from Watford. Once fitted, the 16K ROM will enable you to produce attractive text displays in following different styles:



- ★ It works in modes 0, 1, 2, 4, using full colour.

- ★ Simply use Ctrl-V to select the font and all further screen output will be in a new style.

- ★ Even the ordinary Beeb character set can be enhanced by doubling height or width and emphasising to give bold print.

- ★ A comprehensive editor is included which enables the user to design his own characters.

- ★ A spooling program is provided, which enables pre-formatted text files to be displayed on an EPSON FX, RX, and NEC Printers, using the full range of character styles. (Please specify printer type when ordering). Can be used with WORDWISE.

- ★ This really must be one of the most original and exciting products of the year.

- ★ A twenty page manual is provided and the demo/editor software comes on disc or cassette (please specify when ordering).

**ONLY £3**

DFS continued:

- 2K of RAM can be reclaimed from the DFS by setting "PAGE" to & 1100.

Now with extra features:

- The powerful library system has been extended so that libraries now work on all accesses not only \*RUN. This allows you to have a utility directory with all your commonly used programs without muddling in your current workfiles. Very useful for BCPL User.

- Programs can now reside lower in memory reclaiming some of the DFS' workspaces, indeed PAGE can be taken as low as £1100 under most circumstances.

- To make DFS easy to use, wild cards ("\*") have been made vastly powerful, e.g. \*INFO \*A gives information on all files in the current directory which have an "A" anywhere at all in their filename.

- Comprehensive and clearly written Manual (available separately) gives the user a complete package deal.

- Fully compatible with BBC TELETEx and TORCH Systems.

DFS ROM **ONLY £2**  
Complete Disc Interface Kit including DFS ROM and fitting instructions. **£9**  
Comprehensive and clearly written DFS Manual. **£7.50 (No VAT)**

P.S. We will exchange your existing ACORN DFS or PACE (AMCOM) DFS for the highly sophisticated Watford's DFS ROM for **ONLY £2**

Watford's DFS is exclusively available from Watford Electronics. We DO NOT retail through any Dealers.

## WATFORD'S BEEB PRINTER ROM



"Makes Printing Childs Play"

Are you fed up with not being able to unravel your printer manual and use all those features you paid for? Need sensible paging for use in the creation of documents? Then you certainly need our Beeb Printer ROM machine code printer utility in ROM.

'Single' key operations replace control code sequences for underline, font and size selection, paper movement, etc. Up to 30 come pre-defined, without effecting normal fn key usage.

**This rom allows easy control of your printer from 'Within' WORDWISE text. Instead of long escape sequences, you just 'C' a single number to Select, Underline, Print Styles, etc.**

Automatic fanfold page margins. Puts gaps in margins. PRINTed text etc to skip the folds. The gap size alternates to minimise paper wastage when printing binders.

Form feed and related commands, made available on ALL printers. Can also provide a left margin.

User defined characters embedded within text can be printed as on VDU.

★ Commands select option for GP100, STAR, DEC, MX/FX, LP VII/DMP100, DMP200. Operates with Parallel and Serial Printers.

Fully functional with the popular WORDWISE wordprocessor.

Supplied complete with a comprehensive 50 page manual.

**Price: £24**

(When ordering, please specify printer type)

## NEW LAUNCH DUMPOUT 3

Highly sophisticated machine code ROM providing screen to printer dumps in any mode, as well as window setting utilities and two new 'WORD' calls that allow you to use the Beeb graphic coordinate system for plotting or testing code 7 'pixels'.

IMAGE Ultra sophisticated dump of any graphic screen, using up to 8 tones. Includes **FULL MODE 7 text**, graphics, double-height and colour and mode 8. 14 optional parameters, using 'prefixing' so that you only need specify the ones that you want. The parameters include:

V<scale>, H<scale>. These are both 2 byte numbers giving you very fine control over the dump size from minute to enormous. Unlike other dump Roms, scale does not vary with screen mode.

R<0-3> Dump rotation 0, 90, 180, 270 degrees.

I<indent> Set gap from left edge of paper. X<min><max>, Y<min><max>. The area of the screen dumped is that in the graphics window, alternatively these parameters may be given.

P Physical colour values used for dumping, otherwise use a negative scale, i.e. white prints darkest.)

T Two tone dumps for higher resolution.

M<mask> 8 bits controlling colour masking.

E Contrast expansion. Makes mode 7 text characters and separated graphics stand out more clearly from the background.

C All mode 7 graphics printed as reduced size dumps.

\*GWINDOW Draws graphic window on screen, its size and position can then be altered using the cursor keys.

\*TIMAGE<indent> Does a fast, text only dump of the text window in any mode.

\*TWINDOW As GWINDOW but for text.

DUMPOUT 3 gives you ALL of the GIMAGE facilities listed above and GWINDOW in mode 7 as well, not just hi-res modes.

Deal for CP80, GP80, DP100, GP250, STAR, AGA/TAXAN, NEC, SHINWA, CP80, GEMINI, EPSON MX/RX/FX, LPVII.

MP100/120/200/400 Printers.

Comprehensive Manual included. **Only: £19**

# WATFORD JOINS THE COMMUNICATION REVOLUTION MODEM 84

APPROVED for use with telecommunication systems run by British Telecom in accordance with the conditions in the instructions for use.



## NEW SUPER PRESTEL INTERFACE ROM

Fully compatible with Watford's MODEM 84 as well as with PRISM and most other Modems.

- Supports full Prestel Colour Alpha and Graphic Characters including Double Height, Flashing, Conceal/Reveal.
- Called by simple \*PRESTEL command. Disc and Tape configurations fully supported.
- Telesoftware downloader included.
- Comprehensive MAILBOX facilities including offline editor.
- Auto Logon sequence, can be burnt into ROM if desired.
- Unique "TAG" facility allows tagging and recall of interesting pages - avoids the common and annoying 'NOW WHERE WAS THAT PAGE' problem.
- Page load and save to tape or disc. Pages are automatically saved under Page Number reference in a 'FRAME' directory.
- Print page options are ASCII only (i.e. with suppression of Graphics) - fast and works with any printer - as well as a full graphics dump for the popular Epson printer.
- 'USER' function call built into interface with specialist add-on routines (your own as well as ours).
- All the above facilities available from Function Keys. An overlay is provided giving simple yet comprehensive guidance to the key functions.
- Comprehensive instruction manual supplied.

### PRICES:

**SOFTWARE ROM incl. Comprehensive Manual ONLY: £20**  
**MODEM 84 (without software) £62**  
**MODEM 84, SOFTWARE ROM and Operating Manual £75 (£2 carr.)**

(Please allow upto 28 days for delivery)

Coming soon:

BEEB User to User ROM. For automatic User to User communication including file/program transfer.

Please write to Watford Electronics for full details, Order and Application Forms.

With the launch of Watford's MODEM 84 you can now hook into PRESTEL, MICRONET, HOMELINK, TELECOM GOLD, etc., for about the cost of a good tape recorder. Prestel gives you access to an incomparable database covering almost every subject under the Sun. There is Micronet with lots of free programs that you can download and run. Details of Clubs and User groups, a diary of meetings and exhibitions, news and reviews, technical information, etc. There is Homelink with On-line banking. And there is armchair shopping, travel information, Entertainment, World News, Sports News, Business News, Weather information, Electronic mail and lots more. The basic Prestel subscription is only £5 per quarter for domestic user and at off-peak times there is no charge for access time. Can you afford not to be part of this revolution?

Now using the latest techniques and the new generation of Modem chips, Watford have developed a Modem that is newer, better and yet cheaper than any on the market.

Compare the Specifications:

## MODEM

- Direct-connect Modem using BT approved isolation components.
- Full Duplex V23 operation for Prestel and TELECOM GOLD operation (1200/75 Baud).
- User-to-User half duplex 1200/1200 Baud operation with AUTOMATIC SEND/RECEIVE switch (BEWARE - most MODEMS switch manually between send and receive, which precludes the use of intelligent user-to-user software).
- Simple single button operation and comprehensive LED status display.
- Attractively finished. Sized to sit on the Disc drive.

## NEW FX80 PRINTER DRIVER for VIEW

Do you want to use Italics or Enlarged Characters with View? French or German Characters? These and other FONTS from FX80 character sets can be accessed using our Printer Driver with VIEW. The disc contains an example as well shows how to use. Available on 40 or 80 track Disc. **ONLY: £7.50**

## EPSON DUMP ROM

A specially designed Dump ROM for EPSON RX, FX and the new Kaga KP810 Printers. Will accurately DUMP all Screen modes including TELETXT, GRAPHICS and DOUBLE HEIGHT. MULTITONE DUMPS are also supported. Simple single command (\*SCDUMP) operation.

**Only: £16**

**TINY PASCAL for BBC Micro £59**

## VIEW

Acorn soft's Wordprocessor ROM. **£52**

## FORTH ROM for BBC

This superb (FIG FORTH) compiling language now available in ROM. Simply plugs into one of the ROM Sockets. Manual included. **£33**

# WATFORD ELECTRONICS

Continued →

## BOOKS (No VAT on Books)

30 Programs - BBC Micro .....	£3.25
30 Hour BASIC (BBC Micro) .....	£6.95
35 Education Programs for BBC .....	£6.95
36 Challenging Games for BBC .....	£5.95
40 Educational Programs for BBC .....	£5.95
100 Programs for BBC Micro .....	£6.95
Cassette version of above .....	£10.00
6502 Application Book .....	£11.95
6502 Assembly Language Program ..	£13.95
6502 Assembly Language Subroutines .....	£14.25
6502 Machine Code for Beginners .....	£5.95
6502 Software Design .....	£10.50
A young persons guide to BBC Basic ...	£4.50
Advanced Machine Code Technique for BBC .....	£7.95
<b>Advanced User Guide for BBC Micro</b> .....	£12.50
Advanced 6502 Interfacing .....	£10.95
Advanced 6502 Programming .....	£12.45
Assembly Language Programming on BBC Micro .....	£7.95
Advanced Programming Techniques for the BBC Micro .....	£7.95
BBC Basic .....	£7.95
Assembly Lang. Prog. on BBC .....	£7.40
BBC BASIC .....	£5.95
BBC Basic for Beginners .....	£6.95
BBC Forth .....	£7.50
BBC Lisp .....	£7.50
BBC Micro An Expert Guide .....	£6.95
BBC Micro Book BASIC Sound & Graphics .....	£7.95
BBC Micro Graphics and Sound .....	£6.95
BBC Micro Programs in Basic .....	£5.95
BBC Micro <b>ROM PAGING</b> System Explained .....	£2.95
BBC Micro Revealed .....	£6.95
BBC Micro Assembly Lang. Prog. ....	£7.95
BBC Micro Disc Companion .....	£7.95
BBC Micro in Education .....	£6.50
Basic Programming on BBC Micro .....	£5.95
Creating Adventure Programs on BBC Micros .....	£6.95
Creative Graphics Cassette (Acornsoft). Has 36 graphics programs .....	£8.95
Creative graphics on BBC Micro .....	£7.50
Complete Programmer for BBC .....	£5.95
<b>DISC FILING SYSTEM (DFS)</b> <b>Operating Manual for BBC</b> .....	£7.50
Discover BBC Machine Code .....	£6.95
Discover FORTH .....	£13.95
DIY Robotics & Sensors with BBC .....	£6.95
Further Prog. for BBC Micro .....	£5.95
FORTH Programming .....	£14.40
Functional Forth for the BBC Micro .....	£5.95
Games on your BBC Micro .....	£2.95
Games BBC Computer Can Play .....	£6.95
Graphs & Charts on BBC Micro .....	£7.50
Graphic Art for BBC Computer .....	£5.95
Graphs and Charts (Cassette) .....	£7.50
Graphics on BBC Micro .....	£6.95
Hobbit (Book and Cassette) .....	£14.95
Introducing the BBC Micro .....	£5.95
Introduction to FORTH .....	£9.30
Intro to Micro Beginners Book (3 Ed.) .....	£9.90
Let your BBC teach u to program .....	£6.45
LISP .....	£9.25
Logo Programming .....	£8.95
Mastering VISICALC .....	£12.45
Mastering CP/M .....	£13.65
Micros in the Classroom .....	£4.90
Programming the 6502 .....	£11.95
Programming & Interfacing 6502 ...	£16.00
Programming the BBC Micro .....	£6.95
PASCAL .....	£9.25
Programming for Education on BBC .....	£5.95
Structured Prog. with BBC BASIC .....	£6.50
The Complete FORTH .....	£6.95
The BBC Micro Book, BASIC, SOUND & GRAPHICS .....	£7.40
Using Floppy Discs with BBC Micro .....	£5.95
Using BBC Basic .....	£6.95

ONLY THE BEST AT  
WATFORD

## STOP PRESS

### DOUBLE DENSITY BOARD FOR BBC

We are proud to announce the launch of our Double Density Board for the BBC Micro. The DDFS software that we supply is a version of our highly acclaimed standard 16K DFS for the BBC Micro. It will automatically tell whether a single or double density disc is being accessed, as well as allowing the option of reading 40 track disc on an 80 track drive. Now on your 80 track Double Sided Drive you will have 720K storage instead of the usual 400K and with higher speed than ever before (of course this is a BONUS at NO EXTRA COST). Complete Double Density Upgrade Unit will cost same as single density Kit.

### DATA RECORDER & ACCESSORIES

Top quality Slimline, portable Data Recorder for computer use. Mains/Battery, operated with counter **£24.00**  
**DATA RECORDER CABLE**  
 For our Data Recorder to BBC Micro **£2.50**  
**DATA CASSETTES** Top grade C12 Data  
 Cassettes in library cases. **36p**

### ATTACHE CARRYING CASE for BBC Micro

These Attache Carrying cases are attractively finished in mottled antique brown leatherette. An ideal and very safe way to carry your BBC Microcomputer. Price: **£12 (£2 carr.)**

### ADVANCE USER GUIDE for BBC MICRO

Only: **£12.50** (no VAT)

### VOLTMACE'S DELTA 14 Hand-set

Price: 'Delta 14' Hand set **£12.50**  
 ADAPTOR MODULE **£12.55**  
 TRANSFER PROGRAM **Tape £5.10**  
**Disc £7.95**

### JOYSTICKS for BEEB

Two versions available:  
 SINGLE: Player type **£7.00** each  
 TWO Players type **£12.00** per pair

Prices subject to change without notice.

MAIL ORDER AND RETAIL SHOP. TRADE AND EXPORT INQUIRIES WELCOME.  
 GOVERNMENT AND EDUCATIONAL ESTABLISHMENTS OFFICIAL ORDERS ACCEPTED.  
 CARRIAGE: Unless stated otherwise, please add 75p to all cash orders.

VAT: UK customers please add 15% VAT to the total cost incl. Carriage.

SHOP HOURS: 9.00am to 6.00pm. Monday to Saturday. (Ample Free Car Parking Spaces)  
 ACCESS ORDERS: Simply phone: Watford (0923) 50234. (24 Hours)

## PLINTH FOR BBC MICRO

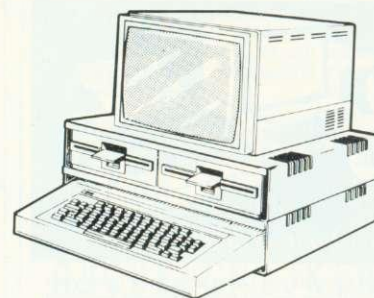

Protect your micro from the weight of the heavy TV/Monitor. This sturdy plinth is attractively finished in BBC colour. Air vent slots have been provided to allow maximum air circulation. It can be used to support a monitor or a printer. The micro slides underneath comfortably. A must for every BBC Micro owner, specially for those who have to move/open their computer frequently.

Single Decker **£11** (carr. £1.50)  
 Double Decker **£20** (carr. £2.00)

## PLINTH FOR PRINTERS

Keeps your desk tidy. Place the printer on the plinth and the paper underneath. Finished in BBC colour.

**£10** (carr. £1.50)

## 4 WAY MAINS DISTRIBUTION SOCKET

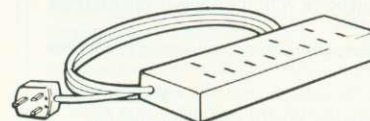

A highly versatile space saving solution when multi-power outlets are required. Can be wall or floor mounted. Ideal for Micro Computer and peripherals application. Prevents you getting a dangerous tangle of plugs and adapters.

Only: **£9.50**

## READY-MADE LEADS

CASSETTE LEADS 7 pin DIN Plug  
 to 5 pin DIN Plug + 1 Jack Plug **£2.00**  
 to 3 pin DIN Plug + 1 Jack Plug **£2.00**  
 to 7 pin DIN Plug **£2.50**  
 to 3 Jack Plugs **£2.00**  
**6 pin DIN to 6 pin DIN Plug (RGB)** **£2.50**  
 Monitor Lead, BNC to PHONO **£3.00**  
 Disc Drive to BBC Micro Power Lead  
 Single: **£3.00** Dual **£3.75**

## MISCELLANEOUS CONNECTORS

	Plugs	Sockets
RGB (6 PIN DIN)	30p	45p
RS423 (5 pin Domino)	40p	50p
Cassette (7 pin DIN)	25p	65p
ECONET (5 pin DIN)	20p	30p
Paddles (15 pin 'D')	110p	215p
BBC Power Plug 6 way	75p	-
Disc Drive Plug 4 way	70p	-

# Watford Electronics

Dept. BBC, Cardiff Road, Watford, Herts, England.  
 Telephone: 0923 40588/37774. Telex: 8956095



## Testing

### the keyboard

HERE is a question that is straightforward enough but the answer leads on to an exploration of some features of BBC Basic that I know confuse many. David Cameron of Bradford understands what INKEY does followed by a positive number in the brackets, but asks for help with the negative INKEY statement. The subject is something the handbook does not explain fully. It is actually quite easy when you know how, but, as is usual with the BBC (and of course the Electron), there's usually a great deal more hidden round the corner!

INKEY (X) where X is a negative number enables you to see whether a particular key is pressed at that instant. This is most useful as it is possible not only to test those keys that have an ASCII number associated with them, such as the numbers or the letters of the alphabet, but it also allows the programmer to test for keys such as the copy key or the shift key which have no ASCII code.

As always, the best way to see how it works is to try a few examples. Listing 1 (see page ii) uses a REPEAT . . . UNTIL loop to keep testing the keyboard and ends when the space bar is pressed; -99 is the number for the space bar. A full list is given in both the Electron and BBC user guides. What the user guides do not mention is that if the appropriate key is detected, a value of -1 will be stored in A, and a value of 0 if the key is not detected. Those who intend writing programs on their BBC for the Electron beware! Some of the negative INKEYs do not exist on the Electron. The Electron has no TAB key, no SHIFT LOCK, and negative INKEY cannot be used to detect the Electron's function keys. Neither can the following be detected in this way on the Electron: ^, \, @, [, ].

When listing 1 is run, if several keys are pressed before the space bar is pressed the string of characters will be printed when the program ends. To avoid this, include line 80:

```
80 *FX15,0
```

This will clear the keyboard buffer, where key presses are stored temporarily before being processed by the computer. Listing 2 is a rearranged version of listing 1. This saves having to use a variable (A) and saves a line of typing, and hence some memory space.

Listing 3 shows how INKEY works with a positive number in the brackets. The positive number represents the number of centiseconds (hundredths of seconds) the statement will wait for a keyboard response. In the case of listing 3 it will wait three seconds. If no response is made in the time allowed, a value of -1 is returned in the variable A. If a key is pressed, then the ASCII number of that character is returned. There is a list of ASCII numbers in both user guides. These are not the same values as the negative INKEY numbers (couldn't be that easy). The ASCII number for the space is 32. Using INKEY in this way is a useful way of creating a pause in a program.

Listing 4 shows another variation on the 'testing the keyboard for the space bar' theme. This program uses the GET statement, which will halt the program until a key is pressed. Listing 5 is very similar, except that GET\$ is used. GET returns an ASCII number corresponding to the key that was pressed, GET\$ returns the ASCII character itself.

Finally, listings 6 and 7 are procedures to print a message at the bottom of the screen in reverse text and wait until the space bar is pressed. Two versions are needed, one for modes 1 and 4 and the other for modes 2 and 5. A third version would also be needed for mode 0, but has not been included here. The reason for the different versions is the differing size of print between the modes. The long strings of VDU codes in listing 6 have the following meaning:

*VDU 24,175;10;1100;60;* Define a graphics window at the bottom of the screen.

*VDU 5* Join the text and graphics cursors.

*VDU 18,0,131* Define graphics colour (GCOLOR,131). In this case the background colour. White in modes 1, 4 and 5, yellow in mode 2.

*VDU 12* Clear the graphics window to the colour just defined.

*VDU 18,0,0,* Define black as the text colour.

*VDU 18,0,128* Set background colour back to black.

*VDU 18,0,3* Set text colour to be white in modes 1, 4 and 5, and yellow in mode 2.

*VDU 16* Clear graphics area.

*VDU 4* Separate text and graphics cursors.

*VDU 26* Restore default windows.

Lines 10030 and 10040 need not be two separate lines. They were split to make the procedure more readable.

## To rewind or

## not to rewind

BOB BARRETT of Belfast says he was horrified to read my advice about not rewinding cassette tapes after use (*Acorn User*, February). This, he says, could lead to cassette tapes becoming slack and then when re-used winding themselves round the cassette mechanism and being destroyed.

I stand by my advice. The problem of tape winding itself around the spindle of the cassette recorder is much reduced with the use of short-length computer tapes. In fact I can't remember it happening, although it often happens with the long C90 audio tapes. My main reasons for suggesting that the tape is not rewound is that I have

**IF YOU have a technical hitch or a programming problem let Martin Phillips give his diagnosis. We'll pay £5 if you raise a really interesting point. Please give full details of the system you're using and include a listing where appropriate, making your question as specific as possible. WRITE TO: Hints & Tips, Acorn User, Redwood Publishing, 68 Long Acre, London WC2E 9JH.**

# A STAR IS BORN



## PRESTEL, MICRONET, BBC to BBC file transfer, Terminal Emulation.

Commstar is unique and complete, a total solution. Imagine, a single Eprom-based package of sophisticated communications software that caters for all your requirements.

### Imagine Commstar

Take for example British Telecom's Prestel service offering access to a multitude of up-to-the-minute information pages, world news or weather and much more. Instant access to Micronet 800 with many free programs that can be downloaded in seconds, free advice and news. Expand your horizons and find out just how versatile our computer can really be! How many times have you wanted to get a copy of a program to a friend or a business colleague, quickly? With Commstar you can transfer a file of ANY type, between two BBC's (which may be thousands of miles apart), in the space of a phone call.

It really is that simple!

Commstar is 'intelligent'. It offers many advanced features to ensure simple and effective communication with the remote system.

Consider the following features.

### Prestel Mode

Prestel mode features full colour Prestel graphics including double height and flashing characters. Full Telesoftware capability is offered allowing the many free programs offered by Micronet 800 to be downloaded into your computer. Pages of particular interest may be 'marked' for later retrieval and display. Page images may be copied and saved to a file on the current filing system.

### Terminal Mode

In terminal mode all input may be copied into a buffer in memory or spooled directly on to disc. Full control over buffered data is provided allowing it to be listed to screen or printer, sent to the RS423, saved to or loaded from the current filing system (including TAPE).

Commstar allows full configuration and easy control over the protocols used. Send and receive baud rates, word length, parity and number of stop bits are selected from a simple table of options.

When in chat mode (80 or 40 column), characters transmitted by the host will be displayed on the BBC screen and characters typed on the BBC will be sent to the host.

Commstar allows ANY type of file (not just ASCII) to be transferred 'safely' using XMODEM protocols. In fact, four individual methods of transmission are provided for within Commstar giving great flexibility.

Using a disk based 'emulation' file, Commstar can be configured to emulate virtually any terminal type including VT100, within the capabilities of the BBC.

In addition to the above, most MOS commands can be executed from within Commstar, errors are trapped by Commstar's own error-handling routines and an optional elapsed time clock may be displayed. Data filter, Local Echo, Auto-line-feed, printer on/off and XON/XOFF protocols may be toggled in or out by a single key press, extensive use being made of the function keys.

Finally, Commstar may be fitted into any of the sideways ROM sockets and is provided with a comprehensive manual.

£34 inc. VAT & Carriage.

## A revolutionary new approach to program development aids.

Toolstar is a powerful new utility Rom that will open up a whole new world for BBC micro users. Toolstar adopts a revolutionary new approach to program development aids. It has been designed specifically to assist both Basic and Machine code programmers by providing an integrated set of powerful building blocks which rapidly become an indispensable complement to the built in facilities of your BBC micro.

This package contains the Toolstar firmware in Eprom and a very comprehensive manual (over 150 pages), containing many examples and illustrations to help you make the best use of Toolstar's exciting capabilities.

### Toolstar sheds new light on your BBC micro

Toolstar, being Eprom-based will be permanently resident in your computer allowing all of its commands to be immediately available. It is 'transparent' to both the user and the operating system; once a command has been executed, control is returned to Basic, or whichever ROM had control prior to the command.

Full error handling has been incorporated and for new users there are full help menus describing each command and its syntax.

### Powerful building blocks for Basic programmers?

Within Toolstar there are 22 commands, 8 of which operate between PAGE and TOP i.e. on the current Basic program or Basic programming environment. These commands obey standard Basic command syntax rules.

### Reveal the deepest secrets of your discs

Toolstar allows the operations of Formatting, Verifying, reading or writing a disc sector to be carried out very simply from Basic i.e. all the necessary building blocks required to develop a comprehensive set of disc utilities, simply and effectively.

### Lost your memory? - No more amnesia with Toolstar!

In addition to the commands described above there are 9 commands which operate on the whole of the BBC's memory and are designed to complement the BBC's built-in assembler. These include a full feature disassembler and memory dump, each with forward and reverse scrolling.

### If this is not enough Toolstar can be Extended!

There are three help menus on Toolstar which may be obtained by typing HELP TOOLS, \*HELP MCODE or \*HELP EXTEND. The third option menu will initially display the following:

\*HELP EXTEND

EXTEND - RAM adds :-

i.e. typing \*EXTEND -address- will allow the user to extend the facilities of Toolstar with routines which are supplied by himself. The manual describes fully how this operation is carried out and illustrates it with several examples.

In the future such utilities will be made available on disc and cassette from Pace, thus allowing a comprehensive library of utility programs to be built-up.

£34.00 inc. VAT & Carriage.

## Access and Barclaycard Dealer Enquiries welcome

Send for more information to:



92, New Cross Street,  
Bradford BD5 8BS.  
Telephone: 0274 729306  
Telex: 51564

frequently seen inexperienced users rewinding the tape by pulling out the connecting lead to make the cassette motor work. This quickly destroys the cassette lead and/or cassette socket. In any case with many programs it is not easy to stop the program, use the \*MOTOR command and rewind the cassette. Not rewinding cassettes has caused no problems for me, but I always use C12 or C15 tapes. Also, if a backup copy is made of tapes, it is cheaper to risk the occasional loss of a cassette than to keep replacing cassette leads.

Mr Barrett also bemoans the fact that there was no \*FX command to alter the inter-block gap on cassette files. Acorn in fact allows this to be changed, not using a \*FX command but the \*OPT3 command. The inter-block gap can be altered from 0.1 to 12.7 seconds on loading. The default value (the value normally set by the computer) is 2.5 seconds. It is not possible to change the inter-block gap using a \*OPT or \*FX call when saving data files. The \*OPT command is mentioned on page 398 of the user guide.

## Tape loading problems

Mr PROVAN of Glasgow has been writing programs on his computer, saving them on tape and then trying to load them on another computer without success. Even using the same cassette player he gets block and data errors. The only way he can transfer programs at 1200 baud is to make a tape copy using a twin tape copier and use that.

The fact that a program loads after it has been copied on a stereo copier suggests that the fault lies in the different record or playback levels expected by each computer. Several circuit changes were made to the cassette interface on early and not-so-early BBCs.

This is a problem for the dealer to sort out. It might be necessary to take both computers in to find which (or both) is incorrect. The dealer should be aware of the changes made on the earlier computers and should be able to modify yours and bring it up to the latest standard.

## A window on printing

J SUMMERS asks for a way of printing text vertically on the screen. There are

several methods, most relying on taking each letter in turn (this can be done using the MID\$ statement) and printing it vertically using the TAB statement, or by using VDU5 to join the text and graphics cursors and then using the MOVE statement to position each letter. There is another, not very obvious, way that is much easier. You define a text window one character wide and print the word inside the window. Each letter will appear under the previous one. The text window can be cancelled using VDU26.

Listing 8 draws two axes and labels each one to show the technique. It will work on both the Electron and the BBC. Line 100 has been inserted to move the prompt and the cursor out of the way when the program ends. The left-hand edge and the right-hand edge of the window have the same value.

On the subject of text windows, I have had several comments from readers unable to define text windows in mode 7 on the BBC. The problem, I suspect, is that the window has been defined too large, so that the window simply defaults to the whole screen. Mode 7 has only 25 lines in common with modes 3 and 6, as opposed to 32 with the other modes. Remember too that it starts at line 0 and ends at line 24, and the first character is positioned at column 0 and the last character at column 39. This has caught me out several times!

A text window one or two characters wide can be defined to have some of the mode 7 control codes embedded. Then if a window is defined as the size of the rest of the screen, the screen can be cleared or scrolled without affecting the control codes.

For some useful effects, try listings 9 to 14. Reference will need to be made to the section on mode 7 control codes in the user guide.

```

10 REM Listing 8
20 MODE 1
30 MOVE 100,1000
40 DRAW 100,100
50 DRAW 1200,100
60 VDU28,0,10,0,1
70 PRINT"Vertical"
80 VDU26
90 PRINTTAB(28,31)
   "Horizontal";
100 PRINTTAB(0,30)
    
```

Listing 8. Demonstrates technique of printing a character within a text window

Listing 9 shows how a title can be placed at the top of the screen and remain there while the rest of the screen scrolls. This effect will work in other modes too, although the double-height facility cannot be used.

## My computer loses its spark

FOR the past two months, writing this feature has been very difficult, and my faith in the Beeb has been shaken. My trusty computer has started letting me down. The troubles started shortly after I fitted a couple of new ROMs onto my sideways ROM board. By now it is beginning to get rather full. When I was using Wordwise the computer suddenly developed a creative spirit of its own and started adding words, phrases and characters here and there.

I found a cure by taking the top cover off the computer. Ah, overheating! I hear wise readers thinking—but no, Listings 9-14 (see also overleaf). Useful effects with text windows in mode 7

```

10 REM listing 9
20 MODE 7
30 FOR N=0 TO 24
40 PRINTTAB(0,N)CHR#131;
50 NEXT N
60 VDU28,1,24,39,0
70 FOR N=1 TO 10
80 PRINT"HELLO"
90 NEXT N
    
```

```

10 REM listing 10
20 MODE 7
30 FOR N=0 TO 24
40 PRINTTAB(0,N)CHR#(130+N MOD 2);
50 NEXT N
60 VDU28,1,24,39,0
70 FOR N=1 TO 10
80 PRINT"HELLO"
90 NEXT N
    
```

```

10 REM listing 11
20 MODE 7
30 FOR N=0 TO 24
40 PRINTTAB(0,N)CHR#(129+N MOD 7);
50 NEXT N
60 VDU28,1,24,39,0
70 FOR N=1 TO 10
80 PRINT"HELLO"
90 NEXT N
    
```

```

10 REM listing 12
20 MODE 7
30 FOR N=0 TO 24
40 PRINTTAB(0,N)CHR#134CHR#141;
50 NEXT N
60 VDU28,2,24,39,0
70 FOR N=1 TO 10
80 PRINT"HELLO"
90 NEXT N
    
```

```

10 REM listing 13
20 MODE 7
30 FOR N=0 TO 24
40 PRINTTAB(0,N)CHR#129 CHR#157 CHR#132;
50 NEXT N
60 VDU28,3,24,39,0
70 FOR N=1 TO 10
80 PRINT"HELLO"
90 NEXT N
    
```

```

10 REM Listing 14
20 MODE7
30 FOR N=1 TO 2
40 PRINTTAB(9,N)CHR#141CHR#130;
50 PRINT"EVERLASTING TITLE!"
60 NEXT N
70 VDU28,0,24,39,4
80 REPEAT
90 PRINT""The title will remain even though"
100 PRINT""the rest of the screen will scroll"
110 I=INKEY(100)
120 UNTIL 0
    
```

this fault was there when the computer was first switched on. I thought the trouble was a broken track on the keyboard circuit board because it happened only when I touched certain keys. After much eyestrain I gave up that avenue of thought and concentrated on the sideways ROM board. I wondered if it was, as Joe Telford had found, that the board was not sufficiently buffered and that adding the extra couple of ROMs had caused the fault. I removed these ROMs and a couple more for good measure but the fault was still there, although not so bad. Back to the drawing board.

By then the fault was getting worse. Listings would not print out, odd error messages appeared, programs corrupted for no reason, and even the disc drive refused to work at times. I got my multimeter out and started measuring voltages here and there. I was surprised to find that the output from the power supply was low, 4.80v when it should have been 5v. I checked the power supply connectors on the circuit board. Lo and behold, several of the spade connectors had dry joints where they were soldered to the board. I

resoldered them, the voltage increased to 4.86v and the fault was cured - for a week.

Stronger measures were called for. I committed the sacrilege of soldering the power supply leads directly to the board. The voltage on the board rose to 4.91v, and again the fault disappeared, this time for a couple of hours, but when the computer warmed up the fault reappeared. In went the multimeter probes again, recording voltage on the sideways ROM down to 4.75v. This needed a drastic remedy. I cut off the two pins that carry the power supply from ROM socket to sideways ROM board, wired the power supply direct to the ROM board and added a small electrolytic capacitor. Voltage 4.9v. This cure seems to have worked and my confidence in my trusty Beeb is returning.

If this was the real fault, then it is probably not just buffering problems on the sideways boards but also low supply voltage caused by drawing too much current down tracks never designed to carry such current. This will affect most boards similarly as they become more populated, or as the ROM socket into which they plug works

loose. Also it appears that the fast-on power lead connectors will cause trouble as the computer ages, and soldering might be a cure. However, this is not a tip for the beginner or the newcomer to soldering. It could cause a lot of expensive damage. If in doubt take it to a dealer.

## Loading

### machine code

R P LANE of Chippenham was trying to copy a machine code program onto his BBC micro in the way shown in April's Hints & Tips. All went well until near the end of the program, when the screen started filling up with odd signs and characters.

What happened was that the free memory space in the computer was full and the program continued loading, overwriting the screen area of memory. Assuming the program will load and run on a BBC, I would guess that Mr Lane has got a computer with disc interface or Econet interface. When either or both of these are fitted they reserve some memory for their own use, leaving less for the user. If Mr Lane tried to load a long program in there would not be enough room.

All is not lost. If you are not using disc or Econet the memory space reserved for either of these filing systems can be recovered and used for other purposes. To do this type PAGE=&E00 and press RETURN. This restores the memory as though you had a tape-based computer. Many programs on cassette check to see if PAGE is different, and change it back again so that when running the program it will load and run without problem.

Some cassette programs that do not check the value of PAGE will not load on machines with disc or Econet fitted and again will work only if PAGE is altered as above. PAGE is the position in memory where a program is to start loading. By altering PAGE it is possible to load two or more programs into the computer (provided they are reasonably short) and quickly switch from one to the other. For example, type PAGE=&E00 and enter a short program and check that it runs (one or two lines is sufficient to play with). Now type PAGE=&3000 and type in another short program and run that. Return to the original PAGE by typing PAGE=&E00 and you should be able to run the original program. On returning to PAGE=&3000 you will still find your second program in residence and this can also be run again.





# ACORN AND MIRRORSOFT WEEK AT LION HOUSE

**£20,000 worth of prizes!**

Lion Microcomputers announce the opening of the Largest Acorn centre in Europe. To celebrate the occasion, a week long promotion from July 9th-15th inclusive will be held at Lion House. A total of £20,000 worth of prizes and special discounts will be given away (prize draws will be daily throughout the week). Lion House will be open every day, including Sunday 15th, until 8.30pm. Admittance after 6pm and on Sunday 15th will be by ticket only. Users of our special £10 discount coupon will receive, by return, two admittance tickets and two raffle tickets which will be entered in each days prize draw. Schools and education authorities on application, will be allocated tickets and times of attendance.

## ACORN

Acorn are moving their Olympia exhibit to Lion House for the week. It will be fully staffed by Acorn and Lion House support, sales and servicing. On view will be Acorn's Formula 3 racing car together with 1st driver David Hunt who will make the draw for prizes, together with other celebrities.

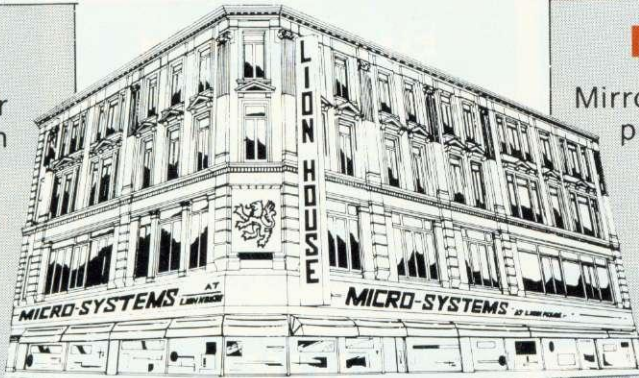

## MIRRORSOFT

Mirrorsoft will give the first public demonstration of their revolutionary astronomy programs: *Starseeker* and *Solar Systems*, published in association with The London Planetarium.

## THE WINDOW FOR THE COMPUTER INDUSTRY

**FREE!** An Acorn Data Recorder and five assorted Acorn soft cassettes with every BBC 'B' purchase

Lion Micro Computers Limited is one of the oldest established retail and business outlets for micros in the U.K. We have built up an unrivalled reputation, for service and support.

We are *not* a chemist shop.  
We are *not* a newsagent  
We do *not* just sell boxes  
We *do* provide a complete service for our customers.

## JUST ARRIVED! ACORN Z80 SECOND PROCESSOR

Turns the BBC Computer into a business system. The Z80 will run CP/M, which has become the standard operating system for running business programs.

Z80 2nd Processor comes complete with free software programs:  
Word processing, filing, financial modelling and three programming languages: BBC, Mallard Basic, CIS Cobol.

Complete Package:  
**£299.00**

+ £3.50 p.p.

**£20,000  
worth of prizes!  
including:**

- ★ 7 BBC Micros
- ★ 7 Electrons
- ★ Home, Educational and Business Software
- ★ Monitors
- ★ Printers
- ★ Peripherals
- and much more.

# £10 voucher

This voucher is worth £10 when used as part payment for any purchase of £100 or more. Only one voucher may be redeemed per £100 of goods purchased.

**Lion Micro Computers**

Lion House, 227 Tottenham Court Road,  
London W1P 0HX. 01.580 7383.





# ACORN MICROS AT LION HOUSE



## BBC COMPATIBLE PRINTERS AT LION HOUSE

### EPSON

RX80 DOT MATRIX	£286.35 (a)
RX80FT DOT MATRIX	£327.75 (a)
FX80FT DOT MATRIX	£444.66 (a)
SERIAL BOARD	£39.95 (c)
FX80 TRACTOR UNIT	£42.17 (c)

### OTHERS

SANPLE DAISY STEP 2000	£343.95 (a)
SHINWA CP-80	£248.50 (a)
BBC CENTRONICS PRINTER CABLE	£16.95 (d)
BBC SERIAL PRINTER CABLE	£12.95 (d)

### BROTHER

EP44 DOT MATRIX	£246.43 (a)
HR1 DAISYWHEEL	£688.85 (a)
HR5 DOT MATRIX	£182.85 (a)
HR15 DAISYWHEEL	£458.46 (a)
HR25 DAISYWHEEL	£858.66 (a)
HR15 TRACTOR UNIT	£109.25 (a)
HR15 SHEET FEEDER	£253.00 (b)
HR15 KEYBOARD	£172.50 (b)

### JUKI

JUKI 6100 DAISYWHEEL	£429.00 (a)
JUKI TRACTOR UNIT	£117.00 (b)
JUKI SERIAL INTERFACE	£71.00 (b)

### MICROS

BBC MODEL A - 16K RAM	£299.00 (a)
BBC MODEL B - 32K RAM	£399.00 (a)
BBC MODEL BD - 32K RAM, ACORN DISK INTERFACE	£469.00 (a)
ACORN ELECTRON	£199.00 (a)

### ADD-ONS

A-B UPGRADE KIT	£92.00
SINGLE 100K DRIVE	£265.00 (a)
DOUBLE 800K DRIVE	£803.85 (a)
TELETEXT RECEIVER	£225.00 (b)
CASSETTE RECORDER	£29.50 (b)
ECONET INTERFACE	£70.00 (c)
DFS DISK INTERFACE	£97.00
SPEECH INTERFACE	£55.00 (c)
GAMES PADDLES	£13.00
6502 2ND PROCESSOR	£195.00 (b)
Z80 2ND PROCESSOR	£295.00 (b)
BIT STICK	£375.00 (b)
IEEE INTERFACE	£325.00 (b)

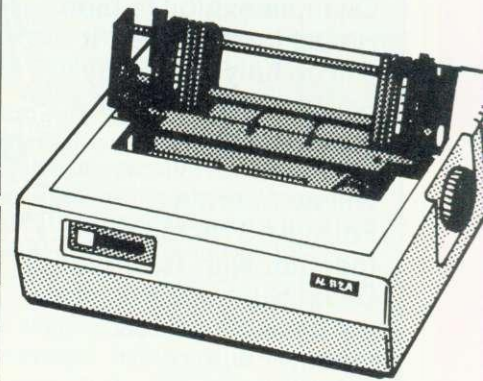

## SOFTWARE AT LION HOUSE

### ROM BASED SOFTWARE

CARETAKER - BASIC UTILITY ROM	£33.35	TOOLSTAR - PROGRAMME DEBUGGING ROM	£34.00
COMMUNICATOR - COMMUNICATIONS ROM	£69.00	TERMI - TERMINAL/MODEM UTILITY ROM	£33.35
COMMSTAR - COMMUNICATIONS ROM	£34.00	VIEW - ACORN WORD PROCESSING PACKAGE	£59.80
DISK DOCTOR - DISK UTILITIES ROM	£33.05	VIEWSHEET - ACORN SPREADSHEET PACKAGE	£59.80
GRAPHICS ROM - UTILITY ROM	£33.35	WORDWISE - WORD PROCESSING PACKAGE	£46.00
(OVER 28 GRAPHIC COMMANDS)		ULTRACALL - SPREADSHEET PACKAGE	£65.00
GREMLIN - MACHINE LANGUAGE MONITOR ROM	£33.35		
PRINTMASTER - EPSON PRINTER UTILITIES ROM	£33.35		

### ACORN BUSINESS SOFTWARE

INVOICING	£24.95	ACCOUNTS PAYABLE	£24.95
ORDER PROCESSING	£24.95	STOCK CONTROL	£24.95
ACCOUNTS RECEIVABLE	£24.95	PURCHASING	£24.95
		MAILING	£24.95

WE ALSO STOCK A FULL RANGE OF OTHER BUSINESS AND GAMES PACKAGES.

# Lion Micro Computers

Lion House, 227 Tottenham Court Road,  
London W1P 0HX. 01.580 7383.



# BBC COMPATIBLE MONITORS AT LION HOUSE



## MONITORS

HANTEREX 9" GREEN/AMBER	£110.00 (a)	KAGA VISION II 12" RGB COLOUR (HIGH RES)	£322.00 (a)
HANTEREX 12" GREEN/AMBER	£117.00 (a)	KAGA VISION III 12" RGB COLOUR (SUPER HIGH RES)	£458.85 (a)
HANTEREX 14" RGB COLOUR MONITOR	£199.50 (a)	MICROVITEC 1431 14" RGB (MED RES)	£228.85 (a)
(SPECIAL LIMITED OFFER)		MICROVITEC 1451 14" RGB (HIGH RES)	£343.85 (a)
KAGA-TAXAN 12" GREEN	£125.00 (a)		
KAGA-TAXAN I EX 12" RGB COLOUR (MED RES)	£247.00 (a)		

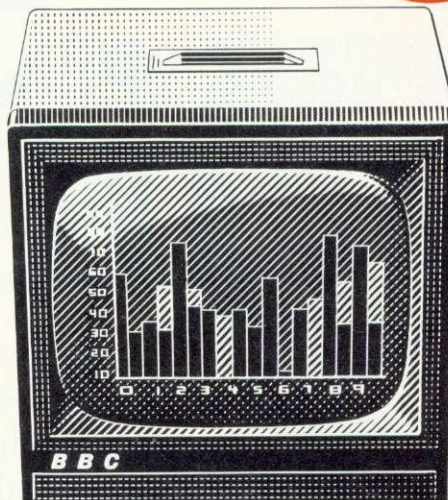

## DISKS AT LION HOUSE

### SCOTCH/CONTROL DATA/DENNISON (BOX OF 10)

SS DD 40T	£24.95 (d)
DS DD 40T	£34.50 (d)
SS DD 80T	£34.50 (d)
DS DD 80T	£41.86 (d)

### DATALIFE

MD525 SS DD 40T	£23.00 (d)
MD550 DS DD 40T	£33.54 (d)
MD577 SS DD 80T	£27.10 (d)
MD557 DS DD 80T (TWIN PACK)	£36.31 (d)
MD525	£ 4.98
MD550	£ 6.94
CLEANING KIT	£ 6.03
10 CLEANING DISKS	£11.54

## BBC COMPATIBLE 5 1/4" DISK DRIVES AT LION HOUSE

### MICROWARE

ZL241BH 40T DS SINGLE 200K	£241.50 (a)
ZL242BH 40T DS DUAL 400K	£438.64 (a)
ZL281BH 80T DS SINGLE 400K	£279.29 (a)
ZL282BH 80T DS DUAL 800K	£517.50 (a)
ZL281BH 40/80T SINGLE 400K	£299.00 (a)
ZL282BH 40/80T DUAL 800K	£537.00 (a)
ZL282BHXX 40/80T EACH DRIVE DUAL 800K	£556.93 (a)

### PACE

PSD1 SS 40T SINGLE 100K	£174.15 (a)
PSD2 DS 40T SINGLE 200K	£428.07 (a)
PSD3 DS 40/80T SINGLE 200/400K	£289.15 (a)
PSD4 DS 80T SINGLE 400K	£257.93 (a)
PDD1 SS 40 DUAL 200K	£345.00 (a)
PDD2 DS 40 DUAL 400K	£483.00 (a)
PDD3 DS 40/80T DUAL 400K	£573.36 (a)
PDD4 DS 80 DUAL 800K	£479.71 (a)
PDD5 SS 40/80T DUAL 200/400K	£501.07 (a)

### CUMANA

CS100 SS 40T SINGLE POWER SUPPLY 100K	£194.35 (a)
---------------------------------------	-------------

### TORCH

TORCH Z80A DISK PACK	£835.00 (a)
TORCH Z80A CELL PROCESSOR	£431.50 (b)

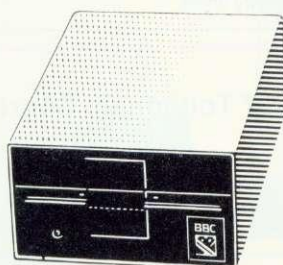

## ACCESSORIES AT LION HOUSE

### BBC ACCESSORIES

PRISM MODEM 1000	£ 69.95 (b)
PRISM COMMUNICATION ROM	£ 19.95
PRISM COMMUNICATION TAPE	£ 14.95
GRAFPAD	£143.75 (b)
RH LIGHTPEN	£ 45.95
VIDEO DIGITISER	£250.00 (b)
DUST COVER	£ 4.50
BBC MONITOR/PRINTER STAND	£ 16.95 (c)
BBC TORCH/MONITOR STAND	£ 24.95 (c)
BANDRIDGE BBC JOYSTICK INTERFACE	£ 11.95

### LEADS

BBC CASSETTE BACLE	£ 3.95
PARALLEL PRINTER CABLE	£16.95 (d)
RS432 - RS232 SERIAL CABLE	£12.95 (d)
VIDEO/MONITOR CABLES	£ 5.95
7-PIN 7-PIN DIN	£ 3.95

### STORAGE BOXES

M35 LOCKABLE 40 DISC STORAGE	£17.25 (d)
M85 LOCKABLE 90 DISC STORAGE	£24.95 (d)
ACCO LOCKABLE 50 DISC STORAGE	£24.75 (d)
FLIP 'N' FILE 15 DISC STORAGE	£ 8.25 (d)

### CLEANING AIDS

AF 5.25 CLEANING KIT	£14.95 (d)
AM KEYBOARD CLEANING KIT	£ 4.31 (d)
AM CASSETTE CLEANING KIT	£ 4.31 (d)
AM SCREEN CLEANING KIT	£ 5.85 (d)

### PRINTER PAPER

9 1/2 x 11 1000 SHEETS	£ 9.00 (c)
9 1/2 x 11 2000 SHEETS	£15.00 (c)
14 1/2 x 11 2000 SHEETS	£19.80 (c)

### SPEECH UNITS

ACORN SPEECH SYNTHESISER	£55.00 (c)
CHEETAH SPEECH BOX	£24.95 (c)





# BOOKS AT LION HOUSE



1 ADVANCED GRAPHICS FOR BBC	£9.95 (a)	31 INTRO. THE BBC MICRO	£5.95 (a)	61 (REP) PROG FOR EDUCATION (BBC)	£5.95 (a)
2 ADVANCED PROG TECHNIQUES BBC	£8.95 (a)	32 LET YOUR BBC MICRO TEACH YOU PROG.	£6.45 (a)	62 ARTIFICIAL INTELLIGENCE	£6.95 (a)
3 ADVANCED USER GUIDE BBC	£12.95 (a)	33 MAKING MUSIC ON THE BBC	£5.95 (a)	63 PRACTICAL PROGS FOR THE BBC	£6.95 (a)
4 A.L.P. FOR THE BBC MICRO (MACMILLAN)	£8.95 (a)	34 PRAC. PROGS FOR BBC/ACORN ATOM	£5.95 (a)	64 BASIC PROGRAMMING FOR THE BBC	£6.95 (a)
5 A.L.P. FOR THE BBC MICRO (ADDISON WESLEY)		35 PROGS. FOR EDUCATION ON BBC	£5.95 (a)	65 21 GAMES FOR THE ELECTRON	£6.95 (a)
6 BASIC PROG BBC MICRO	£7.95 (a)	36 PROGRAMMING THE BBC MICRO	£6.95 (a)	66 40 EDUCATIONAL GAMES FOR THE ELECTRON	
7 BBC BASIC	£6.95 (a)	37 PUTTING YOUR BBC TO WORK	£4.95 (a)		£5.95 (a)
8 BBC BASIC (FOR BEGINNERS)	£5.95 (a)	38 STRUCTURED PROG. WITH BBC	£6.50 (a)	67 THE ELECTRON PROGRAMMER	£5.95 (a)
9 BBC DISK COMPANION	£6.95 (a)	39 USING BBC BASIC	£6.95 (a)	68 ADV M/CODE TECHNIQUES (ELECTRON)	£6.95 (a)
10 BBC GRAPHICS AND SOUND	£7.95 (a)	40 USING FLOPPY DISCS WITH BBC	£9.95 (a)	69 TAKE OFF BBC & ELECTRON	£5.95 (a)
11 BBC IN EDUCATION	£6.95 (a)	41 21 GAMES FOR THE BBC	£5.95 (a)	70 MATHS ON BBC/ELECTRON	£5.95 (a)
12 BBC MICROS EXPERT GUIDE	£6.50 (a)	42 30 HOUR BASIC FOR BBC	£6.95 (a)	71 GRAPHIC ART FOR THE ELECTRON	£5.95 (a)
13 BBC MICRO ASSEMBLY LANG	£7.95 (a)	43 30 PROGS FOR THE BBC MICRO	£3.25 (a)	72 100 PROGS. FOR THE ELECTRON	£6.95 (a)
14 BBC MICRO BOOK SOUND/GRAPHICS	£7.95 (a)	44 35 EDUCATIONAL PROGS FOR BBC	£6.95 (a)	73 BASIC PROGRAMMING FOR THE ELECTRON	£6.95 (a)
15 BBC MICRO FOR BEGINNERS	£6.95 (a)	45 36 CHALLENGING GAMES BBC MICRO	£5.95 (a)	74 ELECTRON M/CODE FOR BEGINNERS	£6.95 (a)
16 BBC REVEALED	£7.95 (a)	46 40 EDUCATIONAL PROGS BBC	£5.95 (a)	75 PROGRAMMING FOR EDUCATION (ELECTRON)	
17 BEST OF PCW SOFTWARE BBC	£5.95 (a)	47 100 PROGS FOR THE BBC	£6.95 (a)		£5.95 (a)
18 BRAIN TEASERS FOR THE BBC/ELECT	£5.95 (a)	48 A.L.P. ON THE BBC MICRO	£7.95 (a)	76 GRAPHS AND CHARTS	£7.50 (a)
19 CREATING ADVENTURE PROGS/BBC	£6.95 (a)	49 A.L.P. PROG ON THE ELECTRON	£7.95 (a)	77 CREATIVE GRAPHICS	£7.50 (a)
20 D.I.Y. ROBOTICS AND SENSORS	£6.95 (a)	50 PROCEDURES & FUNCTIONS IN BBC BASIC	t.b.a.	78 CREATIVE ASSEMBLER	£7.50 (a)
21 DISCOVERING BBC MACHINE CODE	£6.95 (a)	51 CREATING A MICROWORLD ON THE BBC MICRO		79 LISP (MANUAL)	£7.50 (a)
22 DISK SYSTEMS FOR THE BBC	£6.95 (a)		£10.95 (a)	80 FORTH (MANUAL)	£7.50 (a)
23 EASY PROGRAMMING FOR YOUR BBC	£5.95 (a)	52 ELECTRON BOOK SOUND/GRAPHICS	£7.95 (a)	81 BCPL (MANUAL)	£15.00 (a)
24 FUNCTIONAL FORTH BBC	£5.95 (a)	53 ADV. PROG. TECHNIQUES ON ELECTRON	£8.95 (a)	82 S-PASCAL (MANUAL)	N.Y.A.
25 FURTHER PROGRAMMING FOR THE BBC	£5.95 (a)	54 ART OF MICROCOMPUTER GRAPHICS	£12.95 (a)	83 INTO VIEW	£2.50 (a)
26 GAMES BBC COMPUTERS PLAY	£6.95 (a)	55 PROGRAMMING TIPS FOR BBC MICRO	£6.95 (a)	84 VIEW GUIDE	£2.50 (a)
27 GAMES FOR YOUR BBC	£2.95 (a)	56 INTERFACING PROJECTS FOR BBC	£6.95 (a)	85 BEYOND BASIC	£7.25 (a)
28 GRAPHIC ART FOR BBC	£5.95 (a)	57 START PROG WITH ELECTRON	£6.95 (a)	86 FRIENDLY COMPUTER BOOK	£6.95 (a)
29 GRAPHICS ON THE BBC MICRO	£6.95 (a)	58 SOFTWARE FOR THE BBC	£5.95 (a)	87 STRUCTURED PROGRAMMING	£6.50 (a)
30 HOBBIT (BOOK AND CASSETTE)	£14.95 (a)	59 COMPUTING FOR ALL THE FAMILY (BBC)	£6.45 (a)	88 THE COMPUTER BOOK	£5.95 (a)
		60 BBC MICRO PROGS IN BASIC	£5.95 (a)	89 BBC USER GUIDE	£10.00 (a)

## BBC BUSINESS PACKAGES

We have a large selection of business packages, like the new Acornsoft/Merle business software. Available on disk, each package can be linked together to provide a full integrated business system. These modules comprise of invoicing, order processing, stock control, accounts receivable, accounts payable, purchasing, mailing system. Other packages like word-processing (on ROM) spreadsheet packages for handling cash-flow forecasts, balance sheets, price lists, etc. Come in and speak to our experts regarding any business need that you require.

## PLUS

### MONITORS

We have a large range of monitors, starting from amber/green screen hi-res. To high quality RGB colour monitors, sizes ranging from 12" to 14".

### DISK DRIVES

A full range of disk drives starting from 200K memory to 800K memory, 40 and 80 track units, using high quality drives.

## TORCH 280 DISK PACK

Acorn approved CP/M compatible business add-on package, comprising of 2 x 400K disk drives, Z80 processor with 64K memory, complete with "perfect" software: - perfect writer, perfect speller, perfect calc, and perfect file.

## PRINTERS

We have a large range of printers starting from dot-matrix to high quality daisywheels. Dot-matrix capable of producing high quality graphics, daisywheel printers producing letter quality printouts.

To: Lion House Retail Limited, Lion House, 227 Tottenham Court Road, London W1P 0HX.

Please rush me the following:

PRODUCT	UNIT PRICE	QUALITY	TOTAL PRICE

Postage and Packing Rates:

Please add carriage of £1.00 except for items indicated as follows:  
 A) £8.00    B) £8.00    C) 2.50    D) £1.50

TOTAL  
POST & PACKING

I enclose my cheque for £.....  
 made payable to Lion House Retail Limited or debit my Access/Visa/Amex/Diners  
 Card no. ....  
 Name .....  
 Signature .....  
 Address .....  
 ..... Postcode .....

# The pursuit

Alpha Disc Ltd.,  
as a company special-  
ising only in the  
sale and service of  
floppy disc drives and

sub-systems, can  
rightfully claim to produce  
the definative in quality  
disc drive sub-systems  
for your microcomputer.

# of

# excellence.



## FOR EXAMPLE

### OUR MODEL 221 DISC DRIVE ILLUSTRATED HERE, FEATURES:

- A dual unit only 3 inches in height (i.e. the height of your BBC Micro).
- Each disc drive is double-sided 40/80 track switching with a formatted capacity of 400K on the BBC Micro.
- The 221 has a single dual-colour LED on the front panel displaying green 40 track and red for 80 track selection. This we enhance with a two-stage LED illumination to show "power-on" and "drive selected" status.
- As an option, each sub-system is fitted with an on-board switch mode power supply. The efficiency of this unit is such that heat generation is minimal, thus we can construct a secure and safe cabinet ideal for home and educational use.

#### Service and Support:

All our disc drive sub-systems are sold complete with power/data cables, utilities and documentation. Units are covered by a full one year warranty on parts and labour, with service provided direct by Alpha Disc Ltd. A measure of our support is that we will, for a modest charge, service most floppy disc drives supplied by our competitors!!!

For further details on our wide range of quality disc drives and sub-systems send the coupon below, or contact us today at:



## ALPHA DISC LTD

Unit 2, Crabtree Road, Thorpe Industrial Estate, Egham, Surrey  
TW20 8RN. (Tel: 0784 35357/8/9)

Attractive discounts are available to trade customers and educational establishments!

Alpha Disc disc drive sub-systems are also distributed by:  
Chase Data Ltd., P.O. Box 6, Woking, Surrey GU21 4PB.  
RCS Computer Services Ltd., Enterprise House, Central Way, North  
Feltham Trading Estate, Feltham, Middx. TW14 0RX.

Name \_\_\_\_\_

Address \_\_\_\_\_

Telephone \_\_\_\_\_

Area of interest:

078  Education  Trade  Home

# ELECTRON LEARNER

Tessie Revivis starts off our new regular 'welcome pack' section

60

**S**O YOU'VE just opened your Electron box. Great—but what next? Yes, you've taken delivery of the lovely micro you've heard so much about. And there's a funny-looking plug, a black lead of sorts, an introductory cassette and a big book. A quick flick through this *User Guide* looks a bit daunting, with all those diagrams, and you see lots of numbers – and you're no good at maths!

Here's some sound advice from the *Hitchhiker's Guide to the Galaxy*: don't panic! The *User Guide* may look daunting at first sight, but it really is easy to understand, and you don't even need to know the answer to  $2+2$  to read it or program your Electron.

Before getting started, make a bit of room for yourself, preferably on a table with a couple of mains sockets within a few feet of you. You'll also need to commandeer the television set. A spare portable set is preferable, otherwise you'll have to use the family telly, but be diplomatic and let the rest of the family finish watching *Dynasty* first. You'll need to be polite about it because you'll want to use it again in the future. It doesn't matter whether the set is black and white or colour. Colour is nicer to view but black and white performs just as well.

Take your Elk (that's its nickname by the way) from its polystyrene casing. It's light but pretty robust (try not to drop it, though). Place it on the table with the keyboard facing you. This looks very much like a typewriter keyboard, but it has a few extra keys, some of which have odd-looking symbols on them, but we don't need to worry about these yet.

Lay your hands on the keyboard and try pressing a few keys at random. You'll find that you don't have to apply much pressure to depress them. The great thing about programming a computer like the Elk, though, is that you don't have to be a typist.

Look either side of the casing. On the left you'll see four largish round

sockets and on the other side of the case a single small socket. On the underside of the case, directly beneath the set of four sockets you'll see the words 'UHF TV', 'VIDEO', 'RGB' and 'CASSETTE'. These each relate to the function of the socket above. Note the position of the one marked UHF TV – we'll need to connect the TV to this one.

Place the computer in front of the TV set, which should be switched off. To connect the TV to the Elk you'll need the thick black lead supplied. Remove the aerial connection from the TV and plug one end of the black lead into the empty aerial socket. Which end? Well, only one end will fit. The free end can now be plugged into the UHF TV socket that we identified earlier.

Next, we need to connect the Elk to the mains through that odd-looking plug called a power supply. The small round plug at the end of the wire fits into the small single socket on the right-hand side of the Elk. Push the plug end of the power supply into the mains socket and switch on. You should hear a small bleep from the Elk and a small light should be visible on the left-hand side of the keyboard just below the key marked ESCAPE.

Plug the TV in to the mains and

**Above – Power supply lead and Electron-to-television lead. Below – Electron keyboard with 'micro on' indicator light below the ESCAPE key**

switch it on. You'll probably see a poor quality picture of the channel it is presently tuned to. The volume control of the TV can be turned right down, as we don't need sound. To see the picture produced by the Elk the TV must be tuned into the computer's channel. If you have a dial-type channel selector rotate this to about the 35 point; adjust it carefully about this point and you should find the Elk's picture. If your set has a push-button or infra-red channel control you'll need to program one of the buttons. Refer to your TV manual to do this. Again, the channel needs to be set to 35 or 36 and fine-tuned.

Now you're ready to start programming! No, sitting in close proximity to the TV can't give you radiation poisoning, as several old wives' tales suggest. I've been sitting in front of mine for the last year and I've still got three arms! It's a good idea, though, to take a break every half-hour or so to give your eyes a rest.

Try typing a handful of letters on the keyboard. As you press a key it will be displayed on the TV screen. Now press the key marked RETURN, located on the right-hand side of the keyboard. This acts like the typist's carriage return bar, but it also informs the computer that you've finished entering the line and you want it to have a look at what you've typed in. You'll probably



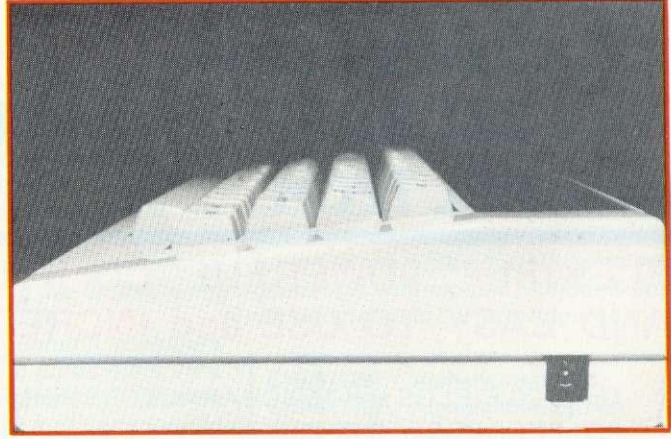
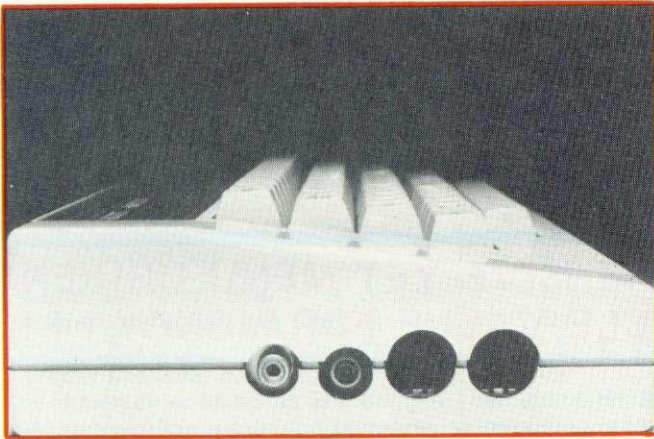

Sideways views of the Electron showing (left) sockets for TV, video monitor, RGB monitor and cassette, and (right) power supply

61

see the word 'Mistake' displayed. The Elk printed this on the screen because it could not act on what you typed in – it was not a valid command.

To get rid of what you typed, push the key marked BREAK at the top right-hand side of the keyboard. Don't be afraid to hit this if you need to wipe the screen clear, you'll do no harm. Try it again and press BREAK a few times.

Type the following in:

VDU7

pressing the keys V,D,U and 7 in that sequence. Now press the RETURN key to 'enter' the letters into the Elk. Did you hear a bleep? If so, you have just entered your first command into the Electron using BBC Basic. This command simply told the Elk to play a short note on its own speaker.

Let's now enter our first program. Type the following in exactly as it appears:

```
10 MODE 5
20 MOVE 1000,0
30 PLOT 85,1000,500
40 VDU 7
```

Remember to press the RETURN key at the end of each line to enter it into the computer. Don't worry about making a mistake – you can't hurt the computer. If you make a mistake simply press the RETURN key and retype the line.

Notice that each line of the program begins with a number. These line-numbers serve the important function of telling the computer the order in which to enter the program into its memory system. Low line numbers come before high line numbers.

Interspersed between the line numbers and each command, and in the middle of some of the commands, are spaces, entered by pressing the space bar on the keyboard, the long key at the bottom. The reason for entering these spaces is to make the program neat and readable. You could leave them out altogether or insert two, or three or more spaces instead of one.

To see the effect of this program we need to tell the Elk to execute each instruction. This is called running the program. Type in the word RUN and press the RETURN key. *Voilà!* You should now see a large white triangle

drawn on the lower half of the screen – and did you hear the beep?

To clear the screen press the BREAK key, as before. To get our short program back we must enter two commands. To remind the computer it has a program in its memory (it does forget sometimes) type OLD and then press the RETURN key. The Elk now recalls the program you entered and will print it on the screen if you type LIST (remember to press the RETURN key). You can now run the program again if you wish.

You might want to re-type it without the spaces to see if they do have any effect on the way the programs operate.

Now you might feel more ready to tackle the *User Guide* and work through the many examples it contains. Start at the beginning and don't skip sections that look a bit overpowering. Programming isn't particularly hard if you try each item out. Try experimenting by changing each program slightly. You won't harm the computer and you can always stop things by pressing the BREAK key.

## CONVERTING BEEB PROGRAMS TO RUN ON THE ELECTRON

**W**HY aren't there more programs for the Electron in *Acorn User*? It's nearly all for the BBC. The Atom gets good coverage. So why not the Electron? This is one of the questions that readers constantly ask *Acorn User*. The fact is that in an average issue perhaps about 75 per cent of the so-called Beeb material will also run on the Electron with little or no conversion. So let's see how all you Elkies can go about the B to E conversion where it needs to be done.

First, it's worth making a list of the main differences between the two

machines so that problem areas can be established. They are:

- No Mode 7 and teletext graphics on Electron.
- No 6845 cathode ray tube controller chip on Electron.
- Only one SOUND channel on Electron.
- Operating system calls.
- No hardware for 'direct' interfacing on Electron.

In most instances the first item on our list will be the only real reason for program surgery.

Look at the program you want to convert. Does it include the command MODE 7? Remember this is the default mode for the Beeb so that even if no mode is specified an initial CLS will have the same effect. Unless the program is specifically about teletext (and is therefore unconvertible), this mode is probably being used to take advantage of double-height and flashing characters for titling purposes. Transferring these into mode 6 should be straightforward. Colour can be achieved effectively using the COLOUR command. page 63 ►

# OPENUP YOUR COMPUTERS POTENTIAL

WITH **BEL BASE** AND **MAILSHOT**  
FROM **BEL TECH**

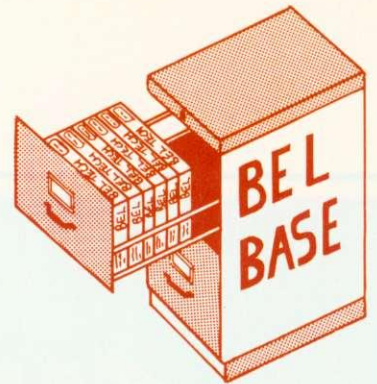

**FLEXIBLE, POWERFUL, COMPREHENSIVE YET MENU DRIVEN AND EASY TO USE and INCREDIBLE VALUE FOR MONEY !!!**

- \* Up to 20 FIELDS and 150 CHARACTERS PER RECORD
- \* 600 RECORDS or 90K Characters per File with truly RANDOM ACCESS Disc Version (15K Characters per File on Tape)
- \* DEFAULT Values can be set
- \* SELECT Disc Drives (0 to 3)
- \* CALCULATION Options. Calculate a Field from the value of others, enter Functions etc. – and change them!
- \* AMEND the Name, Type, Default Value of any Field
- \* SEARCH and REPLACE on all Fields, all Records
- \* SELECTIVE and GLOBAL EDITING of Records
- \* INSERT Records, DELETE a Field or Record
- \* BROWSE Option
- \* FIND (Search on any Field) Print Screen if required
- \* DISPLAY or PRINT Reports (max. 38/137 characters across)
- \* PRINT all Records (2 Fields) or all Data
- \* FORMAT OWN REPORTS (Heading, up to 20 Fields, select, sort etc.)
- \* SORT on any Field (Ascending/Descending) whether Printed or not
- \* SET CONDITIONS (<, >, <=>, =, >=, <=) on any Field, printed or not
- \* SAVE Report Formats to a File
- \* SUM Numeric Fields
- \* SEND Printer Control Characters
- \* COMPREHENSIVE INSTRUCTIONS SUPPLIED



**MAILSHOT IS INCLUDED IN PRICE OF BEL BASE AS A BARGAIN PACKAGE!!**

*PERSONAL USE, BUSINESS, ACCOUNTS, EDUCATION, CLUBS,  
SOCIETIES, FUNCTION, GENERATION  
– JUST KEEP THINKING OF NEW APPLICATIONS!*

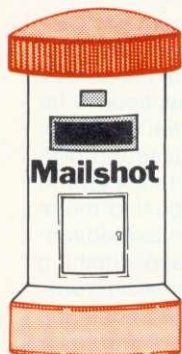

**AND 'MAILSHOT' SEPARATELY:—**

- \* USE AS MINI DATA BASE
- \* Field, Record Size, Amend, Edit, Search, Insert, Replace, Drive Selection, Browse, Find, Sort, Conditions, Printer Control as BEL BASE above.
- + \* LABEL Printing (Std., non std, 1, 2, 3, across)
- + \* PRINT any 6 Fields Across
- + \* PRINT any 6 Fields Down

Order Form	TAPE		DISC		TOTAL
	QTY		QTY		
BEL BASE	16.00		18.00		
BEL GRAPH	15.00		17.00		
BEL CHEM Chemistry 1	9.50		11.50		
Chemistry 2	9.50		11.50		
BEL GEN Geneology	12.50		14.50		
MAIL SHOT	9.50		11.50		

**TOTAL inc. P. & P. £**

NAME \_\_\_\_\_

ADDRESS \_\_\_\_\_

COMPUTER TYPE \_\_\_\_\_ MODEL \_\_\_\_\_

DISC (if applic.) \_\_\_\_\_

CREDIT CARD No PAYMENT BY CHEQUE, P.O. VISA ACCESS

Please Complete & Return to:-

BEL TECH Limited, Stanmore Industrial Estate, Bndgnorth,  
Shropshire. WV15 5HP or

Telephone: 07462 5420 (24 Hrs.)

**FILES ARE COMPATABLE WITH BEL GRAPH**



If the program uses mode 7 it will almost certainly include teletext control codes, which will normally be in the guise of CHR\$ commands. For example, the lines:

```
150 PRINT CHR$ (141): CHR$ (129):
    "Acorn User"
160 PRINT CHR$ (141): CHR$ (129):
    "Acorn User"
```

would print *Acorn User* in red double-height characters on the Beeb's screen. The double-height facility is not directly available on the Elk but could be implemented using the user defined characters. Printing in red is readily performed using COLOUR 1. Figure 1 lists all the teletext control codes that you are likely to encounter.

The fact that we are using the Electron's mode 6 has another side-effect. It uses 6k of memory, as opposed to the 1k required by the Beeb's mode 7. If the program is purely textual, say an adventure game, we have to squeeze it into a smaller memory. For converting programs from *Acorn User* this problem should not arise as listings this long are not normally published in the magazine. However, inefficient programming can drastically increase the amount of workspace below HIMEM required by the program. Consider the Basic lines:

```
10 REPEAT
20 x$=x$+"Ω"
30 y$=y$+"+"
40 UNTIL LEN x$=255
```

The program occupies about 50 bytes but, believe it or not, when run it will require more than 7700 bytes of memory to operate! If running a program ever results in a 'No room' error have a good look through it for this sort of inefficiency.

The Beeb's graphics are handled in a different way from the Elk's. On the Beeb they are controlled by a specialist chip, the 6845 CRTC (cathode ray tube controller), plus a video ULA to provide the colour palette. The 6845 is a memory-mapped device and it is possible to program its registers to achieve rather stunning effects, such as instantaneous screen scrolling, left, right, up or down! The 6845 is not incorporated into the Elk. Instead a ULA chip designed specifically for the Electron combines the BBC's two chips, but it lacks programmability. In other words sideways scrolling is not instantly available.

There is no reason why you should not write your own procedures to perform these functions, but they really need to be in machine code, and even then they would not have the instantaneous effect of the 'hardware' scroll-

ing. For details on the 6845 see the April issue, page 26. To aid your conversion, figure 2 helps you identify the commands the Beeb uses to access the 6845.

SOUND and ENVELOPE are both scaled down on the Elk. Four sound channels are incorporated but the micro can drive only one channel at a time. This means you can't synchronise notes on the Elk using the '&' prefix, eg, SOUND &201, - 15,20,20.

The Envelope command considers only the first eight parameters; the remaining six are ignored. In general there's no reason to make changes to these commands when converting a program, but don't expect a concerto written for the Beeb to adapt readily.

Most of the operating system commands specific to the Beeb's 1.2 MOS have been implemented in the Electron's MOS. However, there are differences between them, although so far Acorn has not released a comprehensive list. Obviously OS calls that refer to items such as analogue to digital converters or the RS423 serial interface are less likely to have been implemented than others. In most instances OS commands will be directly transferable.

Hardware-specific programs will not, of course, run on a bare Electron, but most of the hardware specific commands are implemented in the Electron's Basic - ADVAL, for example.

Because of the Electron's popularity an increasing number of peripherals are becoming available. Sir Computers has been offering a printer and joystick interface for several months and Acorn's own Plus 1 (see the news section in this issue) will be available within a month or two (fingers crossed!). Decide on your printer by reading the reviews by George Hill that have appeared in *Acorn User* over the last year, then take advantage of all of the utilities he has provided.

So, as you can see, it should in many instances be a painless task to do the B to E conversion. A look into the May issue, for example, reveals that the following three programs will run directly

on the Electron with no conversion: *Doodle Bug*, page 83; *The Fantastic Four*, page 96; and *Circles, Diamonds and Squares*, page viii.

*Heaven's Date* (page iii) will run, though you would probably want to convert lines 30 to 100 to look tidy on a mode 6 screen. Similarly, Joe Telford's *Sober Statistician* can be converted to run on a tape-based system as he suggests, and with mode 7 to mode 6 conversion it should perform admirably.

- CHR\$ (129) : Alphanumeric red
- CHR\$ (130) : Alphanumeric green
- CHR\$ (131) : Alphanumeric yellow
- CHR\$ (132) : Alphanumeric blue
- CHR\$ (133) : Alphanumeric magenta
- CHR\$ (134) : Alphanumeric cyan
- CHR\$ (135) : Alphanumeric white
- CHR\$ (136) : Flashing text
- CHR\$ (137) : Steady (non-flashing) characters
- CHR\$ (140) : Normal-height characters
- CHR\$ (141) : Double-height characters
- CHR\$ (145) : Red teletext graphics
- CHR\$ (146) : Green teletext graphics
- CHR\$ (147) : Yellow teletext graphics
- CHR\$ (148) : Blue teletext graphics
- CHR\$ (149) : Magenta teletext graphics
- CHR\$ (150) : Cyan teletext graphics
- CHR\$ (151) : White teletext graphics
- CHR\$ (152) : Conceal display
- CHR\$ (153) : Contiguous graphics
- CHR\$ (154) : Separated graphics
- CHR\$ (156) : Black background
- CHR\$ (157) : New background
- CHR\$ (158) : Hold graphics
- CHR\$ (159) : Release graphics

Figure 1. Teletext control codes

```
VDU 23,0,R,X,0,0,0,0,0,0
  where R = Register
        and X = Value to be written to 6845

&FE00 = Address register
&FE01 = Register file

*FX 151,0,Y = Write Y to address register
*FX 151,1,Y = Write Y to register file
```

Figure 2. 6845 CRTC programming commands



Don't be fooled, these really are BASIC commands, and they can of course use any BASIC variable or expression, be situated in multi-statement lines, be used in line-entry mode, and in fact anywhere or anytime that the standard BBC BASIC commands can be used. No other sideways-ROM offers such facilities, they use 'star commands' that cannot match the ease of use of ADDCOMM's commands.



**Graphics:** SCALE, SMOVE, SDRAW, SPLOT, CIRCLE, ELLIPSE, CFILL, FILL, ROTATE, TRANS, UNSCALE, **Toolkit:** CHAR, FIND, COMPACT, MEM, FKEYS, VERIFY, GOODPROG, KILLREM, GREPL, SREPL, LVAR. **Logo:** ANGLE, LMOVE, PEN, TURN, ADVANCE, LCIRCLE, LELLIPSE, LPOS. **Utilities:** POPFOR, POPGOS, POPREP, LGOTO, OPT, LLIST, SORT, ADDCOMM, WIN, SETWIN, and an extensive \*HELP facility.

Compatible with: Acorn DFS, Amcom DFS, Watford DFS, Disc Doctor, BASIC 1 and 2, Model B with OS 1.20.

# ADD 40 COMMANDS TO BBC BASIC

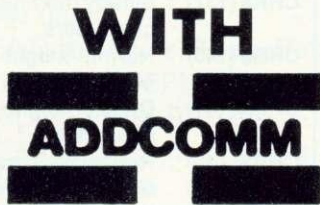

ADDCOMM is as unique as it sounds, and at £28.00 including V.A.T., post and packing and a detailed manual, represents extremely good value for money.

Send cheque/postal order, (or a stamp for detailed brochure) to:-  
VINE MICROS, MARSHBOROUGH, SANDWICH, KENT.  
CT13 0PG

UK's LOWEST PRINTER PRICES !

## PRINTERLAND



ORDERED TODAY - DELIVERED TOMORROW

### DOT-MATRIX

SEIKOSHA GP 50	£120.00
SEIKOSHA GP100	£150.00
EPSON RX 80	£189.95
EPSON RX 80 F/T	£214.00
EPSON RX100	£329.00
EPSON FX 80	£317.00
EPSON FX100	£425.00

### DOT MATRIX PLUS NEAR-LETTER QUALITY

CANON PW1080A	£275.00
---------------	---------

### DAISY-WHEEL

JUKI 6100	£345.00
BROTHER HR15	£349.95
EPSON DX100	£356.00

### ACCESSORIES

WORDWISE	£32.00
PAPER (2000 Sheets)	£12.00
BBC/PRINTER CABLE	£10.95

### COPYALL DISK

● Copies ALL protected disks inc. tape to disk utilities.	
● Best on the market	
● Copies from original to your blank disk	£10.25

Educational, G'ment plus O'seas Orders Welcome  
Please add 15% VAT. Delivery Printers £10.00. Paper £3.00. Other 50p  
Printerland, Unit 27, Estate Buildings, Railway St., Huddersfield HD1 1JP

TEL (0484) 514105

## Gemini

Business Software

**NEW!**

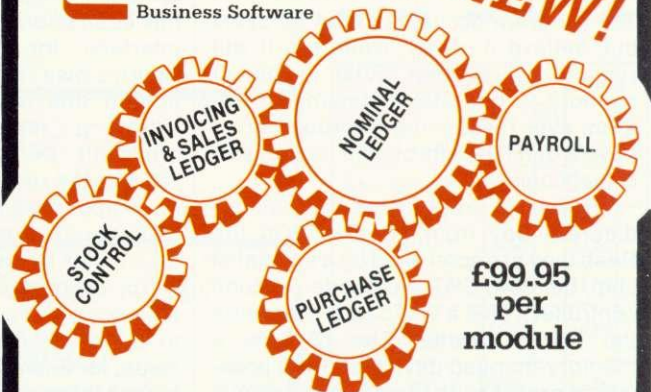

£99.95  
per  
module

### Integrated Accounting Programs for BBC 32K Micro

....Simultaneously and automatically integrates several accounting functions and provides accurate and up to date management information, including Balance Sheets.....all at the touch of a button.

Full, descriptive leaflet available from most good software shops, or direct from:



Gemini Marketing Limited  
18a Littleham Road Exmouth Devon EX8 2QG England  
Telephone (0395) 265165/265832 Telex 42956 Attn Gemini

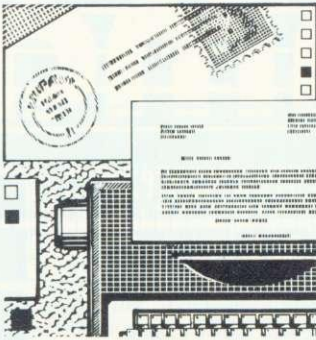

## How Joe

### missed the point

Sir, The idea of a statistics package, as started by Joe Telford in your May 1984 issue, is welcome.

Joe wants to see whether data confirm Bill's hypothesis that in darts games 'men were scoring less on each throw when playing a lady opponent'. He finds the correlation coefficient,  $r$ , showing 'a moderately high correlation of +0.829, apparently proving Bill's theory'. Unfortunately Joe used an inappropriate technique. The correlation doesn't reflect differences between the two measurements in a pair, but only whether they tend to go up or down together in a particular way. Joe shows that for the following four pairs of numbers,  $r=1$ , the biggest it can possibly be:

	X	Y
item a	1	4
item b	2	5
item c	3	6
item d	4	7

If the four items were four men dart players, and X and Y their average scores against lady and men players respectively, it does indeed look as if Bill's hypothesis is supported. But the correlation coefficient would also be 1 with the following results:

	X	Y
item a	1	1
item b	2	2
item c	3	3
item d	4	4

which certainly don't lend credence to Bill's idea.

Commonsensibly, we should look at the differences, average score vs men - average score vs ladies, for each player. Out of eight players, seven scored more against men, which is already evidence favouring Bill. The mean excess of score vs men over score vs ladies is 8.6, with standard error 1.8; this is very strong evidence that Bill is correct.

But of course, as Joe says:

'... A more important question is how valid was the actual data.' For a start, the fact that the two types of opponents are referred to as 'men' and 'ladies', the one not being the natural opposite of the other, leads the reader to suspect that something more than skill at darts is being compared! I hope Joe enjoyed collecting the data.

Wendy Fox  
London

## Horrors of

### statistics

Sir, In your May issue Joe Telford constructed a statistical package for testing the hypothesis that male dart players score less when playing a lady than they do against a male opponent. Now, Joe is a talented chap; his programming skills will already be well-known to your readers but here we find he is also a meticulous field worker in this important area of social research. Unfortunately, all expertise has limits. His breezy adage 'Get the data right and the rest is easy' suggests a serious underestimation of the horrors of statistics. Accordingly, the data were analysed in quite the wrong way for testing his hypothesis.

Each dartsman furnished a pair of scores: a score against lady opponents and a score against other men. With eight players, we had two sets of eight figures to compare. Joe performed a correlation on these data, claiming that the closer the resulting correlation coefficient is to +1 the closer he would be to proving the chauvinistic hypothesis.

Perhaps the easiest way to see that this won't do is to imagine an outcome in which each player happened to score exactly the same in his two games - doing just as well (or badly) against ladies as he did against men. Obviously, the original hypothesis must be wrong here, but it is in just this case that the correlation is perfect at  $r = +1$ . Correlations consider relations between pairs of scores but not the particular relation Joe is after. Scores are 'correlated' across conditions (ie, different opponents) when individuals maintain their relative standing within the whole group. So the high positive correlation for these data means only that the high

scorers against men were also the high scorers against ladies. This is useful information about the consistency of players when judged against each other - it says nothing about the effect of different game conditions on the absolute level of scoring. Nevertheless, I am pleased to say that application of the appropriate test, Students 't', reveals support for the hypothesis.

The rest is still not 'easy', even when we have got the data right and got the analysis right. We must still interpret our findings. I have discussed these results with some of my colleagues and have aroused considerable interest. As Joe is based just down the road from us, perhaps he would be interested in some collaborative research combining expertise. There is a large group of people here unusually anxious to go out and collect more data. I can't understand it.

Dr Charles Crook  
Psychology Department  
University of Durham

We've passed your letter on to Mr Jottings, who will, we're sure, do a statistical analysis on it down at the P&G.

## Deep joy

Sir, I recently bought the new Acornsoft *Aviator* program and must say that it is one of the most impressive simulations around, providing hours of enjoyment.

The program is best appreciated by using a joystick. To my home-brewed joystick I've added a further touch of realism by extending the stick with a two-foot length of plastic pipe half an inch wide and on the end I've mounted a plastic grip like one from a bicycle handle. On the top of this is a small push button wired to the push button on the joystick handset.

When mounted on the floor between your feet the whole thing is a unique experience.

Chocks away!

A Katz  
Edgware,  
Middlesex

## Looking good

Sir, I patiently awaited my May copy of *Acorn User*, which I have only just been able to obtain because it appears to have been published much later than usual. May I say that the new-look magazine is a vast improvement. I am also very glad that we shall be able to obtain tapes of the programs published. I hope that you will be able to topple the other monthly magazine 'Micro User' from its ABC pedestal!

J G Manley  
Rochester, Kent

'Acorn User' should be available in your newsagent on the third Thursday of the month preceding the cover date. For example, this issue came out on the third Thursday of June, ie June 21.

## At last, a new

### wave of games

Sir, A few weeks ago I was seriously considering writing a letter to your magazine in which I was going to complain about the amount and quality of software for the BBC micro. We constantly read articles about 'the fantastic BBC computer' and its 'excellent sound and graphics facilities', and when the BBC was first released Acornsoft provided ten to 20 high-quality programs, most of which were pure arcade copies. But then they sat back and left it at that, and other software houses seemed to follow their lead and not produce any better-than-average programs for six to 12 months. What I want to ask the software houses is, Where are the *Manic Miners* and the *Atic Atacs* of the BBC?

The letter I intended to send was all written out when I received April's issue of *Acorn User*. Upon opening it I found that Acornsoft had released a flight simulator, *Aviator*, Program Power had just released *Ghouls* and *Jet Power Jack* and Superior Software had

ASK a silly question, pass a fair comment, stage an angry protest - we don't mind what you write to us about (or about us!). Keep 'em short, keep 'em sweet, but keep 'em coming! The address is: Letters, Acorn User, Redwood Publishing, 68 Long Acre, London WC2E 9JH.

# Computerama

the source

ROM SOFTWARE	INC VAT
Wordwise	39.95
View	59.00
Printmaster	32.95
Caretaker	32.95
Disc Doctor	32.95
Termi (terminal emulator)	32.95
Graphics Extension	32.95
Acorn Speech System Upgrade	55.00
HCCS Forth	39.95
HCCS Logo Forth	67.85
HCCS Pascal	57.00
HCCS Excel	74.75
ROM Extension Board (ATPL)	
The Best!	43.70

BOOKS	NO VAT
BBC Micro Disc Companion	7.95
Creative Graphics	7.50
Graphs & Charts	7.50
Lisp Manual	7.50
Forth Manual	7.50
BCPL Manual	15.00
Discovering BBC Micro	
Machine Code	6.95
BBC Micro Disk Manual	1.95
Disc Systems For	
The BBC Micro	6.95

PROGRAM POWER	INC VAT
Killer Gorilla	7.95
Cybertron Mission	7.95
Cosmic Combat	7.95
Chess B	7.95
Danger UXB	7.95
Escape Moonbase Alpha	7.95
Felix in Factory	7.95
Felix & Fruit Monsters	7.95
Nemesis	7.95
Bumble Bee	7.95
Wizards Challenge	7.95
Jet Power Jack	7.95
Positron	7.95
Demon Decorator	6.85
Alien Swirl	7.95
Alien Destroyers	7.95
Space Jailor	7.95
Ghous	7.95
Moon Raider	7.95
The Mine	7.95
Hell Driver	7.95
Labyrinths of LaCoshe	7.95
Zarm	7.95

SUPERIOR SOFTWARE	INC VAT
Road Runner	7.95
Hunchback	7.95
Overdrive	7.95
Battletank	7.95
Cosmic Kidnap	7.95
Star Battle	7.95
Moon Mission	7.95
Percy Penguin	7.95
Boris In The Underworld	7.95
Rocky	7.95

OPUS	INC VAT
Dogfight	8.95

BUG-BYTE	INC VAT
Twin Kingdom Valley	7.95

DYNABYTE	INC VAT
Pool	7.95
Horseace	7.95
Lemming Syndrome	7.95
Corporate Climber	7.95

BBC/ACORNSOFT	INC VAT
Algebraic Manipulation	9.95
Business Games	9.95
Castle of Riddles	9.95
Creative Graphics	9.95
Countdown to Doom	9.95
Forth	16.85
Graphs & Charts	9.95
Hopper	9.95
Lisp	16.85
BCPL (Rom + Disc)	99.95
Missile Base	9.95
Meteors	9.95
Kingdom Of Hamil	9.95
Monsters	9.95
Planetoid	9.95
Rocket Raid	9.95
Snooker	9.95
Sphinx Adventure	9.95
Starship Command	9.95
Tree of Knowledge	9.95
Snapper	9.95
Shirley Conran's Magic Garden	9.95
Personal Money Management	9.95
Draughts and Reversi	9.95

ACORNSOFT EDUCATIONAL SOFTWARE NOW AVAILABLE	
White Knight II	11.50
Vutype	16.10
Tax Calc	17.25
Beyond Basic	11.50
Toolbox	21.00
Canyon	10.00
Record Keeper	15.00
Doctor Who	10.00
ACORNSOFT MIRLE NOW IN STOCK	P.O.A.

SOFTWARE INVASION	INC VAT
Eagles Wing	7.95
Spooks and Spiders	7.95
3-D Bomb Alley	7.95
Gunsmoke	7.95
Vortex	7.95
Attack on Alpha Centauri	7.95

VISIONS	INC VAT
Snooker	7.95
Digger	7.95
Daredevil Dennis	7.95

PSION	INC VAT
Saloon Sally	6.95
VuCalc	14.95
VuFile	14.95

MELBOURNE HOUSE	INC VAT
The Hobbit	14.95

MICROBYTE	INC VAT
3D Space Ranger	7.95

DR SOFT	INC VAT
747 Flight Simulator	8.95
Gorph	7.95

## COMPUTERAMA SOLID STATE JOYSTICK INTERFACE

\* with RAPID-FIRE feature

Now a totally new concept in joystick control for your BBC Micro. Simply plug into the analogue port, and connect ANY Atari type joystick for instant joystick control. FREE keyboard conversion programme allows joystick control of keyboard-only games. No memory-conflicts with this one - due to our unique Relocatable Code feature. ORDER TODAY. Only a few available. Demand is bound to be high.

**ONLY £14.95** + 50p Carriage

## EPSON FX80PD

A SUPERB PRINTER AT A SUPERB PRICE



This most popular of HIGH PERFORMANCE dot matrix printers has all the features you could ask for:

- 180 cps. 11 x 9 matrix proportional spacing
- Normal, Elite & Italic Characters
- Traction & Friction Feed 10" Carriage
- Bi-directional Logic Seeking
- Centronics Interface Standard
- Down loadable Character Set User Defined
- Condensed & Double Width Printing
- Super & Subscripts
- Dot Addressable Graphics NOW AT THE AMAZING PRICE OF

**£389** inc. VAT

## TORCH Z80 DISC PACK WITH OVER £1,100 OF SOFTWARE FREE



ORDER TODAY! Get the Z80 version of BBC Basic FREE! (Was £1.25) runs BBC Micro programmes up to twice as fast, gives 32K for graphics AND 64K for Basic programme.

**NOW ONLY £150** inc. VAT Free Carriage UK only

Software includes:

- PERFECT WRITER
- PERFECT SPELLER
- PERFECT CALC
- PERFECT FILE
- TORCH NET

The TORCH Z80 DISC PACK is the most powerful BBC Micro disc upgrade available. It provides 800K of storage plus a Z80 Second Processor running Torch's own CP/M compatible operating system. Clip this ad to your order to receive free 40/80T computer programme.

NEW TORCH Z80 DISC PACK. Add Torch Power to any 80K/160K drives. Complete 2nd Processor AND Free Perfect software worth £1000. **ONLY £343** inc. VAT.

## QUICKSHOT II BBC MICRO JOYSTICK

Now with rapid fire Option and Solid State Interface. Optional Relocatable code feature - means that it WORKS with more games than any other similar joystick. This SELF-CENTERING JOYSTICK works even with keyboard-only programmes. A sensation at the Micro User Show. More fun - reaches the games other joysticks cannot. Limited supplies of this item.

**£9.95** + £1.55 p&p



## GRUNDIG 14" TV/ MONITOR + REMOTE CONTROL

RGB input for a super clear display. The picture now can be seen to be better colour than any other dedicated monitor. ORDER TODAY! We guarantee that you will not be disappointed when you finish computing, just flick the remote, and you have a super quality 14" colour TV - what better way to justify the expense to your wife or girlfriend? Complete with lead for BBC Micro for only

**£209** inc. VAT.

## RING FOR LATEST PRICES, MANY REDUCTIONS EXPECTED

## WE ACCEPT INSTITUTIONAL EDUCATIONAL ORDERS

## ATPL SIDEWISE ROM EXPANSION BOARD

- Full sideways Rom
- Expansion to 16 Roms
- 16K Battery backed CMOS Ram option
- No soldering required to fit sideways
- Plug-in-and-go construction - Mounts neatly inside the BBC Micro
- Full buffering of address and data buses - prevents data bus loading problems associated with unbuffered boards
- Pin 1 of on-board sockets are connected properly - No spurious crashes due to this known fault on BBC Micro. Existing sockets on BBC Micro are usable. All Eprom sockets are accessible without removing sideways.

**ONLY £43.70** + £1.00 carriage

## 24 HOUR DESPATCH ON STOCK ITEMS

## MAIL ORDER No Stamp Required

Post your order today to **COMPUTERAMA** DEPT. AU7, FREEPOST STAFFORD ST16 2BR OR TELEPHONE OUR MAIL ORDER HOT LINE With your ACCESS or VISA number, we will endeavour to despatch immediately - (0785) 41899.

Call in today. Home Computer Centre for the BBC Micro enthusiast. Send large SAE for further details of any product.

**CARRIAGE** Micro's, Monitors, Disc Drives, Printers £8.00, Books £1.00 each, Cassette Decks £2.00. Leads and software 50p/item (£1.50 max)

## 50 MONEY SAVER!

FREE with every order, five pounds worth of moneysaving vouchers.

## HARDWARE CORNER

BBC	INC VAT
ACORN ELECTRON	199.00
BBC Micro Model B	399.00
BBC Micro Model B + Double density DOS	
BBC Micro DiscUpgrade	489.00
BBC Micro A-B Full Upgrade	95.00
BBC Micro Teletext Receiver	225.00
BBC Micro Z80 2nd Processor	T.B.A.
BBC Micro 6502 2nd Processor	T.B.A.
Double Density DOS Upgrade	89.95
Page DFS	39.95

DISC DRIVES	INC VAT
LVL Dual 100K	340.00
Page Single 100K	169.95
Page Single 40/80T D/Sided	282.90
Page Dual 100K	338.00
Page Dual 40/80T D/Sided	573.95
Torch Dual 400K Z80 Disc Pack	799.00
Page 200K 40T D/Sided	243.00
HOBBIT FLOPPY DRIVES	39.95

MONITORS	INC VAT
Microvitec 14" Colour	229.00
Sanyo 14" Colour	269.00
Fidelity 14" Colour Monitor	199.00
Grundig 14" Colour TV/Monitor	309.00
Sanyo 12" Green	89.00
Phoenix 12" Hi-Res Amber	129.85

PRINTERS	INC VAT
Epson RX80	299.00
Epson RX80FT	299.00
Epson FX80	389.00
Epson FX100	569.00
Shirwa CP80	223.00
Riteman	286.00
Juki 6100 Daisywheel	449.00

MISCELLANEOUS	INC VAT
Sanyo DR101 Data Recorder	39.95
Cassette leads - all types	2.80
Computerama Joystick interface	14.95
Quickshot Joystick (FOR BBC MICRO)	19.95
Printer Cable (Parallel) 1.2 m	9.95
BBC Micro Deluxe Cover	5.95
Light Pen	28.95
Data Cassettes 5 x C20/C15	1.95
The Plug Power Filter	14.95

## ORDER A COMPLETE SYSTEM - GET ALL LEADS FREE

CLARES	INC VAT
B-Base	25.00
Replica II (Disc Only)	12.95
Graph Disc	7.95
The Key (Disc Only)	12.95
Shadow/Inspector	7.95
State 40/80T for Discs	

AMCOM	INC VAT
Fortress (C/D)	7.95/11.95
Space Highway	7.95

GEMINI GAMES	INC VAT
Missile Control	9.95
Caterpillar	9.95

GEMINI	INC VAT
Business Combination Packs	
1, 2, 3, 4	P.O.A.
Data Base	19.95

SOFTWARE FOR ALL	INC VAT
Stock Control (C/D)	19.95/29.95
Invoicing/Statements (C/D)	19.95/29.95
Sales/Purchases (C/D)	19.95/29.95

ADVENTURE INTERNATIONAL	INC VAT
Adventureland	9.95
Voodoo Castle	9.95
Secret Mission	9.95
Pirate Adventure	9.95

SOFTSPOT	INC VAT
Transistors Revenge	6.95
Heist	6.95

H. SOFT (WATFORD)	INC VAT
Penguin	7.95

ALLIGATA	INC VAT
Spirite	7.95
Neanderthal Man	7.95
Blogger	7.95

HEWSON	INC VAT
Hathrow Air Traffic Control	7.95

CRL	INC VAT
Test Match	7.95

A&F	INC VAT
Chuckie Egg	7.90
Cylon Attack	7.90
1801 Berts	7.90

AARDARK	INC VAT
Zalaga	6.90

MIRRORSOFT	INC VAT
First Steps With	
The Mr. Men	9.95

MICRODEAL	INC VAT
Air Traffic Control	9.95
Space Shuttle (C/D)	7.95/9.95

MRM SOFTWARE	INC VAT
Q-Man	5.70
Q-Man's Brother	5.70
Diamond Mine	5.70
Guy In The Hat	5.70
3D Munchy	5.70
Castle Assault	5.70

SOFTWARE PROJECTS	INC VAT
Legion	6.95

DIGITAL FANTASIA	INC VAT
Waxworks	9.90
Circus	9.90
Time Machine	9.90

MOSAIC	INC VAT
My Secret File	9.95

OCEAN	INC VAT
Mr. Wimpey	6.90

JOE THE LION	INC VAT
Challenger	7.95

VIRGIN	INC VAT
Microbe	7.95

# Computerama

STAFFORD	STOKE-ON-TRENT	SHREWSBURY
59 Foregate Street Tel: (0785) 41899	11 Market Square Arcade, Hanley Tel: (0782) 268620	13 Castle Gates Tel: (0743) 60528

brought out *Battletank* and *Overdrive*, so it seems that somebody else had noticed the lack of good, new software for the Beeb and had pressed the software houses to get underway again. I wait pensively for the reviews of these new additions.

The letter from 'A Pirate' forced me to comment that software houses are cutting their own throats by charging high prices for their software. If the prices were lower when the software was first released, people would not have the same incentive to copy software, but if prices are dropped now, the pirates will merely take advantage of making even cheaper copies of programs.

I read with great interest the article on the 6502 second processor, and would like to know when the other second processors are to be released. Also, do you know of any plans to release a 32-bit second processor?

David Edmondson  
Whitworth, Lancs

**No doubt by now you've read all about the Z80 in the June issue (page 26). This is, in theory, already available, although your dealer may not stock it until Acorn has cleared its order list. A 32-bit second processor is being planned but no release date has been fixed yet.**

## Steadier for the Star

Sir, With reference to George Hill's ingenious mode 7 screen dump program (*Acorn User*, March), owners of Star printers have undoubtedly found the hard copy produced by this program to be distinctly 'wobbly'. I discovered that the simple and effective remedy is to insert the control code 'ESC 85,1' (in the form VDU1, 27, 1, 85, 1, 1) at line 195. This turns off the Star's bi-directional printing and so results in a much neater and more regular printout (two examples enclosed).

It's a good idea to re-enable the bi-directional printing just before the end of the program, with a 'VDU 1, 27, 1, 85, 1, 0' at line 335.

Keep the great magazine going!  
David C Sheasby  
W Midlands

## Getting the error

### codes right

Sir, In the May edition of *Acorn User* you published a letter from Mr P Hinchliffe at the end of which he made a call for a complete list of error codes and messages. Having looked into this recently I submit the following information that may be of use to him.

To quote the *Advanced User Guide*: 'The BRK instruction forces an interrupt which is interpreted by the operating system as an error. As part of the error handling in Basic the programmer can incorporate an error number and an error message into his code to identify the error. The byte in memory following the BRK instruction should contain the error number. The error message string should follow the error number and must be terminated by a zero byte'.

As the error number is a single byte it is true that there are 256 possible errors and messages. However, Basic uses only 44 and these are listed in the *User Guide* on page 482. 'At line xyz' is not an error, merely additional information that is appended to the error message using the variable ERL to indicate the line in which the error occurred. Furthermore, error number 60 does not exist.

The operating system uses 15 error codes, but not all of these are listed in the *User Guide*. The following nine are not included and in addition I can find no trace of error numbers 217 (header?) and 220 (syntax).

Error number	Message
213	Locked
214	File not found
215	Bad ROM
247	OS 1.20
249	Language?
250	Key in use

251	Bad key
252	Bad address
253	Bad string
254	Bad command

There are three errors with code 0, though I am not sure whether they are valid errors. Their messages are:

Silly  
Remember space  
Line space

As indicated by code 247, the OS error numbers and messages refer to OS 1.20.

David Abbot  
Horsham, Sussex

## Seriously . . .

Sir, I would like to criticise your magazine for not reviewing utility programs and ROMs. Your magazine is full of charts and reviews of the most useless games, but this is not useful to serious programmers.

I have a copy of *MASS* by DDT Software and have been using it for two months. For anybody writing serious machine code it is one of the most useful utility ROMs available. It is a powerful and flexible assembler which brings a quantum leap to machine code programming on the BBC micro.

I hope other readers get the opportunity to judge for themselves by way of a review, soon.

Roddy Maddocks  
Brighton

**We like nothing more than to please, so we hope the ADE ROM review on page 137 is up your street.**

## Confessions of a

### tape copier

Sir, For the last few months I have been reading the letters concerning software piracy with a great deal of interest.

One thing I have noticed is that some people think that every pirate copy of a program means £9.95 less for the software company. This is not a true conception.

I have certain pirate programs in my collection that have been lent to me by other people (and 99 per cent of software users have copies in their collection, as well they know it). I borrow a tape, copy it and return the original but that does not in any way mean that I have conned the software house out of any money. Indeed, of the programs I have copied I would not have purchased at least 95 per cent.

The fact is that too much software of poor quality is being produced with too much clever advertising. Ten pounds for one game is far too much and so many games turn out to be dead boring anyway.

In fact, there are programs of a fair quality around, but it is virtually impossible to tell which is good and which is run-of-the-mill rubbish.

While we are on the subject, your magazine doesn't help the matter by publishing a classified free ad page. For a start, every ad that says 'swap' means, I imagine, swapping copied software.

No, I am not a hardened pirate yet, and I have as many original programs as pirate copies. One third of the programs I have paid for I don't like at all, one third I put up with and the rest I like—the same applies for copies.

It is time software companies made their prices realistic (Acornsoft especially), provided software on disc and not just on tape, stopped lying about their games—and magazines stopped publishing ads from pirates who use the cover of swappers.

By the way, I think your magazine is the only BBC magazine to provide any true professional journalism, and the new layout and format is much better (my old *Acorn User* magazines always fell apart).

B McBain  
Wisborough Green, W Sussex

## 'Proper'

### management

Sir, With reference to your article 'Database Menu Grows' (page 10, *Acorn User*, May) please be advised that my *proper* database manage-

CEEFAX 153 Wed 11 Apr 13:04/01  
**Weather @ eye** Forecast for  
24 hours from  
noon:

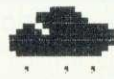

Scotland, N Ireland,  
N Wales and N England  
will have showers and  
sunny periods.



The rest of England and  
Wales will have a little  
rain at first, becoming  
brighter and mainly dry  
with clear periods  
overnight.

Temperatures: Normal in  
south, cold in north.

A neater print-out on Star, by David Sheasby

# StarBASE... a new database

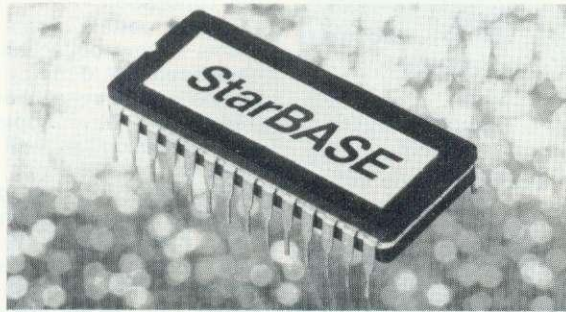

## StarBASE... for the BBC

StarBASE meets and even exceeds professional standards found on large installations. It is unique in speed, flexibility and ease of use.

Price? Only £69.00 inc VAT (plus £1.50 p & p).

STOCK SUBJECT TO PRIOR SALE

Local authority enquiries welcome.  
Prices correct at time of going to press.



GCC (Cambridge) Limited  
66 High Street, Sawston, Cambridge CB2 4BG  
Telephone: Cambridge (0223) 835330/834641  
Telex: 81594 SAWCOM



# Z80 second processor for BBC

## Microcomputer with SAGE integrated accounts program

# £375 + VAT

**diamondsoft**  
A better way of computing

**NEW**

BBC  
i

## Integrated Accounting

Business Software for the BBC microcomputer

The **complete** disc based package:

- Sales / Purchase / Nominal Ledgers
- Cashbook • VAT Accounting
- Full double entry system
- Trial Balance • Age Analyses

**£125**

Requires 40 track disc drive(s)  
and printer.

Please add VAT and send remittance  
(or send for more details) to:

Diamondsoft Ltd., FREEPOST,  
Cheadle Hulme, Cheshire, SK8 5YB Tel: 061-485 8705

**diamondsoft**  
A better way of computing

THE DATABASE SOFTWARE FOR THE BBC  
THAT GROWS WITH YOUR NEEDS

*Beebase II* **£19.95**  
inc.

- Operates on any format DISC or CASSETTE
- Unique TURBOFILE and MAXIFILE options
- HIGH CAPACITY files (up to a full disc with the MAXIFILE option)
- Files created to USER DEFINED format
  - up to 20 items per record
  - each record up to 255 characters
- VIEW file by easy use of cursor keys
- PRINT files (optional report layouts)
- Print LABELS
- Powerful SEARCH features
- SELECT records to view, print, count, total, change or write a file
- SORT file on any item
- Convert TURBOFILE to MAXIFILE (on disc)

Requires BBC 32K (OS 1.0 or later). Optional disc/  
printer. Supplied on cassette – loads to any format  
disc.

Can be supplied on 40 track disc (please add £3)  
Overseas orders please add £2.50 to cover postage.

Cheques or P.O. to Diamondsoft Ltd., FREEPOST,  
Cheadle Hulme, Cheshire SK8 5YB. Tel: 061-485 8705 (24 hrs).

ment system has been on the market since before January.

I say proper because it enables the user to create a whole scheme involving up to 20 or 30 files, which are inter-related. Each file can contain approximately 1800 records and each record 20 fields in up to 512 bytes.

The software (which includes a lot more than the above) is supplied on 80 track disc, with a full manual for £60.

**P S Horner**  
Simon Computer Services  
York

## Legal lists

Sir, I would like to correct a comment in the article about the Data Protection Bill (May edition, page 16).

The writer states that there is no clause excluding home computers. This is not entirely correct as section 33(1) makes specific mention of domestic and other limited use but goes on to qualify the section with sub-sections a,b and sections 33(2-6).

Home computers are used for many purposes, membership/mailling lists for local clubs among them. But if sections 33(2,3) of the Bill become law, it appears to make holding such a list illegal unless the members of the club have been asked individually if they do not object to the information being kept in this way.

In addition, the definition of 'data' as given in section 1(2) could be made, with a stretch of the imagination, to fit Addressograph-type cards which can be put through an automatic label-printing machine, as nowhere in the Bill is the word 'electronic' mentioned!

'Cobbled together' certainly seems to sum up the Bill and if home computer users are not to be caught up in this bureaucracy then some representation should be made to the Home Office to strengthen the existing clause on exclusion of home computer users. Alternatively, leave section 33(1) as it is, alter section 33(2) by deleting the first line, and delete sections 33(3-6).

So, home computer users, get hold of a copy of the Bill (Bill 159, ISBN 0 10 315984 3), digest it and write to your Member of Parliament.

**D S Buckley**  
Harrow,  
Middlesex

## Need help to find your way round the computer scene? Kitty advises you



**Q** I am writing to you for unbiased advice as a total computer novice, and also for assessment of educational software. Living overseas, I have no access to a helpful club or organisation, and I am uncertain as to whom I should address my queries; I don't know of any general or educational computer advisory services in the UK but I am sure they must exist.

We bought, some time ago, a BBC model B computer and it remains virtually unused. We only have the *User Guide* and some magazines to guide us, and we really do not understand it at all.

Please could you recommend a good beginner's guide to computing? I have absolutely no prior knowledge of the subject; I want my computer to be a useful, approachable tool—I will never become a computer fanatic. I want it to enable me to quickly make a start in simple programming and to learn by correcting and expanding them as I go on. It will need to be clearly explained, in detail.

I have seen cassettes for sale which claim to debug programs. Do they work? What, if any, software would you recommend me to buy, to use over the year ahead?

My most urgent requirement is for a large file storage system. Which of all the data storage programs are, firstly, absolutely without errors, and secondly, give me the greatest storage space? Unless, of course, you can recommend me such a simple book that I can write my own program!

In addition to my own needs, my four-year-old son would love to learn to use the computer, and I am unable to guide him. Can you suggest material to teach such a young child about computing? I will be buying material to last a full year.

As a primary teacher, I want to encourage him to learn about computers and also to help his academic progress. Can you recommend any quality, published material, prefer-

ably written by educationalists experienced in teaching this age group, relevant to the needs of early primary children. I am not interested in computerised toy 'sums' and 'spelling' games that have been on the market for several years.

In detail, I am looking for material which covers some of the following concepts, or anything else which is suitable:

Early recognition of numerals and understanding of numbers (ie, 9=9) and that a given number, re-ordered, still totals the given number, obviously leading to addition, but I do not want 'sums' as such. Matching, one-to-one (ie, one cup to one saucer). Anything that encourages logical thought applicable to a 4/5 year old.

Pre-reading material. Left to right orientation (games that make the eye or finger follow across the screen from L to R, and subsequently to form a second line directly under the first). Also hand control/letter formation. Any material available which gives a child patterns or letter shapes to trace over on the screen, giving a reward for accuracy.

Early reading. I really want him to be just learning letter sounds, not names, in the lower, not upper case form.

I apologise for asking you so many questions, and I hope you will be able to answer at least some of them. I feel very out of touch with the computer world and what is going on in the UK.

**Jennifer Booth**  
Abu Dhabi

**A** Where to start? First, clubs and advisory services. Try writing to some of the BBC user groups listed in previous issues; some of them will be happy to answer queries by post (they may have a joining fee, however). Groups that are specifically educational are

MUSE, Freepost, Bromsgrove, Worcs B62 7BR; and the MEP, Chevot House, Coach Lane Campus, Newcastle-upon-Tyne NE7 7XA.

There are several sound books that will introduce you to your BBC and to Basic. I recommend *BBC Basic for Beginners* by David Smith, published by Melbourne House, Melbourne House Castle, Yora House, Castle Yard, Richmond, Surrey TW10 6TS; *Easy Programming for the BBC Micro* by Eric Deeson, published by Shiva, 64 Welsh Row, Nantwich, Cheshire; and *Step-by-Step Programming for the BBC Micro* (books 1 and 2) by Ian Graham, published by Dorling & Kindersley, 1-2 Henrietta Street, London WC2. However, the only way to learn how to write programs is by typing in examples, boring though this is.

Debugging cassettes work only if you understand how to debug anyway—I don't think any of these products would be worth your while, at present.

Now on to databases. You ask about a 'large' storage system. Unless you have disc drives, no storage system can be large; using a database on a cassette system is also extremely time-consuming. You don't say what use you will be putting the database to, but I've found the following to be reliable: *Factfile*, published by Cambridge University Press, Cambridge; and *Masterfile*, by Beebugsoft, PO Box 50, St Albans, Herts. Why not write to these companies and ask what literature they have available?

As for educational software, there are two companies you could write to for their software lists. The first is Bourne Educational Software (BES), Bourne House, The Hundred, Romsey, Hampshire SO5 8BY; the second is ASK, whose products are distributed by Acornsoft, Betjeman House, 104 Hills Road, Cambridge CB2 1LQ. I do feel, though, that learning by computer is no substitute for learning from a person. Also, the best way for a child to learn about computers and computing is just by using a micro.

If you are interested in a fairly simple word processor for your own use, I would recommend Wordwise by Computer Concepts—it is very user-friendly and if you get on with it you can then graduate to more complicated WP software. Computer Concepts' address is 16 Wayside, Chipperfield, Herts WD4 9JJ.



**INTELLIGENT  
INTERFACES**

The UK Distributor of Olympia  
ESW Daisywheel Printers and  
manufacturer of the Acorn  
IEEE Interface

## **ESW COMPACT 2**

The Ideal **Daisywheel Printer/Typewriter**  
For your BBC Microcomputer for **£468 + VAT**



DAISYWHEEL — 100 char. wheel.  
PRINT SPEED — 14 CPS

FORM WIDTH — 14.3"

PRINT LINE — 11.5"

PITCH — 10, 12, 15, CPI

OFF-LINE — FULL CORRECTABLE

ELECTRONIC TYPEWRITER

INTERFACES — CENTRONICS, RS232

PRINTER DRIVER FOR ACORN  
SOFT VIEW AVAILABLE

ON-SITE FIELD MAINTENANCE  
BY OLYMPIA ENGINEERS IN MOST  
PARTS OF THE UK

GENUINE KEYBOARD PRINTER  
NOT AN INTERFACED TYPEWRITER

ALSO FROM INTELLIGENT INTERFACES:-

OFFERING BI-DIRECTIONAL PRINTING, 4K BUFFERS, 17" CARRIAGE  
PROPORTIONAL SPACING AND A LOT MORE. THE REST OF THE ESW RANGE:-

ESW 3000 RO (50 CPS) £1136.00 (15" PRINTING LINE)

ESW 103 KSR (17-24 CPS) £ 998.00 (KEYBOARD)

ESW 102 RO (17-24 CPS) £ 798.00

OPTIONS. TRACTORFEED £ 150.00. SHEETFEED £398! SINGLE DUAL BIN £598!!

ALL COMPATIBLE WITH THE BBC MICROCOMPUTER

**INTELLIGENT: 43B Wood Street, Warks. Tel: 0789 296879—Head Office**

**INTERFACES: Stratford on Avon CV37 6JQ. Tel: 01-311-7981—London area**



# From Intelligent Interfaces Ltd.

DESIGNERS & MANUFACTURERS OF THE ACORN IEEE488 INTERFACE

## THE SYSCON 6

LINKING THE BBC MICROCOMPUTER TO COMMODORE DISK UNITS & PRINTERS

\* Enables Commodore Dual Floppy Disk Units & Printers to be used with the BBC Microcomputer.

\* Supplied with specially written D.F.S. & Printer Driver routines which make the operation of Commodore Peripherals transparent to the user of the BBC Micro.

\* Designed for the 2040, 3040, 4040, 8050 Disk Units & 2022, 2023, 3022, 3023, 4022 & certain other printers

\* Offers commands equivalent to all Acorn Disk Filing System commands Plus additional utilities in ROM e.g. BLOCK which displays contents of specified disk sector on screen and FORMAT etc.

\* **HARDWARE** & Software design of the Syscon 6 makes maximum use of the on board intelligence of Commodore Peripherals

\* Disk filing system and Printer Driver Routines supplied in a 16K by 8 EPROM fitted in one of the BBC computers sideways ROM sockets. Fully supports sequential & random access filing from BBC basic



\* Interface Hardware housed in small plastic enclosure connected to BBC Microcomputer IMH<sub>z</sub> bus & auxiliary power connector.

**NB**  
Standard BBC computer Disk upgrade NOT required.

### FURTHER ADVANTAGES

MORE FILES PER DISK  
LARGER FILES  
INCREASED FLEXIBILITY  
GREATER DATA SECURITY

—FROM 151 WITH 2040 TO 224 WITH 8050  
—FROM 164 KBYTE (4040) TO 256 KBYTE (8050)  
—FILES MAY BE EXTENDED AT ANYTIME  
—BAD BLOCKS IDENTIFIED & EXCLUDED

THE SYSCON 6 IS OF IMMENSE VALUE TO ANYONE WHO USED COMMODORE COMPUTERS IN THE PAST AND NOW USES A BBC MICROCOMPUTER BUT STILL HAS THE COMMODORE PERIPHERALS AVAILABLE.

TO:  
INTELLIGENT INTERFACES  
43 B WOOD STREET,  
STRATFORD-UPON-AVON,  
WARCS CV37 6JQ.



\* ADDITIONAL USER GUIDES AVAILABLE AT £9.50 REFUNDABLE ON PURCHASE OF A SYSCON 6

PLEASE SEND ME.....SYSCON 6 INTERFACES AT £179.40 each INCL. VAT. I ENCLOSE CHEQUE MADE PAYABLE TO: INTELLIGENT INTERFACES.

NAME:

ADDRESS:

# THE PRINTED WORD

## LOW PRICES TOP SERVICE

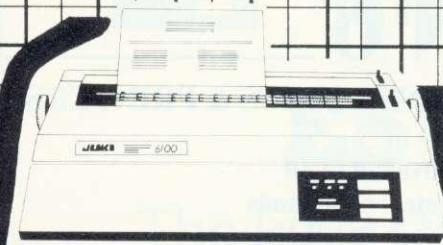

### JUKI 6100

One Year Warranty  
20 CPS : BiDirectional & Logic Seeking  
10, 12, 15 & Proportional Spacing  
Wordstar Compatible  
2K Buffer : 13 Inch Platen  
Underline : Backspace + Lots more  
Centronics Interface Standard  
RS 232 Interface £54.00 + VAT Extra  
Tractor Feed £99.00 + VAT Extra  
Single Sheet Feeder £238.00 + VAT Extra

**JUKI 6100 £365.22 + VAT = £420.00**

**BBC/ORIC or DRAGON Package  
JUKI 6100 + CJE PRINTER PACKAGE  
£440.00 Inc. VAT**



### CANON PW-1080A

#### Near letter Quality Printer

NLQ Mode 23 x 18 Matrix: 27 cps  
Draft Mode 11 x 9 Matrix : 160 cps  
Full range of Epson Print codes  
Friction & Tractor Feed  
Centronics Interface Standard  
CANON PW-1156A (Accepts 15" Paper) Available

**CANON PW-1080A £317.39 + VAT = £365.00  
CANON PW-1156A £391.30 + VAT = £450.00**

**PACKAGE PRICE for BBC MICRO/DRAGON/ORIC  
CANON PW-1080A C.J.E. PRINTER PACKAGE £385.00 Inc. VAT  
CANON PW-1156A C.J.E. PRINTER PACKAGE £470.00 Inc. VAT**

#### Special RS 232 Printer Bargain

STAR DP8480 (8" Printing) £197.00 Inc. VAT  
Ideal for BBC/Newbrain/HX20 & Spectrum Int. 1  
Phone for full specification

C.J.E. Micro's BBC Printer Packs  
For Star, Canon & Juki Printers include:

1. The Printer
2. Delivery by Securicor
3. Cable to the BBC 1.3 Metres
4. Screen Dump Program (M/C Source)
5. Text Dump Program
6. Function Key set up Program. For use with WORDWISE
7. Function Key Label Printing Program. For use with above.
8. VIEW Printer Driver
9. 100 Sheets of Paper
10. Mains Plug with 3 Amp Fuse
11. Booklet giving details of using the printer with a BBC.

C.J.E. Printer Packs for other micro's include:-  
Printer, Cable, Paper, Mains Plug & Delivery



### STAR GEMINI 10X

One Year Warranty  
True Descenders 9 x 9 Matrix  
120 CPS Bidirectional & Logic Seeking  
40, 48, 68, 80, 96, 136 cpl  
Italics, Emphasized, Double strike,  
Super & Sub Scripts  
Downloadable Character Set  
Hi-Resolution & Block Graphics  
Friction or Tractor Feed  
10" x 10" Carriage, 15" x 15" Carriage  
Centronics Interface Standard  
RS232 Int. £52.00 + VAT Extra  
Gemini 10X  
£235.00 Inc. VAT  
Package for BBC/DRAGON/ORIC  
GEMINI 10X + CJE Printer Pack  
£255 Inc VAT  
Star Gemini 15X £390 Inc. VAT

#### STAR DELTA 10

160 CPS CENTRONICS AND  
RS232 INT. STD 8K BUFFER  
£320 + VAT

### BBC MICRO MODEL B £399.00

#### Electron £199.00

BBC Micro Model B with Disc Int. £469.00

Large Range of Accessories including Disc  
Drives, Printers, Monitors always in stock.

#### Printer Cables

BBC to 36 Way Centronics Type Connector £15.00  
Dragon to 36 Way Centronics Type Connector £15.00  
Oric to 36 Way Centronics Type Connector £15.00  
Torch to 36 Way Centronics Type Connector £20.00

#### Serial Printer Cables

BBC to 25 way D type £9.50  
EPSON HX20 to 25 way D type £9.50  
NEWBRAIN to 25 Way D Type £12.00  
25 way D type to 25 way D type £15.00

Blank C15/C30 Cassettes Ten for £4.50 ANY MIX  
Send SAE for Full Price List

### VAT INCLUDED WHERE APPLICABLE PHONE/CREDIT CARD ORDERS WELCOME

Postage 50p per order or as stated  
24 Hr Securicor Delivery  
for Printers/Disk Drives £8.00  
(SHOP/WORKSHOP CLOSED MONDAYS)

### C.J.E. Microcomputers

Dept 78 Brighton Road, Worthing  
W.Sussex BN11 2EN (0903) 213900

**EXPORT ORDERS WELCOME**

**RING FOR SAMPLE PRINTOUT, FULL SPECIFICATIONS & LATEST PRICES  
BEST PRICES & BACKUP ON THE STAR JUKI & CANON PRINTERS**

M I C R O P O W E R M I C R O P O W E R M I C R O P O W E R



# GET ON THE RIGHT TRACK WITH MICRO POWER



Micro Power are an official service and information centre, and we are major suppliers to Government and educational establishments. We stock the complete range of Acornsoft and Micro Power software as well as a wide range of B.B.C. Micro and general computing books. Our expert staff are always on hand to provide advice and assistance in the relaxed atmosphere of our showroom.

## COMPUTERS

B.B.C. Model A	325.00
B.B.C. Model B	399.00
B.B.C. Model B + DFS	469.00
B.B.C. Model B + Econet	446.00
B.B.C. Model B + DFS and Econet	516.00
Acorn Electron (+ 2 free Micro Power tapes)	199.00

**FOUR FREE MICRO POWER CASSETTES WITH EVERY MODEL B**

## MONITORS

Kaga 12" Green Screen	123.05
Ferguson TX Monitor/TV	335.95
Sanyo DM2112 12" Green Screen	74.95
Microvitec 14" RGB/PAL and audio output	258.75
Microvitec monitor (plastic)	286.85
Microvitec monitor (metal)	228.85
Plinth for above	5.75

## DISK DRIVES

Pace 40 track 100K	171.35
Pace 40 track double sided 200K	243.80
Pace 40/80 track double sided 200/400K	282.90
Pace 40 track double drive 200K	388.10
Pace 40 track double sided double drive 400K	483.00
Mitsubishi 40/80 track double sided double drive 400/800K	567.85
Torch Z80 Disk Pack 80 track double sided double drive (including Perfect software)	839.50
AMS HFD 3055 3" 100K	199.00

ALL PRICES INCLUSIVE OF V.A.T.  
We provide free fitting for all firmware.

## PRINTERS

Epson FX80	425.95
Epson RX80 F/T	293.95
Brother HR15 Daisywheel	436.70
Smith Corona TP-1 daisywheel	270.20
MCP 40 4-colour printer/plotter	129.95

## ACCESSORIES

Elftone Digicorder (including leads)	25.95
Acorn BBC cassette recorders (inc. leads)	35.00
Scotch D/S D/D Disks (Box of 10)	32.50
Disk storage cases	19.95
Vinyl dust covers for computers, disk drives, monitors and printers	4.50
Sureshot self centering arcade joystick	18.22
Sureshot self centering double joysticks	34.44
Acorn joysticks	19.00
System Sac	19.95
Printer cables (parallel or serial)	15.50
Stack light pen	28.75
Speech synthesiser plus cartridge socket (Free 1.2 if required)	55.00
Acorn Disk interface (Free 1.2 ROM if req.)	97.00
Pace disk interface kit	95.00
1.2 ROM upgrade	11.50
Econet (Free 1.2 ROM if req.)	70.00
Teletext adaptor (Free 1.2 ROM if req.)	225.00
Wordwise wordprocessor	45.42
Auto Prommers Eprom Programmer	138.00
Tutor Mate shelves	10.50
3M unlabelled Disks (Ten)	15.00
Maxell 3" disk	4.95
First Byte Electron joystick interface (inc. cassette)	24.95
Micro Power potentiometer joystick	12.95
Micro Power double joysticks	18.95

ALL ROADS LEAD TO MICRO POWER!

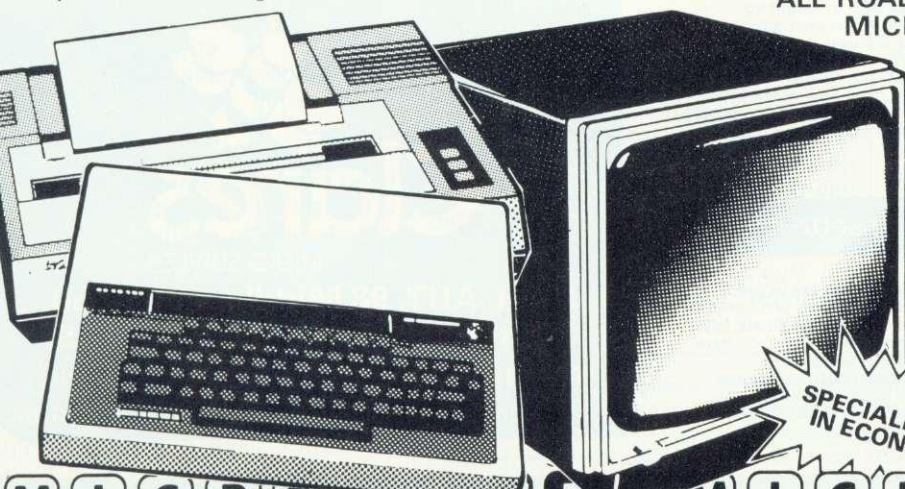

\*HP facilities available. Please contact us for further details.

\*Free parking. All prices correct at time of going to press.



Showroom: MICRO POWER LTD., Northwood House, North Street, Leeds LS7 2AA; Tel: (0532) 458800

Mail Order: MICRO POWER LTD., Sheepscar House, 15, Sheepscar Street South, Leeds LS7 1AD; Tel: (0532) 436300

Send an SAE for our complete listing of hardware, software and books.

**CARRIAGE FREE for ALL hardware**  
Books and software only 55p per order

**SPECIALISTS IN ECONET**

M I C R O P O W E R M I C R O P O W E R M I C R O P O W E R

All disc software now available on 3" disc - add £3.00 to printed prices.

# BBC MICRO COMES OF AGE..

## B-BASE: £25.00

B-BASE is a very powerful and very flexible database program. Because B-BASE is designed specifically for disks there are none of the limitations found in most database programs, which are usually upgraded cassette programs. B-BASE is not limited by memory and even the disk limit can be overcome easily to provide an unlimited file size. Take a look at the features listed below and compare it with so called professional programs at up to £400, we think that you will be amazed. Why limit yourself to a 16K eeprom - B-base contains approx. 30K of tightly compacted code.

Maximum File Size (40 track) - 99k & (80 track) - 199k.  
Maximum Record Size - 2k; Maximum Number of Fields - 200;  
Maximum Field Length - 254 chrs.

Options Include:

- 1) WRITE - for adding records.
- 2) WORK - for displaying records, editing and deleting.
- 3) CALC - allows you to cope easily with fluctuating prices and VAT rates. (works with whole file or search lists). Uses EVAL function allowing complex calculations to be performed, and the results to be displayed on screen or placed in a nominated field.
- 4) SEARCH - multiple function search on up to 5 fields.
- 5) OPTIONS: a) sort records found in search on 3 fields in ascending/descending order (max records sorted is 500).  
b) work search list, with edit and delete.  
c) save records found in search to disc.  
d) load previously saved search list.  
e) make a search list.
- 6) PRINTER - copes with parallel and serial printers and allows you to set up the printout + all printer codes allowed + allows you to join fields together and allows you to set them into columns etc. A label print routine allows single or double labels to be printed.
- 7) REDEFINE - allows you to transfer all records from old file to new file plus add or amend field or record size. No more re-entering all your data if you wish to add a field.
- 8) TRANSFER - allows you to transfer selected records between files.
- 9) NEW - allows you to define new file.  
+ real time clock + many more features.

If you want a professional database for the BBC micro the B-BASE is your only option.

Now compatible with the latest Amcom DFS

## REPLICA II: £12.00

This is the one that everybody has been waiting for. The original REPLICA set a very high standard and many said that it could not be improved. The specification that we set our chief programmer included some supposedly 'impossible' features. In fact ACORN state that some of the things that we have done are impossible, it just took us a little longer that's all. REPLICA II will transfer most of your cassette based programs to disk, even more than REPLICA did. Now when you buy disk drives you do not have to throw away your expensive cassette based programs. REPLICA II will transfer 'LOCKED' programs, programs loading as files, programs that load below &E00, those with up to 6 sections and those up to &6E in length eg adventure programs. No more waiting for 6 minutes whilst your adventure programs load. REPLICA II is very easy to use and the user just enters a name, how many sections and whether CHAIN, \*RUN or \*LOAD is used to load the first section. Press play and let the program do the rest, even a menu. You cannot afford not to have a REPLICA II, think how much it will cost you to buy just 1 disk version of your favourite program - it is probably more than REPLICA II which will hold up to 16 programs, limited only by the disk capacity.

## BEEBSYNTH: disk £11.00 cassette £8.00

A very powerful yet easy to use sound generating program that can be used by expert and novice alike. Up to 16 envelopes can be defined and saved. The envelope definer is very easy to use, control is through the cursor keys, and the effects of your changes can be heard immediately. When you have defined your envelopes press 'K' for Keyboard and the keyboard is transformed into a musical instrument, but you control which instrument. Lets you play chords, not just single notes, change pitch and duration etc etc. A superb program that you can use immediately. Unlimited sounds at your disposal. Recommended by MICRO USER, PCN, HCW etc.

## THE KEY: £12.95

A disk utility program that provides the user with the tools to explore the disk environment and use it to its best advantage. The programs are:

- 1) FORM40 - Formats and verifies 40 track disks.
- 2) FORM80 - Formats and verifies 80 track disks.
- 3) BACKUP - Allows backup copies of your valuable disks to be made.
- 4) EDITOR - Enables the user to read the disk sector by sector and to alter programs on the disk, even most protected and unlistable ones. More fun than any adventure game.
- 5) RETRIEVE - Allows the user to recover data or programs that have been accidentally erased or damaged by a head crash.

Every disk owner should have one, you will wonder how you ever managed without it. Recommended by WHICH MICRO, EDUCATIONAL COMPUTING etc. 'THE KEY' has been imitated by many but bettered by none.



## JOYSTICK UTILITY: £6.00

Converts non joystick programs to work with joysticks. Works with any program using INKEY (-) in Basic or machine code, to detect movement, which applies to most programs. The routine is relocatable and sensitivity of the joystick can be varied. Compatible with most games, including Acornsoft. Very easy to use, just press the keys you want to transfer. The machine code can be saved as a block of just 100 bytes. Supplied on cassette but can be transferred to disk.



## SHADOW: £8.00

SHADOW is a tape cloning program that will enable you to make security copies of your own valuable cassette software. SHADOW works with 99% of all known programs including those with sections at 300 BAUD and those that load as files. SHADOW will handle programs with any number of sections and it will work with any of the current operating systems including 0.1, 1.0, & 1.2. SHADOW is the definitive tape backup system and as a bonus you also get 'INSPECTOR' on the same tape. This allows you to view all areas of memory, search and alter bytes, etc. Colour coding helps to simplify memory usage. All this for just £8.00. I don't know how we do it. 'It is a condition of sale that this program is not used for piracy'.

State 40 or 80 track when ordering discs.

NOTE: All prices are inclusive of VAT and postage - NO EXTRAS!

**Clares**  
MICRO SUPPLIES

**Dept. AU7, 98 Middlewich Road,  
Northwich, Cheshire, CW9 7DS.**

**Tel: 0606 48511** Open 9.5pm. Monday-Friday  
All prices inclusive of VAT + Carriage - No Extras.

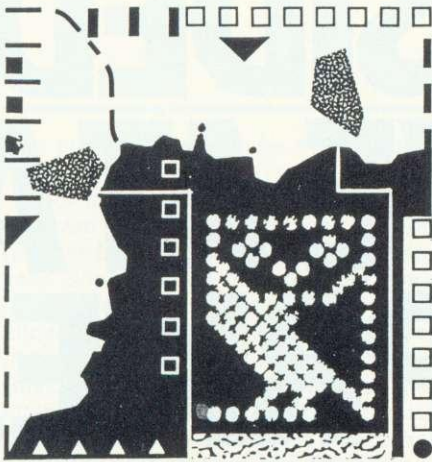

## Bruce Smith starts you off with advice on the Basic differences. Help from readers covers angled printing, Forth and the WP chips

### How to sort

### out your

### Basic confusion

AN EVENING'S computing at a friend's house recently brought out some interesting 'problems' that Beeb users all over the country have encountered over the last six months. I'd taken some utility programs with me on disc, but they just wouldn't run correctly, throwing up all sorts of error messages. Back at home, though, the same programs functioned correctly.

It was only after some severe head scratching that (somewhat more sober) I realised I had been trying to run programs written in Basic II on a Beeb fitted with Basic I. While Basic I programs work with Basic II, the reverse is not the case, and the differences are not always as obvious as in the much-publicised commands OPENUP and OSCLI and the EQU functions. For example, the following program will produce a syntax error when run on Basic I

```
10 INPUT FIRST$, SECOND%; THIRD
```

The offender here would be the semicolon, for only commas are allowed as delimiters in the Basic I INPUT statement. Replacing the semicolon with a comma solves the problem – a subtle difference, you'll agree.

A bit of investigation has resolved more of these naughty quirks. Here they are:

COUNT is a function used to hold the number of characters that have been printed across the screen. In Basic I it is unaffected by a mode change, but in Basic II it is zeroed by a mode change. The program:

```
10 PRINT "Acorn";
20 MODE 4
30 PRINT "User";
40 PRINT COUNT
```

would produce 9 in Basic I and 4 in Basic II, thus discrepancies in text formatting could occur.

The INSTR function is another command that can lead to a downfall. In Basic I the second string had to be shorter than the first for it to perform correctly, thus:

```
100 PRINT INSTR("Lydia", "d")
```

would return 3, but the following will not work:

```
100 PRINT INSTR("d", "Lydia")
```

Performing the latter in Basic II will result in INSTR returning the value of 0.

In Basic II the ELSE test can be used successfully inside functions or procedures as part of an ON ... GOTO ... ELSE or ON ... GOSUB ... ELSE structure, thus:

```
500 DEF PROC_Commander
(branch%)
510 ON branch% GOTO 520, 530, 540
ELSE GOTO 550
520 PRINT "A": ENDPROC
530 PRINT "B": ENDPROC
540 PRINT "C": ENDPROC
550 PRINT "Failed!": error% = 0:
ENDPROC
```

would not work in Basic I.

The EVAL statement is particularly useful for using the lexical analyser to evaluate expressions. This has been extended in Basic II to allow it to be used in conjunction with Basic's various pseudo-variables:

```
100 time$ = "TIME"
110 page$ = "PAGE"
120 himem$ = "HIMEM"
130 PRINT EVAL (time$)
140 PRINT EVAL (page$)
150 PRINT EVAL (himem$)
```

This is not possible in Basic I.

Basic II programs that manipulate strings can run out of memory, resulting in a 'No room' error when used with Basic I. This is because the allocation for string space in Basic II is more efficient than in Basic I. Amazingly, the following lines run in Basic I would eat up more than 3.75k of memory com-

pared to around 0.25k in Basic II:

```
10 REPEAT
20 X$ = X$ + "!"
30 UNTIL LEN (X$) = 255
```

The ABS command has been recoded to allow the unary minus to take the absolute value of an integer value without bit 31 set. Therefore:

```
PRINT -ABS(1)
```

will work in Basic II but will return the error message 'Type mismatch' in Basic I.

The mnemonic assembler can be thrown into an acute state of confusion in Basic I if a line such as:

```
140 LDA ASC":'
```

is used. Though this is assembled correctly by Basic II. The Basic II assembler will now also display its disgust with a 'Bad DIM' error if you try the following:

```
100 DIM P% - 2
```

These points should prove useful in converting Basic II programs to run on a Beeb with Basic I fitted. We'll pay a fiver for any relevant Basic II to I conversion tips we publish.

### One of the seven

### deadly sins

ANDY CROWHURST of Portishead, Bristol, writes: 'In Beeb Forum recently you have devoted pages to auto-running Basic programs. Come off it, the word RUN obviously makes the interpreter jump to an address. Therefore \*saving the program at this address will enable a Basic program to be \*RUN. The syntax for Basic I is therefore

```
*SAVE "PROG" <PAGE>
<TOP + 1> BD2C
```

page 77▶

Beeb Forum is a platform for ideas, tips and applications relating to the BBC micro and the Electron, intended for experienced programmers to share their thoughts. For every reader's tip published we pay £5 – or more for something special. Contributions should be typed or printed, with substantial listings on cassette. WRITE TO Beeb Forum, Acorn User, Redwood Publishing, London WC2E 9JH.

NOW AVAILABLE  
FROM W.H. SMITH

# A DOUBLE-SIDED 3" DISC DRIVE AT A SINGULAR PRICE.

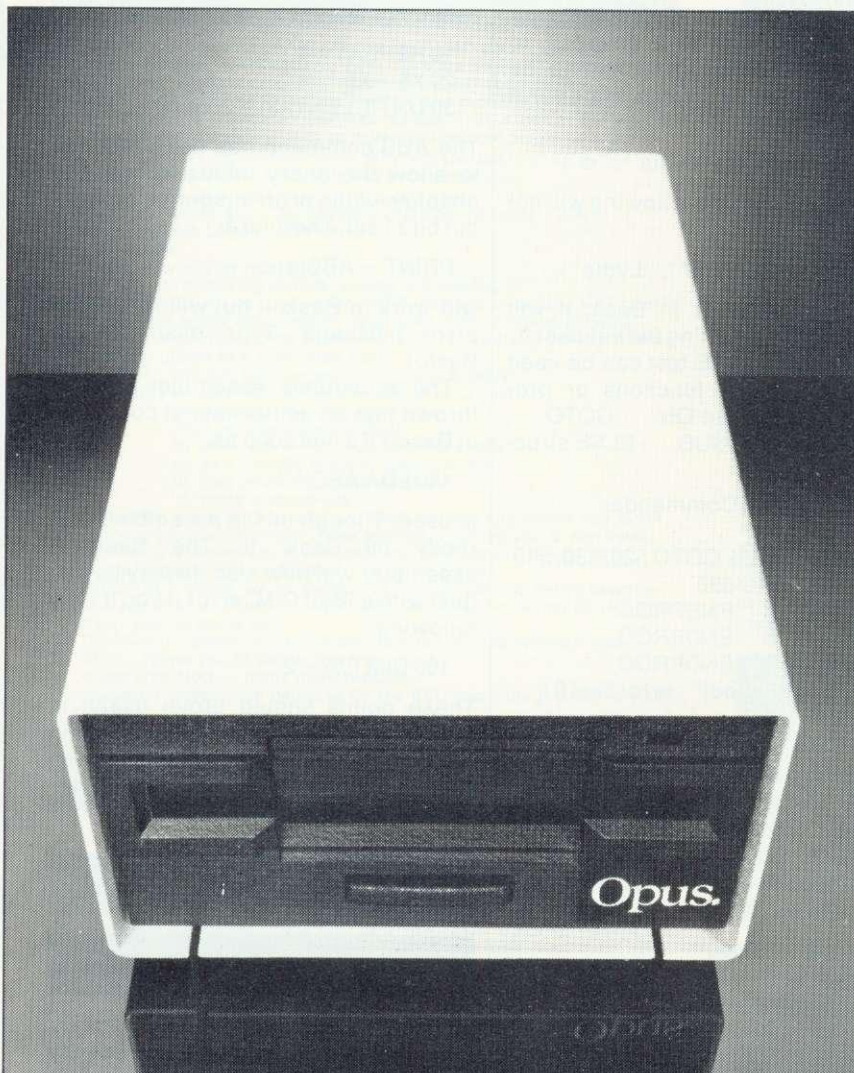

THE OPUS  
SUPER 3 MICRODRIVE.

**£229.95** (INC. VAT)

FOR USE WITH YOUR BBC MICRO.

For only £229.95 (and that includes VAT, and all the necessary leads) you can have an OPUS 500k double-sided disc drive. And remember 3" disc drives are fast becoming the standard for home and business use.

This is an even bigger bargain than it sounds. For you're getting a double sided drive at the price that other company's sell single sided drives for. It reads and writes to the disc cartridge from both sides, giving you twice the on-line capability of other 3" drives. And there's no need to flip the disc over!

#### STATE OF THE ART TECHNOLOGY FEATURING:

- Easy to connect to the BBC Micro
- Compatible with most other makes
- Comprehensive manual
- Free disc cartridge
- Format, verify and other utilities provided
- Direct Drive
- Double sided
- One touch cartridge load
- 3 ms access time
- Portable, compact and reliable
- One year's full guarantee
- Totally compatible with 5 1/4" drives

#### TECHNICAL PERFORMANCE.

	Single Density	Double Density
Capacity	250K Bytes	500K Bytes
Recording density	4,915 BP1	9,830 BP1
Track density	100 TP1	100 TP1
Total number of tracks	40 (each side)	40 (each side)
Recording method	FM	MFM
Rotational speed	300 RPM	300 RPM
Transfer rate	125K Bits Sec	250K Bits Sec
Access time track to track	3 ms	3 ms
Access time settling	20 ms	20 ms
Motor start time	0.5 sec	0.5 sec

The Opus Super 3 Microdrive is now available from W. H. Smith's and leading specialist shops.

Dual disc drives are also available for £460.

#### OPUS SUPPLIES LTD.

158 Camberwell Road, London SE5 0EE.

Opening hours: 9.00-6.00 Monday-Friday, 9.00-1.30p.m. Saturday. ☎ 01-701 8668  
01-703 6155

To: Opus Supplies Ltd., 158 Camberwell Road, London SE5 0EE. Please rush me the following: (ALL PRICES INCLUDE VAT & CARRIAGE.)

Quantity	Description	Price
	Single drive(s) at £229.95 ea.	
	Dual drive(s) at £459.95 ea.	
TOTAL		

I enclose a cheque for £ \_\_\_\_\_  
Or please debit my credit card account with the amount of £ \_\_\_\_\_ AC19  
My Access/Barclaycard (please tick) No. is \_\_\_\_\_

Name \_\_\_\_\_

Address \_\_\_\_\_

Telephone \_\_\_\_\_

**Opus.**  
Opus Supplies Ltd.

This program can then be \*RUN much more simply.'

This method does work but try the program on Basic II. It will load but not run. The Beeb has been provided with a very sophisticated set of operating system calls that if used correctly will allow programs written on any version of Basic to run on any other version of Basic. While jumping directly into the interpreter works it is not transferable and should be considered as one of the seven deadly sins on the Beeb (can anyone think of the other six?). We receive many programs that contain this type of illegal call into the interpreter and MOS, and this makes them unusable.

## Machine code

### auto-run

PHIL COLLET of Banbury adds to the Basic program auto-run saga by providing a piece of machine code that will auto-run a Basic program when it is loaded and also when Break or even CTRL-BREAK are hit. It therefore has advantages over the normal \*KEY10 method of programming the Break key.

The program (program 1, page vii) works by placing OLD <RETURN>, RUN <RETURN> into the REM statement of line 10, which initially contains 49 Xs. Lines 30 to 80 use the operating system to write to the Break intercept code and re-vector it to point to the REM-based machine code.

To use the program enter it as shown and then run it. Next delete all lines after line 60 and add or spool the Basic program onto the end of it. When complete save the lot with

```
*SAVE "NAME" <PAGE>
<TOP+1> <PAGE+6>
```

On a disc system the program can be chained using \*NAME and on a tape system \*RUN"NAME".

A safety valve can be built in to allow CTRL-BREAK to work by adding a line with \*FX247,0. The Escape key can be disabled with \*FX200,1.

Finally, Phil Collet has a plea to Beeb owners to provide a means of recovering strings and string arrays after a Break. £10 from the Editor's wallet for the best solution.

## Eccentric solution

### to string problem

CAMBRIDGE reader Philip Hazel writes:

There are a number of other approaches to J T Hindle's problem (Beeb Forum, April 1984), depending

on whether the use of store or speed of execution is the more important factor. He has an array of values Z which depend on two values X and Y. His note does not say explicitly that all these values are integral, but this fact is obvious from his solution. Using a two-dimensional array Z%(X%,Y%) requires nearly 9000 bytes of memory, since the values of X and Y range from 1 to 47. However, the values of Z range only from 1 to 71, which led to his somewhat eccentric solution of encoding the data in a character string.

The first comment is that, since the values of Z are so small, a two-dimensional array of bytes cuts the store usage by 75 per cent (since each integer value normally uses four bytes). Unfortunately, Basic does not provide the facility of using arrays of bytes, but this can be simulated using the indirection operators and the ability of DIM to allocate store and return its address.

Program 2 shows how to set up a 47 x 47 array, with indices ranging from 0 to 46, and clear it to zeros.

A reference to element (X%,Y%) of the array is then written as Z?(X%\*47+Y%). This method uses 2209 bytes of store but gives fast access to individual elements, and makes it easy to set new values. Indices 1 to 47 can, of course, be used instead of 0 to 46, but this requires more computation for each access.

A careful look at Mr Hindle's character string solution shows that, in his

case, the values of Z are unique, and each possible value of Z occurs precisely once. In fact, it seems that the (X,Y) pairs depend on the Z value, rather than vice versa.

Mr Hindle's solution does not in fact store values of Z, but merely a succession of (X,Y) pairs in the right order. Because he uses the INSTR function to search the string, separator characters are necessary. These can be done away with if the string representation is changed to an array of byte pairs. The data then occupies only 142 bytes. Program 3 shows how one could set up the array, using his example data for the first few bytes, and program 4 is a function which returns the Z value corresponding to a given (X,Y), or zero if there is no such value.

Of course, the price paid for such close packing of the data is the time taken by FNZ to search for the (X,Y) values. If it is the case that the X or Y values (or both) increase as Z increases (which is true in the example above) then FNZ can be speeded up by stopping when a value is found that is greater than the one being sought. Alternatively, a technique such as 'binary chop' can be used.

Mr Hindle's problem is an example of a more general problem of how to store sparse arrays efficiently. If the 71 values of Z were not the first 71 integers, but arbitrary (possibly non-unique) values in the range 1-255, then, of the solutions discussed so far, only the two-dimensional array would work.

## Angling text in multicolour

GRAHAM WALKDEN of Banchory, Kincardine, has sent a listing (program 5) allowing the users of the BBC A and B and Electron to produce multicoloured, enlarged text at any position

and/or angle in any graphics mode.

The routine works by printing the message to be placed on the screen, and using the POINT command to sense whether a pixel is to be plotted or

page 79▶

**SUPERPRINT Demo**

NORMAL SIZED

Any Angle

FOR BBC MODE 4  
OR BBC MICRO MODEL B

**BY GRAHAM WALKDEN**

# Edfax

## TELETEXT emulator

Now you can create your own electronic magazine, noticeboard or database using Edfax with your BBC 'B' and disk drive. The powerful EDIT program allows you to implement all the features of a commercial teletext system including coloured text and graphics, coloured backgrounds, double height, flash, conceal/reveal, 'separated' graphics, 'hold' graphics or any combination of these. 'Define pixels' facility enables complex displays to be created easily. 'Cycle page' facility enables you to create sequences of pages for automated displays. Any page is easily updated.

Edfax stores up to 80 pages on a 40-track disk and a massive 182 pages on an 80-track disk. Separate DISPLAY program enables any page (or sequence of pages) to be recalled simply by entering a three digit number.

Edfax is entirely content-free and is ideal for use in education (art and design, English, computer studies, language development, recording of events, display of students' work, etc), and for

retail display, exhibitions, noticeboard applications and wherever the presentation of *information* is important. Edfax is supplied with an 80-page sample database full of useful ideas and examples. Also included is a coloured keystrip, screen planning sheet and an 88-page users' guide, written and edited by educationalists, which explains how to create and structure Edfax pages and provides many worked examples.

**Available ex-stock at £30.00 plus £2.00 p&p and £2.68 VAT (total £34.68).**

United Kingdom schools pay only £20.00 plus £2.00 p&p and £1.88 VAT (total £23.88).

Send cheque or LEA order to:  
**Tecmedia Limited, Dept MA/1, 5 Granby Street,  
 Loughborough, LE11 3DU,**  
 stating 40- or 80-track version, or write for colour brochure. Trade enquiries welcome.

Requires BBC 'B' with OS 1.0 (or later) and any Acorn compatible DFS. 40- and 80-track versions available. 3" version available soon. DISPLAY software and Edfax datafiles may be used with Econet (Level II only).



Edfax was developed by the Microelectronics Education Programme.

a **Tecmedia** software product

# Increase your fire power!

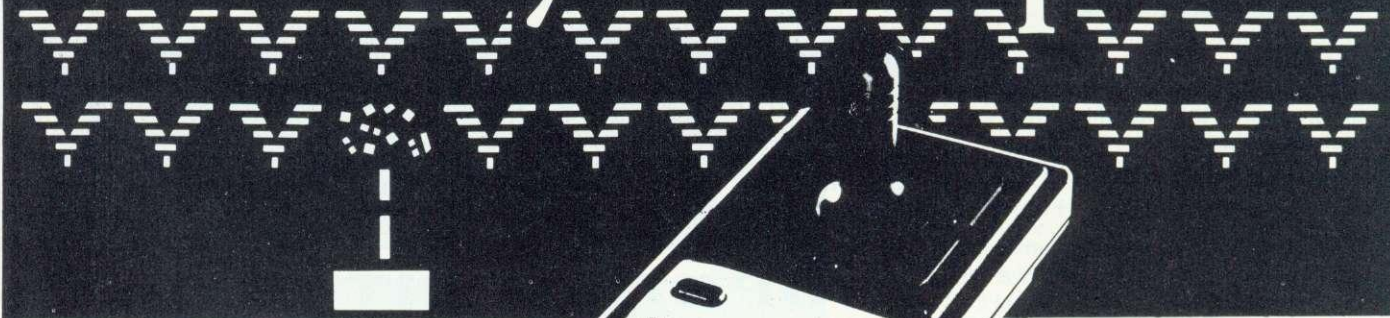

## More than just a joystick - a system

- ▲ Nylon encased - Steel shafted joystick with ball and socket joint.
- ▲ Fast sprung return to centre.
- ▲ Graphite wiper linear potentiometers.
- ▲ 12 Months Guarantee.
- ▲ 7 day Money back Guarantee (on Hardware).

**DELTA 14b HANDSET £14.95**  
**DELTA 14b/1 A/D/USER PORT INTERFACE £14.85**  
**DELTA DRIVER CASSETTE £5.95 or DISC £9.95**  
 Prices include VAT and P&P. SAE for more detailed information.

**VOLTMACE LTD**  
**PARK DRIVE**  
**BALDOCK**  
**HERTS**  
**SG7 6EZ**  
**Tel: (0462) 894410**

Numerous stockists nationwide or direct from us.

Callers welcome at the factory - Monday to Friday.



## Complete control at your fingertips

A superb joystick and a keypad for the price of either one. Plus the software to integrate it into the computer's system.

One handset will work on its own in the A/D port as a joystick and two fire buttons. Joystick is immediately compatible with ACORNSOFT and similar software. The interface joins together the analogue and the user ports to use the full keypads giving a total of 24 user definable keys. The interface can also be used as a splitter for the A/D port to take two items at the same time, e.g. joystick and lightpen.

DELTA DRIVER on cassette or disc: Two programs on each cassette or disc. One converts machine code programs from the keyboard to the joystick or keypad, with adjustable sensitivity on the joystick and will run on any O.S. The second program (needs O.S. 1.0 or later and an interface) duplicates any keyboard keys on the keypads, in the operating system, so that it can become a numeric keypad or will take on the function keys.

**voltmacedelta 14b**



not. Before the program will operate several variables have to be assigned.

M% – the number. The number of pixels in your particular mode has to be multiplied to produce either 1280 for the horizontal axis or 1024 for the vertical, eg, it is 2 in a 640 × 256 mode, 4 in a 320 × 256 mode and 8 in a 160 × 256 mode. Best results are obtained by using mode 1.

XMAG% – the horizontal magnification factor. One is normal.

YMAG% – the vertical magnification factor, 1 again being normal.

COL% – the colour of the characters to be printed (normal colour rules apply).

ANG% – the angle at which the text will be printed. Positive values cause the text to slant upwards, while negative values do the opposite.

To call up the routine you have to use a system of variable-assigned procedures, i.e. PROCPRINT ("Text to be printed", (X co-ordinate), (Y co-ordinate)). So:

```
10MODE1: M% = 4: XMAG% = 2:
    YMAG% = 2: COL% = 2:
    ANG% = 2: PROCPRINT
    ("HELLO", 640, 512): END
```

will cause the word HELLO to be printed in yellow, upward-slanting, double-height, double-width lettering in the centre of the screen.

*Superprint* can be used for all sorts of purposes, and is considerably more effective than the mode 7 double-height lettering.

## Arrays as

## parameters

IN HER ARTICLE 'Brush up on your writing' (April issue, page 111), writes Allen Hardy of Birmingham, Susan Jones describes some useful facilities peculiar to BBC Basic but observes that it is not possible, without using indirection operators, to write a general procedure using arrays because arrays cannot be parameters. The problem is also discussed by John Ryding (same issue, page 89).

Here's how to do it: the name of the array is passed to the procedure (or function) as the actual parameter, and EVAL is used in the procedure definition to evaluate the formal parameter. Program 6 calls Ms Jones' PROCWordin, rewritten as a function using an array parameter.

The function is similar to PROCWordin in that it repeats a question until you reply with one of the words in the DATA line. It returns the position of the word in the array (the index) to

the main program, which prints it.

Unlike John Ryding's technique, this one can be used only to read arrays and not to write to them.

## Showing the flag

## for Forth

RICHARD CLARKE of Croydon has some Forthright views. He writes:

It is rare to see items in *Acorn User* relating to BBC languages other than Basic or assembly language. As an Acornsoft Forth user, I hope to set a precedent for others to send in their ideas and thus make Forth more widely known.

Initially, Acornsoft Forth sets LIMIT, the top of memory pointer, to &5800 and allows you two mass-storage buffers (screens). If you are going to use only mode 7, memory from &5800 to &7C00 will be free. To take advantage of this, increase the top of memory pointer to &7C00 by:

```
31744' LIMIT!
```

and re-allocate storage for your buffers by:

```
n#BUF!SETBUF FLUSH
```

where n is the number of buffers you want (see Forth manual, pages 81–82).

Now that you are using what would be screen memory in any other mode to store your source-code, you must take care not to change mode. This can be done inadvertently by EMITting 22, followed by another number, or TYPEing a string containing 22, which is quite possible if you are using TYPE on the wrong area of memory by mistake. I have found it very useful to prevent 22 being sent to the VDU drivers by the following:

```
DECIMAL : &EMIT DUP 22 = 26
?ERROR (EMIT);
ASSIGN EMIT TO-DO &EMIT
```

Now, 22 EMIT gives EMIT ? MSG #26. You can disable this by:

```
ASSIGN EMIT TO-DO (EMIT)
```

## Multiple printing

## with Wordwise

JONATHAN EVANS of Plymouth points out that one of the limitations of Wordwise is that it does not have a facility for multiple printing. This can be very annoying, he says, if you want to run off a number of copies of a short document on fanfold paper. Program 7 provides a short Basic program to simulate this function.

First, design your document on Wordwise in the normal way and proof it carefully. Then save to disc or tape using option 8. This 'spools' the formatted text as an ASCII file (you will lose any special control codes to the printer for underlining etc when you do this). Then return to Basic and run the program. This will read your file into a single byte array and print it out for you as many times as required.

All formatting is preserved by the simple byte-by-byte PRINT CHR\$ at line 280. For example, blank lines are coded as carriage returns (ASCII 13) which are automatically produced by PRINT CHR\$(13).

## Automatic formatter

## in View

THE routine by Susan Jones 'Saving text for View' is a splendid idea, says Bernard Wilson of Ilkley. 'It certainly allows me to make better use of my own micro at home, using a View machine to format and edit the results.'

'However,' he adds, 'it is a bit tedious to have to press RETURN after each line, and forgetting to do so can ruin the whole text. I have improved the routine (see listing 8) to insert a RETURN and to format each line automatically, and to allow text generation in either Mode 3 or Mode 7 (invaluable if you are using a TV).'

## More on

## sequential tapes

G A SMITH has some comments to make on P H Cowley's suggestion for running of programs in sequence on tape (April issue, page 58). He says:

Listing 5 will not work as shown. Line 1 appears to have been added after the program was tested, thus changing TOP-2 to &E31 rather than &E21. Either delete line 1, or change 0E21 to read 0E31. A neater, and more general, solution would be:

```
2 LOMEM = HIMEM - &1000
4 top$ = STR$(TOP - 2)
6 REPEAT
8 DIM X% - 1: Y% = X% DIV 256
10 $X% = "L." + top$
12 CALL - 9
```

'L.' in this case is, of course, an abbreviation for LOAD. 'CALL - 9' is a slightly cheaper way of calling the OSCLI at &FFF7.

Incidentally, 'CALL! - 4' is a useful way of generating reset, rather than the release-dependent call shown in January's Beeb Forum, page 69.

**UNREPEATABLE BARGAIN OFFER  
FROM MIDWICH  
ONLY WHILE STOCKS LAST!  
1,000 BBC MICRO COMPATIBLE  
DISC DRIVE UNITS  
TO CLEAR**

**£99.95**  
**INC. VAT**

(SIMILAR MODELS AT LEAST £200 ELSEWHERE)

Includes connecting cable, DFS Manual and Formatting Disc.

We need to clear our stocks of brand new Shugart SA 410 Disc Drive Units, to make way for new merchandise in our warehouse.

Each 5¼" standard height drive has a 200K, single side, 80 track capacity and includes manufacturer's full warranty.

Cash with order only to include carriage at £3.50 per drive.

Telephone your credit card order now.

**HURRY, OFFER ONLY APPLICABLE WHILE STOCKS LAST.**

**MIDWICH**  
**COMPUTER COMPANY LIMITED**

RICKINGHALL HOUSE, HINDERCLAY ROAD, RICKINGHALL, SUFFOLK IP22 1HH. TELEPHONE: DISS (0379) 898001.

# TOP OF THE LIST

Top of the List is a new regular feature in *Acorn User* in which we publish the most interesting, original or useful program received. Our first winner – we pay £25 for the one we publish – is Andrew Britton, who sent us a function key strip printer tested on the Epson FX80, MX80 and RX80 printers and the Star DP510. As it stands the program will print you a sample keystrip suitable for use with View. By editing your own items into the data statements you can

define your own keystrips. To leave a key blank move on to the next item by adding a comma, as demonstrated in line 480 of the program.

Submitted listings should be no longer than 100 lines and authors should enclose a cassette or disc containing the program and, if it is to be returned, an sae.

Entries to: Top of the List, *Acorn User*, 68 Long Acre, London WC2E 9JH.

1

```

10 REM *** FUNCTION KEY STRIP PRINTER ***
20 REM *** BY ANDREW BRITTON ***
30 REM *** (C) Acorn User July 1984 ***
40:
50 MODE 0
60 PRINT "Function key strip printer (By Andrew Britton (C) 1984)."
70 PRINT "'Enter text in DATA lines at end.'"
80 PRINT "'Set up printer and press <RETURN>";:*FX 21,0
90 REPEAT UNTIL GET=13
100:
110 n=12
120 VDU 2
130 VDU 1,27,1,64 :REM Reset printer
140 VDU 1,15 :REM Condensed characters
150 VDU 1,27,1,ASC"U",1,1 :REM Unidirectional
160 VDU 1,27,1,ASC"3",1,16 :REM Line spacing 16:STAR/MX 24:FX/RX
170:
180 PRINT:PRINT
190:
200 FOR A%=1 TO 10:PRINT "+";STRING$(n,"-");:NEXT:PRINT "+"
210:
220 FOR L%=1 TO 3
230 IF L%<3 PROCplin(2) ELSE PROCplin(3)
240 FOR A%=1 TO 10:PRINT "+";STRING$(n,"-");:NEXT:PRINT "+"
250 NEXT
260:
270 PRINT:PRINT:PRINT
280 VDU 3
290 END
300:
310 DEF PROCplin(n%)
320 FOR z%=1 TO n%
330 FOR N%=1 TO 10:READ A$:PRINT "!";A$;SPC(n-LEN(A$));:NEXT:PRINT "!"
340 NEXT
350 ENDPROC
360:
370 REM data limited to a maximum of 12 characters/field
380 REM ***** Sample Keystrip For VIEW word processor *****
390:
400 DATA DELETE,NEXT,FORMAT,JUSTIFY,INSERT,DEFAULT,SPLIT,CONCAT,MARK,
410 DATA BLOCK,MATCH,MODE,MODE,MODE,RULER,LINE,LINES,AS RULER,
420:
430 DATA MOVE,SWAP,RELEASE,DELETE TO,HLT,HLT,GOTO,SET,EDIT,DELETE
440 DATA BLOCK,CASE,MARGINS,CHARACTER,1,2,MARKER,MARKER,COMMAND,COMMAND
450:
460 DATA FORMAT, TOP OF, BOTTOM, DELETE, BEGINNING, END OF, INSERT, DELETE, INSERT, DEL
ETE
470 DATA BLOCK, TEXT, OF TEXT, END OF LINE, OF LINE, LINE, LINE, LINE, CHARACTER, CHARA
CTER
480 DATA , , , , , , , ,

```

DELETE BLOCK	NEXT MATCH	FORMAT MODE	JUSTIFY MODE	INSERT MODE	DEFAULT RULER	SPLIT LINE	CONCAT. LINES	MARK AS RULER	
MOVE BLOCK	SWAP CASE	RELEASE MARGINS	DELETE TO CHARACTER	HIGHLIGHT 1	HIGHLIGHT 2	GOTO MARKER	SET MARKER	EDIT COMMAND	DELETE COMMAND
FORMAT BLOCK	TOP OF TEXT	BOTTOM OF TEXT	DELETE END OF LINE	BEGINNING OF LINE	END OF LINE	INSERT LINE	DELETE LINE	INSERT CHARACTER	DELETE CHARACTER

See pages 51-54

## Listings 1-5. Testing the keyboard for the space bar

```
10 REM listing 1
20 CLS
30 PRINTTAB(6,10)"Please press the space bar"
40 REPEAT
50 A=INKEY(-99)
60 UNTIL A=-1
70 PRINTTAB(15,15)"Thank you"
```

```
10 REM listing 2
20 CLS
30 PRINTTAB(6,10)"Please press the space bar"
40 REPEAT
60 UNTIL INKEY(-99)
70 PRINTTAB(15,15)"Thank you"
```

```
10 REM listing 3
20 CLS
30 PRINTTAB(6,10)"Please press the space bar"
40 A=INKEY(300)
50 IF A=32 THEN PRINTTAB(15,15)"Thank you"
60 IF A>32 THEN PRINTTAB(15,15)"Wrong key!"
70 IF A=-1 THEN PRINTTAB(15,15)"Too slow!"
```

```
10 REM listing 4
20 CLS
30 PRINTTAB(6,10)"Please press the space bar"
40 REPEAT
50 UNTIL GET=32
60 PRINTTAB(15,15)"Thank you"
```

```
10 REM listing 5
20 CLS
30 PRINTTAB(6,10)"Please press the space bar"
40 REPEAT
50 UNTIL GET#=" "
60 PRINTTAB(15,15)"Thank you"
```

## Listings 6 and 7. Space bar test procedures for modes 1/4 and 2/5 respectively

```
10 REM Listing 6
20 MODE 4
30 PROCspace
40 PRINT"IT WORKS!"
50 END
60 :
10000 DEFPROCspace
10010 REM Mode 1/4 procedure to wait
10020 REM until space bar is pressed
10030 VDU 24,175;10;1100;60;5,18,0,131
10040 VDU 12,18,0,0
10050 MOVE200,47
10060 PRINT"Press space bar to continue"
10070 *FX15,0
10080 REPEAT:UNTIL GET=32
10090 VDU 18,0,128,18,0,3,16,4,26
10100 ENDPROC
```

```
10 REM Listing 7
20 MODE 5
30 PROCspace
40 PRINT"IT WORKS!"
50 END
60 :
10000 DEFPROCspace
10010 REM Mode 2/5 procedure to wait
10020 REM until space bar is pressed
10030 VDU 24,120;10;1160;60;5,18,0,131
10040 VDU 12,18,0,0
10050 MOVE180,47
10060 PRINT"Press space bar"
10070 *FX15,0
10080 REPEAT:UNTIL GET=32
10090 VDU 18,0,128,18,0,3,16,4,26
10100 ENDPROC
```

Program 1. Joe Telford's RS423 simulator

```

10 REM SERIAL TRANSMISSION SIMULATOR
20 REM J.TELFORD APR. 1984
30 PROCinit
40 REPEAT
50     MODE7
60     PROCmenu
70     MODE4:PROCsetscreen
80     REPEAT
90         char=FNtype
100        IF char<>27 PROCsend(char)
110        UNTIL char=27
120    UNTIL FALSE
130 END
140 DEFPROCinit
150 VDU23,128,128,128,128,128,128,128,128,255
160 VDU23,129,255,128,128,128,128,128,128,128
170 VDU23,130,187,170,170,170,170,170,170,238
180 VDU23,131,143,136,136,136,136,136,136,248
190 VDU23,132,60,126,255,255,255,255,126,60
200 VDU23,133,60,66,129,129,129,129,66,60,
210 VDU23,134,0,62,8,10,106,138,138,107
220 DIM binary(12)
230 *FX220,@
240 ENDPROC
250 DEF PROCmenu
260 CLS
270 REPEAT INPUTTAB(0,5)"How many data bits/word? (7/8) "D%
280     IF D%<>8 AND D%<>7 VDU7
290     UNTIL D%>6 AND D%<9
300 REPEAT
310     REPEAT:INPUTTAB(0,7)"0(dd) E(ven) or N(o) Parity? "parity%
320         parity%=LEFT$(parity%,1)
330         P%=INSTR("0ENoen",parity%)
340         IF P%<1 VDU7
350         UNTIL P%>0
360         IF P% MOD 3 =0 AND D%=7 PRINT'CHR$131"7 bits and No Parity is
           not allowed.":VDU7
370         UNTIL P% MOD 3 (<>0 OR D%<>7)
380 P%=P% MOD 3
390 REPEAT:INPUTTAB(0,11)"How many stop bits? (1/2) "S%
400     IF S%<>1 AND S%<>2 VDU7
410     UNTIL S%>0 AND S%<3
420 IF D%=8 AND S%=2 PRINT'CHR$131"1 stop bit only with 8 Data
           bits":S%=1:VDU7
430 PRINTTAB(0,15)CHR$131:CHR$136;"Press SPACE to Continue"
440 REPEAT UNTIL GET=32
450 ENDPROC
460 DEF PROCsetscreen
470 CLS
480 VDU19,0,4,0;0;0;19,1,7,0;0;0;
490 PROCrect(0,0,1279,1023)
500 PROCrect(320,866,224,96)

```

Continued ►

See 'Logging On', page 32

IV

◀ Continued

```

510 PROCrect(736,866,224,96)
520 PRINTTAB(11,3)"CTS ";CHR#133
530 PRINTTAB(24,3)"RTS ";CHR#133
540 PROCrect(128,610,160,192)
550 PROCrect(128,610,160,96)
560 PROCrect(384,610,160,96)
570 PROCrect(384,610,160,192)
580 PRINTTAB(5,8)"CHR"
590 PRINTTAB(13,8)"ASC"
600 PRINTTAB(26,8)"BINARY."
610 PROCrect(736,610,416,192)
620 PROCrect(736,610,416,96)
630 PROCrect(128,354,416,192)
640 PROCrect(128,354,416,96)
650 PROCrect(736,354,416,192)
660 PROCrect(736,354,416,96)
670 PRINTTAB(8,16)"R5432"
680 PRINTTAB(27,16)"MODEM"
690 PRINTTAB(5,26)"SERIAL TRANSMISSION SIMULATOR"
700 PROCchr(0)
710 ENDPROC
720 DEF FNtype
730 PROCcts(1)
740 *FX21,0
750 =GET
760 DEFPROCcts(x)
770 PRINTTAB(15,3);CHR$(132+(1-x))
780 ENDPROC
790 DEF PROCsend(ch)
800 PROCcts(0)
810 PRINTTAB(6,11);
820 IF ch>31 AND ch<127 PRINTCHR#ch ELSE PRINTCHR#134
830 PRINTTAB(13,11)"  ":PRINTTAB(16-LEN(STR$(ch)),11);ch
840 PROCbinary
850 PROCRS432
860 PROCMODEM
870 PROCsound
880 ENDPROC
890 DEFPROCbinary
900 length= D%+5%+SGN(P%)+1
910 binary(0)=0
920 IF D%=7 ch= ch AND 127
930 total=0:FOR I%=1 TO D%
940 binary(I%)=ch MOD 2:ch=ch DIV 2
950 total=total+binary(D%-I%)
960 NEXT
970 binary(length-1)=1
980 IFS%=2 binary(length-2)=1
990 IF P%=0 PROCprintbin:ENDPROC
1000 binary(D%+1)=1
1010 IF P%=1 AND (total MOD 2)=1 binary(D%+1)=0
1020 IF P%=2 AND (total MOD 2)=0 binary(D%+1)=0
1030 PROCprintbin:ENDPROC
1040 DEF PROCprintbin

```

```

1050 PRINTTAB(24,11);STRING$(length," ")
1060 PRINTTAB(24,11);
1070 FOR IX= 0 TO length-1
1080   PRINT;binary(IX);
1090   NEXT:ENDPROC
1100 DEFPROCrs432
1110 PRINTTAB(5,19);STRING$(length," ")
1120 PRINTTAB(5,19);
1130 FOR IX= 0 TO length-1
1140   VDU128+binary(IX)
1150   NEXT:ENDPROC
1160 DEFPROCMODEM
1170 PRINTTAB(24,19);STRING$(length," ")
1180 PRINTTAB(24,19);
1190 FOR IX= 0 TO length-1
1200   VDU130+binary(IX)
1210   NEXT:ENDPROC
1220 DEFPROCsound
1230 FOR IX= 0 TO length-1
1240   SOUND1,-15,binary(IX)*48+156,0
1250   NEXT:ENDPROC
1260 DEFPROCcansn(x):IFx=0 THEN VDU23;
      8202;0;0;0;:ELSE VDU23;29194;0;0;0;
1270 ENDPROC
1280 DEF PROCrect(x,y,1,w)
1290 MOVEx,y:DRAWx+1,y
1300 DRAWx+1,y+w
1310 DRAWx,y+w
1320 DRAWx,y
1330 ENDPROC

```

**Program 2. Direct BBC to BBC comms.**

```

10 REPEAT:IF(?&FE08 AND 1)=1 ch=?&FE09:
   VDUch:IF ch=13 PRINT
20 A#=INKEY$(0):IFA#(">") ?&FE09=A$CA#:
   PRINTA#::IFA#=CHR#13 PRINT
30 UNTILO

```

**Program 3. Pocket terminal program for most modems and phone comms.**

```

5 *FX8,3
6 *FX7,3
10 REPEAT:IF(?&FE08 AND 1)=1 VDU(?&FE09 AND 127)
20 A#=INKEY$(0):IFA#(">") ?&FE09=A$CA#
30 UNTILO

```

# AN INSPECTOR CALLED

INSPECT is a useful utility provided by Martin Clayden, which enables you to examine a Basic program held on disc without affecting one already in memory.

To use the program type in the source program as shown, run it then save the object code using:

\*SAVE "VIEW" 8D0 9F0 8D0

Ensure that the program you wish to view is on the same disc and enter:

\*INSPECT <fsp>

where fsp is the name of the file to be viewed. If the program cannot be found the message 'File not found' will be issued.

If the program is too large to fit in the

available memory the message 'INSPECT space' will be displayed. 'Not Basic' will be output if the program is not a Basic program.

As the Beeb is placed into paged mode by the program the Shift key should be pressed to continue the listing.

Pressing Escape at any time will abort the listing.

VI

```

● 100 REM *** INSPECT V1.2 ***
110 REM *** By M.Clayden ***
● 120 REM *** Acorn User ***
130
● 140 osfind=&FFCE:osargs=&FFDA:
osfile=&FFDD
● 150 oswrch=&FFEE:osnewl=&FFE7:
osbyte=&FFF4
● 160 page=&18:maxsize=&87:
handle=&B4:top=&13
● 170 loadin=&8E:hmem=7
● 180 BRKV=&202:BASIC=&8A99:
BREAK=&B433
● 190 FOR PASS=0 TO 3 STEP 3
200 P%=&0BD0
● 210 LOPT PASS
220 LDX top
● 230 INX
240 STX loadin \RECORD TOP
● 250 LDX hmem \STORE
260 DEX \VALUE OF
● 270 TXA \LARGEST
280 SEC \LOADABLE
● 290 SBC loadin \PROGRAM
300 STA maxsize \FOR THIS MODE
● 310 LDX #5
320 LDA #700,X \GET COMMAND
● 330 CMP #&20 \SPACE ?
340 BEQ ok1
350 LDX #(SY-MSG) \SYNTAX
● 360 JMP out2
370 .ok1
● 380 INX
390 LDA #&40 \OPEN FOR
● 400 LDY #7 \READ
410 JSR osfind \ONLY
● 420 STA handle
430 BNE ok2
● 440 LDX #(NF-MSG) \NOT FOUND
450 JMP out2
460 .ok2
● 470 TAY
480 LDX #&70
● 490 LDA #2
500 JSR osargs
● 510 LDA #71 \SIZE - HI
520 CMP maxsize
● 530 BCC ok3
540 LDX #(VS-MSG) \TOD LARGE
● 550 JMP out1
560 .ok3
● 570 JSR close
580 LDA #0 \CLEAR
● 590 LDX #&12 \PARAMETER
600 .cl \SPACE
● 610 STA #&6F,X
620 DEX
● 630 BNE cl
640 LDA #5 \POINT TO
650 STA #70
660 LDA #7 \FILE NAME
670 STA #71
680 LDA loadin
690 STA #73
700 LDX #&70 \POINT TO
710 LDY #0 \PARAMETER
720 LDA #&FF BLOCK
730 JSR osfile \LOAD FILE
740 LDY #0
750 STY loadin-1
760 LDA (&8D),Y
770 CMP #&0D
780 BEQ ok4 \CHECK THAT
790 LDX #(NB-MSG) \IT IS BASIC
800 JMP out1
810 .ok4
820 LDA #(newv
MOD 256)
830 STA BRKV \REDIRECT
840 LDA #(newv
DIV 256)
850 STA BRKV+1 \BREAK VECTOR
860 LDA loadin
870 STA page
880 LDA #12
890 JSR oswrch \CLEAR SCREEN
900 LDX #(V-MSG)
910 JSR output
920 LDA #14
930 JSR oswrch \PAGING ON
940 LDA #138
950 LDX #0
960 .inbuf \PUT LIST
970 STX #80 \AND
980 LDY RS,X \?24=25
990 BEQ out \IN
1000 LDX #0 \KEYBOARD
1010 JSR &FFF4 \BUFFER
1020 LDX #80
1030 INX
1040 JMP inbuf
1050 .out
1060 RTS
1070 .output \DISPLAY
1080 .char LDA \MESSAGE
MSG,X
1090 JSR oswrch \ROUTINE
1100 INX
1110 CMP #&0D
1120 BNE char
1130 JSR osnewl
1140 RTS
1150 .close
1160 LDY handle
1170 LDA #0 \CLOSE THE
1180 JSR os \FILE
1190 RTS \AND END
1200 .out1
1210 JSR close
1220 .out2
1230 JSR output
1240 RTS
1250 .newv
1260 LDA #126 \ACKNOWLEDGE
1270 JSR osbyte \ESCAPE
1280 LDA #25
1290 STA page \RESTORE PAGE
1300 JSR osnewl
1310 LDA #(BREAK
MOD 256)
1320 STA BRKV \RESTORE
1330 LDA #(BREAK
DIV 256)
1340 STA BRKV+1 \BREAK VECTOR
1350 JMP BASIC
1360 RTS
1370 MSG
1380 J
1390 REM ADD TEXT TO END
OF CODE
1400
1410 len=0:NB=FTEXT
("Not BASIC")
1420 V=FTEXT
("Inspecting")
1430 VS=FTEXT
("INSPECT space")
1440 SY=FTEXT
("Syntax: INSPECT <fsp>")
1450 NF=FTEXT
("File not found")
1460 RS=FTEXT
("L." +CHR$(13) + "?24=25"
+CHR$(13) +CHR$(0))
1470 NEXT PASS
1480 END
1490 DEFFTEXT(A$)
1500 L=len:len=len+LEN(A$)+1
1510 $(MSG+L)=A$
1520 =MSG+L

```



## Program 1. Machine code program to auto-run a Basic program, by Phil Collet

```

> 10 REMXXXXXXXXXXXXXXXXXXXXXXXXXXXXXXXXXXXX
XXXXXXXXXXXXXXXXXXXXXXXXXXXX
20 VDU15
30 #FX247,76
40 #FX248,6
50 A%=249 : Y%=0 : X%=PAGE DIV 256
60 CALL &FFF4
70 FOR I%=0 TO 3 STEP3
80 P%=PAGE+6
90 IOFT I%
100 LDA #138
110 LDX #0
120 LDY #79
130 JSR &FFF4
140 LDY #76
150 JSR &FFF4
160 LDY #68
170 JSR &FFF4
180 LDY #14
190 DEY
200 JSR &FFF4
210 LDY #82
220 JSR &FFF4
230 LDY #85
240 JSR &FFF4
250 LDY #78
260 JSR &FFF4
270 LDY #14
280 DEY
290 JSR &FFF4
300 RTS : J
310 NEXT
    
```

## Program 2.

```

10 DIM Z 47*47
20 FOR X% = 0 TO 46
30 T% = X%*47
40 FOR Y% = 0 TO 46
50 Z?(T%+Y%) = 0
60 NEXT Y%
70 NEXT X%
    
```

## Program 3.

```

10 DIM Z 142
20 FOR I% = 0 TO 141
30 READ J%
40 Z?I% = J%
50 NEXT
60 DATA 1,1,2,7,12,8,...
    
```

## Program 4.

```

10 DEF FNZ(X%,Y%)
20 LOCAL I%
30 I% = 0
40 REPEAT
50 IF (Z?(I%)=X%) AND (Z?(I%+1)=Y%) THEN = (I% DIV 2) + 1
60 I% = I% + 2
70 UNTIL I% > 140
80 =0
    
```

## Program 5. New angles on screen lettering by Graham Walkden

```

> 5 REM SUPERPRINT - GRAHAM WALKDEN
10 MODE1
20 COL%=3:M%=4:XMAG%=2:YMAG%=2:ANG%=0
30 PROCPRINT("SUPERPRINT Demo",70,960
)
40 COL%=1:XMAG%=1:YMAG%=2:ANG%=4
50 PROCPRINT("Any Angle",820,600)
60 XMAG%=1:YMAG%=1:ANG%=0
70 PROCPRINT("NORMAL SIZED",100,750)
80 COL%=3:ANG%=-2
90 PROCPRINT("FOR BBC MICRO MODEL B",
100,550)
100 COL%=3:ANG%=2:PROCPRINT("OR BBC A-
MODE 4",120,300)
110 COL%=2:ANG%=0:XMAG%=1:YMAG%=2
120 PROCPRINT("BY GRAHAM WALKDEN",110,
100)
130 PROCPRINT(" ",0,0)
200 END
250 :
30010 DEF PROCPRINT (D$,X%,Y%)
30020 X1%=X%:Y2%=Y%:GCOL0,COL%
30030 PRINTTAB(0,30);D$;STRING$(39-LEND$
," ")
30040 FOR J=32 TO 64 STEP(M%/YMAG%):Y1%=
Y2%
30050 FOR I%=0 TO (LEND$(M%*8))STEPM%
30060 IFPOINT(I%,J)<>0PLOT69,X1%,Y1%:PLO
T1,M%*XMAG%,0:X1%=X1%+M%*XMAG%+2 ELSEX1%
=X1%+M%*XMAG%+2
30070 Y1%=Y1%+ANG%
30080 NEXT
30090 X1%=X%:Y2%=Y2%+4
30100 NEXT
30110 ENDPROC
    
```

VII

## Program 6. Using an array parameter, by Allen Hardy

```

> 10 REM
20 N=5
30 DIM TABLE$(N)
40 FOR I=1 TO N
50 READ TABLE$(I)
60 NEXT I
70 PRINT FNWORDIN("TABLE","WHICH DIRECTION",N)
80END
90 =====
100 DEFFNWORDIN(ARRAY$,MESS$,N) LOCAL W,WORD$
120 REPEAT PRINTMESS$;:INPUT WORD$:W=0
130 REPEAT W=W+1
140 UNTIL WORD$=EVAL(ARRAY$+"$("+STR$W+")") OR W=N
150 UNTIL W<N
160 =W
170 =====
180 DATA BACK, FORWARD, LEFT, RIGHT, ""
    
```

See pages 75-79

VIII

● Program 7. Multiple printing with Wordwise, by Jonathan Evans

```

>VDU1,27,1,69
>LIST
10REM UTILITY TO PRINT MULTIPLE           160*FX15,1
20REM COPIES FROM SPOOLED                170REPEAT UNTIL GET=32
30REM WORDWISE FILES                     180F=OPENIN(N#)
40REM BY JONATHAN EVANS                  190KOUNT=0
50REM                                     200REPEAT
60REM FOR SERIAL PRINTER ENTER *FX      210A%?KOUNT=BGET#F
70REM COMMANDS AS APPROPRIATE           220KOUNT=KOUNT+1
80DIM A% 20000                            230UNTIL EOF#F
90MODE7                                    240CLOSE#F
100REPEAT                                  250FOR I=1 TO N%
110CLS:INPUT"Enter name of file to be    260VDU2
printed"or type END ";N#                 270FOR J=0 TO KOUNT
120IF N#="END" THEN MODE7:END            280PRINT CHR$(A%?J);
130INPUT"How many copies do you requi    290NEXT J
re ";N%                                    300VDU1,12
140IF N%>10 PRINT"Are you sure you wa    310REM THE ABOVE SENDS PRINTER TO TOP
nt that many?":REPEAT:G#=GET#:UNTIL G#=" 320REM OF FORM BETWEEN PRINTING OF
Y" OR G#="N":IF G#="N" GOTO 130          330REM EACH COPY. CHECK THAT CODE 12
150PRINT"Ensure that you have the cor    340REM IS CORRECT FOR YOUR PRINTER
rect disc"or tape in position and that    350NEXT I
printer"is switched on and at 'top of    360VDU3
form'."Press SPACEBAR to start."        370UNTIL FALSE

```

● Program 8. Saving text for View, with each line formatted automatically, by Bernard Wilson

```

>LIST
10 REM ***** VIEW3/7 *****
20 REM **** B.WILSON (C) ****
30 REM *****
40 CLS
50 REPEAT
60 PRINTTAB(2,5);CHR$(141);CHR$(131);"VIEW Text File Transfer Utility"
70 PRINTTAB(2,6);CHR$(141);CHR$(131);"VIEW Text File Transfer Utility"
80 PRINTTAB(0,12);CHR$(141);CHR$(133);CHR$(136);"Edit & Format after loading
to VIEW"
90 PRINTTAB(0,13);CHR$(141);CHR$(133);CHR$(136);"Edit & Format after loading
to VIEW"
100 PRINTTAB(2,17);CHR$(131)"Press TAB to Terminate and SAVE"
110 PRINTTAB(2,21);CHR$(131)"Select MODE 3 or MODE 7 ?...":G#=GET#
120 UNTIL G#="3" OR G#="7"
130 mode=VAL(G#)
140MODEmode:N%=HIMEM-LOMEM-124:*FX11,0
150DIM B% N%:P%=B%:L%=0:@%=5:C%=&C00
160 PROCbytesleft
170 REPEAT
180 G#=GET#
190 PRINTG#;
200 IF G#=CHR$&7F THEN P%=P%-2 ELSE #P%=G#
210 IF G#=CHR$&D THEN PRINT
220 P%=P%+1:N%=N%-1
230 IF mode=3 AND POS=79 THEN PROCCR
240 IF mode=7 AND POS=39 THEN PROCCR
250 UNTIL G#=CHR$9 OR N%<255
260 $(P%-1)=CHR$&D
270PRINT"Name of text file to be written ";
280INPUT #C%:IF #C%="" THEN #C%="TEXT" ELSE #C%=LEFT$(#C%,6)
290#C%="SAVE "+#C%+" "+STR$~B%+" "+STR$~P%
300 PRINT'#C%':X%=0:Y%=&C:CALL &FFF7
310MODE7:*FX12,0
320END
330 DEFPROCCR
340 M%=P%
350 REPEAT:M%=M%-1:VDU127:UNTIL ?M%=&20
360 ?M%=&D
370 vpos=VPOS
380 PROCbytesleft
390 PRINTTAB(0,vpos)
400 PRINT$(M%+1);
410 ENDPROC
420 DEF PROCbytesleft
430 PRINTTAB(0,1)N%" bytes remaining. "
440 ENDPROC

```

Program 1. Setting up and demonstrating program for slow-speed operation of the BBC micro (enter it with PAGE = &2000)

```

10 PROCassemble
20 PROCinit
30 REPEAT
40 A$ = GET$
50 A = ASC(A$)
60 IF A = 0 VDU 0
70 IF A>47 AND A<56 MODE A-48:A = 0
80 IF A$ = "T" PROC_T_window:A = 0
90 IF A$ = "G" PROC_G_window:A = 0
100 IF A$ = "F" PROCfill:A = 0
110 IF A$ = "W" PROCwait:A = 0
120 IF A$ = "Z" MODE 6:PROCzero_page_map:
    A = 0
130 IF A VDU A
140 UNTIL0
150 END

170 Interrupt Routines
180 *****
190
200 DEF PROCassemble
210 IF ?&FE62 = 1 CALL Z%
220 oldIRQ1V = !&204 AND &FFFF
230
240 FOR N% = 0TO2 STEP 2
250 P% = &D00
260
270 COPT N%
280 NOP:NOP:NOP \ NMI Routine
290 NOP:NOP \ *****
300 NOP:NOP
310 RTI
320 ]
330
340 P% = &C00
350 COPT N%
360 .IRQ1V
370 \ *****
380 BIT &FE60
390 BVS pb7 \ PB6 pressed?
400 LDA #0
410 STA &FE60 \ Switch pulses ON
420
430 LDA #&FF
440 STA &A80
450 STA &A81
460 STA &A82 \ Make a white marker
470 STA &A83 \ visible on the bit map
480 JMP oldIRQ1V
490
500 .pb7
510 BMI no_key_pressed \ PB7 pressed?
520 LDA #1
530 STA &FE60 \ Switch pulses on
540
550 LDA #0
560 STA &A80
570 STA &A81
580 STA &A82
590 STA &A83 \ Remove white marker
600
610 .no_key_pressed
620 JMP oldIRQ1V
630
640 .on \ Change IRQ1 Vector
650 \ *****
660 SEI
670 LDA #IRQ1V MOD 256
680 STA &204
690 LDA #IRQ1V DIV 256
700 STA &205
710 CLI
720
730 \ initialise the VIA
740 \ *****
750
760 LDA #1 \ Set PB0 as O/P
770 STA &FE62 \ Data direction reg. B
780 RTS
790
800 .off \ Restore original IRQ1V
810 \ *****
820 SEI
830 LDA #oldIRQ1V MOD 256
840 STA &204
850 LDA #oldIRQ1V DIV 256
860 STA &205
870 CLI
880 RTS
890 ]
900
910 NEXT
920 ENDPROC
930
940 DEF PROCinit
950 ON ERROR PROCerr_handle:END
960 *FX12,2
970 REM increase auto-repeat
    speed
980 *FX16,0
990 REM ADC interrupts off
1000 CALL on :REM Enable
1010 Z% = off :REM To allow IRQ to be
    switched
1020 :REM off before re-assembly
1030
1040 *KEY 10 PAGE = &2000:MOLD:IM
1050
1060 CLS
1070 PRINT "Adjust speed of pulses."
1080 PRINT "Press PB7 when ready."
1090 ?&FE60 = 0 :REM slow down

```

Continued ▶

Program 3. Produces a display mimicking the effect when you run program 1 and clear the screen at slow speed. Press the space bar to start and stop the progress of the display

```

10 MODE0
20 VDU19;4;0;:REM If you like
    blue background
30 FOR M%=1TO80*32-1
40 PRINT "X";
50 NEXT
60 FOR M%=0 TO 255
70 FOR N%=&3000 TO &7F00 STEP 256
80 N%?M%=0
90 IF INKEY(0)>0 REPEAT
    UNTIL INKEY(0)>0
100 NEXT
110 NEXT

```

IX

See 'The Beeb in Slow Time', page 81

◀ Continued

```

1100 REPEAT
1110   PRINT"I";
1120   UNTIL (?&FE60 AND 1) = 1
1130 REM i.e. PB7 was pressed and IRQ
1140 REM routine has set PB0 to logic 1
1150
1160 CLS
1170 PRINT"Ready"
1180 ENDPROC
1190
1200 DEF PROC_T_window
1210 VDU28,10,25,70,10
1220 ENDPROC
1230
1240 DEF PROC_G_window
1250 VDU24,100;200;1100;900
1260 ENDPROC
1270
1280 DEF PROCfill
1290 D$ = GET$
1300 IF D$ = "A" PROCAlphabet:ENDPROC
1310 FOR N% = 0TO2556
1320   IF D$ = "R" VDU(32+RND(95)) ELSE PRINT D$;
1330   NEXT
1340 ENDPROC
1350
1360 DEF PROCwait
1370 REPEAT
1380   UNTIL (?&FE60 AND 1) = 0
1390 ENDPROC
1400
1410 DEF PROCzero_page_map
1420 VDU19;4;0;
1430 VDU23;12;0;0;0;
1440 ?&34E = 0
1450 VDU12,28,0,24,39,14,12
1460 ?&E00 = 13: ?&E01 = 255
1470 FOR I% = &E02 TO &1000: ?I% = 0:NEXT
1480 ENDPROC
1490
1500 DEF PROCAlphabet
1510 FOR N% = 1TO100
1520   PRINT"ABCDEFGHIJKLMNOPQRSTUVWXYZ";
1530   NEXT
1540 ENDPROC
1550
1560 DEF PROCerr_handle
1570 ?&FE60 = 1
1580 REPORT
1590 PRINT" at line ";ERL
1600 ENDPROC

```

Listing 1.

Acorn

```

10 REM *IEEE488 with string data output
20 M=&4000 :REM Set pointer to base address of array
30 progend%=?&71*&100+?&70 :REM Calculate data array end address
35 *IEEE :REM Call IEEE file
40 cmd%=OPENIN("COMMAND") :REM Open command channel
50 data%=OPENIN("DATA") :REM Open data channel
60 PRINT#cmd%,"BBC DEVICE NO",1 :REM Set device address of BBC computer
70 PRINT#cmd%,"CLEAR" :REM Intialise interface
80 printer%=OPENIN("4") :REM Set printer device address
90 PRINT#cmd%,"LISTEN",printer%,"EXECUTE" :REM Set printer to listen
100 REPEAT
110 M$=$M :REM Get data string from memory
120 PRINT#data%,M$ :REM Output data string
130 M=M+LEN(M$)+1 :REM Update pointer
140 UNTIL M>=progend% :REM Until end of data array
150 CLOSE#printer% :REM close printer channel
160 CLOSE#data% :REM Close data channel
170 CLOSE#cmd% :REM Close command channel
    
```

XI

Listing 2.

Acorn

```

10 REM *IEEE488 with binary data output
20 M=&4000 :REM Set pointer to base address of data array
30 progend%=?&71*&100+?&70 :REM Calculate end address of data array
40 *IEEE :REM Call IEEE file
50 cmd%=OPENIN("COMMAND") :REM Open command channel
60 data%=OPENIN("DATA") :REM Open data channel
70 PRINT#cmd%,"BBC DEVICE NO",1 :REM Set device address of BBC computer
80 PRINT#cmd%,"CLEAR" :REM Intialise interface
90 printer%=OPENIN("4") :REM Open printer channel
100 PRINT#cmd%,"LISTEN",printer%,"EXECUTE" :REM Set printer to listen
110 PRINT#cmd%,"WRITE BINARY",PROGEND%-&4000 :REM Set binary output
    and number of bytes
130 REPEAT
140 BPUT#data%,?M :REM Output data byte
150 M=M+1 :REM Update pointer
160 UNTIL M=progend% :REM Until end of data array
170 CLOSE#printer% :REM Close printer channel
180 CLOSE#data% :REM Close data channel
190 CLOSE#cmd% :REM Close command channel
    
```

Listing 3.

Cambridge Computer Consultants

```

10 REM Cambridge Computer Consultants IEEE488 data string output
20 M=&4000 :REM Set base address of data block
30 progend%=?&71*&100+?&70 :REM Calculate end address of data array
40 printer%=4:sec_add%=-1 :REM Set device primary & secondary address
50 PROCIEINIT(&FC20) :REM Initialise the interface
60 PROCIEWRIT(printer%,sec_add%) :REM Open printer channel
70 PROCIEPUTA(M, progend%-M) :REM Output data array from memory
80 PROCIECLR :REM Close channel, good housekeeping!
    
```

See 'Triple Test', page 155

Listing 4.

## Cambridge Computer Consultants

```
10 REM Cambridge Computer Consultants IEEE488 data byte output
20 M=&4000 :REM Set base address of data block
30 progend%=?&71*&100+?&70 :REM Calculate end address of data array
40 printer%=4:sec_add%=-1 :REM Set device primary & secondary addresses
50 PROCIEINIT(&FC20) :REM Initialise the interface
60 PROCIEWRIT(printer%,sec_add%) :REM Open printer channel
70 REPEAT
80 PROCIEPUTB(?M) :REM Output data byte
90 M=M+1 :REM Update pointer
100 UNTIL M=progend% :REM Until end of data
110 PROCIECLR :REM Close channel, good housekeeping!
```

XII

Listing 5.

## C.S.T. - Procyon

```
10 REM IEEE488 C.S.T. - Procyon data string output
20 M=&4000 :REM Set pointer to base address of data array
30 progend%=?&71*&100+?&70 :REM Calculate end address of data array
40 *IEEE :REM Call IEEE file
50 REPEAT
60 M$=$M :REM Get data string from memory
70 PRINT#4,M$ :REM Output data string
80 M=M+LEN(M$)+1 :REM Update pointer
90 UNTIL M>=progend% :REM Until end of data array
```

Listing 6.

## C.S.T. - Procyon

```
10 REM IEEE488 C.S.T. - Procyon data byte output
20 M=&4000 :REM Set pointer to base address of data array
30 progend%=?&71*&100+?&70 :REM Calculate end address of data array
40 *IEEE :REM Call IEEE file
50 printer%=OPENOUT"4" :REM Open printer channel
60 REPEAT
70 BPUT#printer%,?M :REM Output data byte
80 M=M+1 :REM update pointer
90 UNTIL M=progend% :REM Until end of data array
```



See 'Pixels on Paper' and 'A Dump in its True Colours', pages 163-167

XIII

```

10 REM *** C/EPAT ***
20 REM Hybrid program to dump all graphics MODEs in actual colour
30 REM on any printer with the ESCape L n1 n2 graphics facility
40 REM including EPSONS, STARS, CANONS, SHINWA, INFORUNNER etc
50 REM G.B.Hill September 1983
60 REM PROGRAM START
70 S%=&A00
80 ?&80=00:?&81=&0A: REM point to pattern
90 PROCcheck
100 IF NOT graphics THEN PRINT"Not a graphics MODE. Can't dump.":VDU7:END
110 PROCassemble
120 REM enable printer, and set linefeed (send ESC A 8)
130 VDU2,1,27,1,65,1,8
140 REM clear paper
150 VDU1,10,1,10,1,10
160 FOR X%=0 TO 1279 STEP 16
170 REM send bit code (ESC L 0 3 - 768 dots per line)
180 VDU1,27,1,76,1,0,1,3
190 FOR Y%=0 TO 1023 STEP 4
200 'Xlo=X%+Y%*&10000
210 CALL three_bytes
220 NEXT
230 VDU1,10
240 NEXT
250 REM reset linefeed and disable printer
260 VDU1,27,1,65,1,12,1,12,3
270 END
280
290 DEFPROCcheck
300 DIM user 3
310 A%=&87
320 'user=USR(&FFF4)
330 mode=user?2
340 IF mode>5 OR mode=3
    THEN graphics=FALSE ELSE graphics=TRUE
350 ENDPROC
360
370 DEFPROCassemble
380 osword=&FFF1
390 oswrch=&FFEE
400 pattern=S%
410 'pattern=&04010200
420 pattern!4=&07050306
430 pattern!8=&03020000
440 pattern!12=&07050501
450 S%=S%+16
460 Xlo=S%
470 Xhi=S%+1
480 Ylo=S%+2
490 Yhi=S%+3
500 logical=S%+4
510 value=S%+5
520 byte=S%+9
530 count_8=S%+12
540 mode=S%+13
550 S%=S%+14
560 FOR opt=0 TO 2 STEP 2
570 P%=S%
580 [OPT opt
590 \SUBROUTINES
600 \to calculate POINT(X,Y)
610 .point      ldx #Xlo MOD 256
620             ldy #Xlo DIV 256
630             lda #9
640             jsr osword
650             ldx #logical MOD 256
660             ldy #logical DIV 256
670             lda #&B
680             jsr osword
690             rts
700 \subroutine to print three prepared bytes
710 .print_bytes ldx #2
720 .loop       lda #1
730             jsr oswrch
740             lda byte,X
750             jsr oswrch

```

```

760             dex
770             bpl loop
780             rts
790 \increment X by 2
800 .inc_X2    clc
810             lda Xlo
820             adc #2
830             sta Xlo
840             lda Xhi
850             adc #0
860             sta Xhi
870             rts
880 \to calculate three bytes & print them
890 .three_bytes lda #8
900             sta count_8
910 .byte_loop  jsr point
920             lda value
930             and #7
940             tay
950             lda (&80),Y
960             ror A
970             rol byte
980             ror A
990             rol byte+1
1000            ror A
1010            rol byte+2
1020            lda user+2
1030            eor #0
1040            beq mode0
1050            lda &80
1060            eor #8
1070            sta &80
1080 .mode0     jsr inc_X2
1090            dec count_8
1100            bne byte_loop
1110            jsr print_bytes
1120            rts
1130 ]
1140 NEXT
1150 IF P%<>&A89 THEN PRINT""You must have made an
    error in the assembly language routine.
    ""Please check it.":VDU7:END
1160 ENDPROC

```

Listing 3. A 'universal' pattern dump for all graphics modes.

**Listing 4. Assembly language dump for Canon PJ1080A.**

```

10 REM MACCAN4
20 REM Copyright G.B.Hill
30 REM March 1984
40 REM Version 4
50 REM Prints all graphics modes using physical colour
60 REM Assembly language printer dump for CANON PJ1080A printer
70 REM with all slow subroutines removed
80
90 MODE7
100 REM Operating system addresses
110 oswrch=&FFEE
120 osasci=&FFE3
130 osword=&FFF1
140 osbyte=&FFF4
150 osangs=&FFDA
160 oscli=&FFF7
170 DIM user 3,cli 30
180 REM Locate program
190 PROCfiling_system
200 IF tape THEN base=&D00
210 IF disc THEN base=&A00
220 IF NOT (tape OR disc) THEN PRINT"Can't *SAVE, unrecognised filing system.":VDU7:END
230 S%=base
240 REM reserve space for jump
250 S%=S%+3
260 REM Set up constants and variables
270 REM Xlo,Xhi bytes of X coord: Ylo,Yhi bytes of Y coord
280 Xlo=S%:Xhi=S%+1:Ylo=S%+2:Yhi=S%+3
290 !Xlo=&03FF0000
300 REM logical is the byte where osbyte deposits the logical colour
310 logical=S%+4
320 REM value is the byte where osbyte deposits the physical colour
330 value=S%+5
340 S%=S%+9
350 REM Store starting coordinates for subroutine setzero
360 XYstore=S%
370 !XYstore=!Xlo
380 S%=S%+4
390 message=S%
400 $message="Only modes 1,2,4 and 5"+CHR$13+CHR$(7)
410 S%=S%+24
420 control=S%
430 $control=CHR$27+"r"+CHR$1+CHR$80
440 S%=S%+4
450 REM pass and cnt8 are counters, store is a byte to pass to the printer.
460 cnt8=S%
470 pass=S%+1
480 store=S%+2
490 !cnt8=&00000108
500 S%=S%+4
510 FOR PASS=0 TO 2 STEP 2
520   P%=S%
530   [
540   OPT PASS
550   \
560   \SUBROUTINES
570   \
580   \Reset X and Y to screen top left
590   \
600   .setzero      ldx #3
610   .pling         lda XYstore,X
620                   sta Xlo,X
630                   dex
640                   bpl pling
650                   rts
660   \
670   \Check current mode, if not graphics,
        issue error message and set carry flag.

```

**Listing 5. How long does a screenful take?**

```

10 REM Printer Benchmark
20 REM Time taken to print 25
   rows of 80 characters
30 VDU2,1,7,1,13
40 FOR I=1 TO 25
50   FOR J=1 TO 40
60     VDU1,42,1,120
70   NEXT
80   VDU1,13
90 NEXT
100 VDU1,7,1,13,3

```



See 'Pixels on Paper' and 'A Dump in its True Colours', pages 163-167

```

680 \
690 .modecheck   lda #887
700             jsr osbyte
710             tya
720             cmp #6
730             bpl wrongmode
740             cmp #3
750             beq wrongmode
760 .rightmode   clc
770             rts
780 .wrongmode   ldy #00
790 .msg         lda message,Y
800             jsr osascii
810             iny
820             cpy #24
830             bne msg
840             sec
850             rts
860 \
870 \ MAIN PROGRAM
880 \
890 .canon       jsr modecheck
900             bcc start
910             rts
920 .start       jsr setzero
930             lda #2
940             jsr oswrch
950 .scan       ldy #0
960 .ctrl       lda #01
970             jsr oswrch
980             lda control,Y
990             jsr oswrch
1000            iny
1010            cpy #4
1020            bne ctrl
1030 .line       ldx #X10 MOD 256
1040            \osword to get physical colour
1050            ldy #X10 DIV 256
1060            lda #809
1070            jsr osword
1080            ldx #logical MOD 256
1090            ldy #logical DIV 256
1100            lda #8B
1110 .onebit     jsr osword
1120            lda value
1130            \select the colour to be printed
1140            ldx pass
1150            \red on pass 1, green on 2, blue on 3
1160            dex
1170            beq this_colour
1180            ror A
1190            jmp rgb
1200 .this_colour ror A
1210            rol store
1220            rts
1230            \
1240            .incX2   clc
1250            lda X10
1260            adc #02
1270            sta X10
1280            lda Xhi
1290            adc #0
1300            sta Xhi
1310            .printchar   lda #01
1320                        jsr oswrch
1330                        lda store
1340                        jsr oswrch
1350 \
1360                        lda #8
1370                        sta cnt8
1380 \
1390 .eol                 lda Xhi
1400                    cmp #05
1410                    bne line
1420 .resetXhi          lda #0
1430                    sta Xhi
1440 \
1450                    inc pass
1460                    lda pass
1470                    cmp #4
1480                    bne line
1490 \
1500                    lda #1
1510                    sta pass
1520 \
1530 .eop               sec
1540                    lda Y10
1550                    sbc #04
1560                    sta Y10
1570                    lda Yhi
1580                    sbc #0
1590                    sta Yhi
1600                    lda Yhi
1610                    cmp #&FF
1620                    \Yhi goes negative at end of page
1630                    beq finished
1640                    jmp scan
1640 .finished          lda #3
1650                    jsr oswrch
1660                    rts
1670 ]
1680 NEXT
1690 IF P%<>base+256 THEN PRINT""You must
1700 have made an error in typing in the
1710 code. Please check and try again.
1720 ":VDU7:END
1730 REM set up jump
1740 base?0=&4C
1750 base?1=canon MOD 256
1760 base?2=canon DIV 256
1770 COM#="SAVE ""CANONPJ""+STR$~base+
1780 +100 ""+STR$~base
1790 PROCoscli(COM#)
1800 PRINT""SAVING DUMP""*";COM#
1810 END
1820 DEFPROCfiling_system
1830 X%=&80
1840 Y%=0
1850 AX=0
1860 !user=USRosargs
1870 tape=(?user=1 OR ?user=2)
1880 disc=(?user=4)
1890 ENDPROC
1900 DEFPROCoscli($cli)
1910 X%=cli MOD 256;Y%=cli DIV 256
1920 CALLoscli
1930 ENDPROC

```

## LISTINGS TO LISTEN TO

WE had a noisy postbag after our challenge to readers to invent simple routines that produced entertaining sound effects. Sadly, more than half of the programs didn't work! Here are our five winners, though, each of which earns a crispy blue note, as promised.

Two of them put a Sheene on their programming technique with a motorbike effect. Dunstable reader Robin Smith's program sets up a linear speedo on the screen to keep pace with the acceleration and deceleration, while Paul Riley's version kicks-starts and then works up through the gears. For the best effect, turn your computer chair around and straddle it.

Worcester must be one of the farthest points in England from the sea, which could be why S J Bates of that town sends a program so evocative of a holiday idyll. Pour yourself a Bacardi, close your eyes, and listen to the pounding surf...

From the sublime to the ridiculous with E R Osborne of Lowestoft's cheeky *Wolf Whistle*. And finally *The Tree* from Crispin Turville-Petre - mysteriously titled but mesmerising.

Any more?



```
10REM WOLF WHISTLE
20REM E.R. OSBORNE
30ENVELOPE 1,0,3,0,0,21,0,0,127,127,0,
-127,126,126
40SOUND 1,1,140,5
50SOUND 1,0,0,6
60ENVELOPE 1,0,3,-2,-2,18,18,18,127,127,
0,-127,126,126
70SOUND 1,1,140,10
```

```
10CLS
20REM**The Tree**
30REM** by Crispin Turville-Petre**
40REM** piano and organ music **
50ENVELOPE 1,12,-12,-36,-45,90,255,255,
127,-40,0,0,126,0
60ENVELOPE 2,11,-26,-36,-45,255,255,
255,127,0,0,0,126,0
70SOUND 1,1,1,1:SOUND 2,1,1,1
```

```
10REM** MOTORBIKE **
20REM** by Paul Riley **
30ENVELOPE1,1,3,0,0,7,7,0,126,0,0,
-126,90,100
40FOR I=1 TO 3
50SOUND0,1,63,12
60SOUND0,0,0,5
70NEXT
80SOUND0,-15,3,255
90A=INKEY(200)
100FOR G=1 TO 4
110READ S,F
120FOR J=S TO F
130SOUND 1,0,J,0
140A=INKEY(5)
150NEXT
160A=INKEY(40)
170NEXT
180A=INKEY(100)
190S=185
200FOR I=-15 TO 0 STEP .03
210S=S-.1
220SOUND1,0,S,0
230SOUND&10,I,3,100
240NEXT
250DATA 40,160,100,170,100,180,110,185
```

```
10REM ** MOTORBIKE **
20REM ** by R. Smith **
30MODE1
40VDU 19,3,2,0,0,0
50ENVELOPE 1,15,-20,-20,-20,4,4,4,126,0,
0,0,126,126
60SOUND 0,1,255,1
70PRINTTAB(0,4)"SPEED=: MPH"
80PRINTTAB(0,6)"0 10 20 30 40 50 60 70 80
90 100"
90 VDU4:PRINTTAB(10,10)"PRESS ANY KEY"
100*FX21,0
110IF GET
120PRINTTAB(10,10)" "
130FOR X=8 TO 250
140SOUND 1,0,X,1
150IF X>100 SOUND 0,1,7,1 ELSE SOUND 0,1,7,2
160PROCSPD(3)
170NEXT
180FOR X=250 TO 7 STEP -1
190SOUND 1,0,X,1
200IF X<100 THEN SOUND 0,1,7,2 ELSE SOUND 0,
1,7,1
210PROCSPD(0)
220NEXT
230 GOTO 90
240DEFFPROCSPD(C)
250VDU 5
260GCLO,C
270IF X*4>400 AND C=3 THEN GCLO,2
280IF X*4>850 AND C=3 THEN GCLO,1
290MOVE X*5-32,860:PRINT"="
300ENDPROC
```

```
10REM Sea-side by S.J. Bates
20ENVELOPE1,6,0,0,0,6,3,4,11,-2,0,-2,
126,75
30ENVELOPE2,4,0,-3,-2,3,3,21,50,-1,-12,
-2,126,126
40REPEAT
50wave=RND(3)
60SOUND0,1,wave+3,20
70length=RND(20)+40
80SOUND&1000,0,0,length
90IF RND(2)=2 PROCcry
100UNTIL FALSE
110END
120DEFFPROCcry
130num=RND(3)
140FORquill=1TOnum
150SOUND1,2,230,20
160IF num>1 SOUND2,2,215,25
170IF num>2 SOUND3,2,240,10
180NEXT
190ENDPROC
```

Paul Beverley's  
second probing  
into the inner  
workings of  
the BBC micro



81

# THE BEEB IN SLOW TIME

**L**AST month we looked at what the BBC micro is doing internally by using the 'bit-map' technique. This displays the lower part of the computer's memory on the screen, but many things happen so quickly that it is difficult to see what is going on – hardly surprising as the 6502 processor can execute up to a million instructions per second! A way is needed of slowing the whole thing down to the sort of speed a human being can appreciate. The most obvious way would be to slow down the system clock. Unfortunately, this is not possible because many functions of the computer depend on the internal clock, not least of which are the video system and the RAM.

Another technique is to generate a rapid succession of interrupts and spend so long servicing them that there is hardly any time left to do any normal processing. This is done by feeding a square wave into the NMI (non-maskable interrupt) input of the 6502 processor. Since we don't actually want to do anything in response to these interrupts, the service routine consists of a simple delay created by using a number of NOP (no operation) instructions.

The actual timings used in my prototype were as follows: interrupts were generated roughly every 15 micro-

seconds ( $\mu\text{s}$ ), the interrupt service routine takes  $7\mu\text{s}$  (seven NOP instructions), the time the system takes to respond to an NMI is  $3.5\mu\text{s}$ , and then to execute the RTI takes another  $3\mu\text{s}$ . Thus there are only about  $1.5\mu\text{s}$  out of every 15 left for the processor to do its own processing. The actual timings can be adjusted by changing the number of NOPs and by altering the frequency of the square wave with a variable control.

A mere  $1.5\mu\text{s}$  processing out of every 15 suggests the system should work at about one-tenth normal speed, but in

**'A way is needed of slowing the whole thing down to the speed a human can appreciate'**

fact it is much slower because the normal IRQ interrupts on which it depends are still coming at the same rate as before and still take the same number of cycles to be serviced. This then takes up a much higher proportion of the available processing time. (In program 1 on yellow pages ix and x, I

have suggested that the ADC interrupts be switched off to reduce the number of IRQs and hence the likelihood of a system crash.)

You may wonder what happens when an instruction is being executed which needs more than three cycles of processor time ( $1.5\mu\text{s}$ ). When an NMI occurs, the processor always finishes off the instruction it is executing before starting the service routine, so, if a six-cycle instruction is being executed, by the time the processor has finished it and dealt with the NMI, there is zero time before the next NMI occurs, in which case it cannot do another instruction until the end of the succeeding NMI routine. If the NMIs come too rapidly, the system cannot cope and the stack becomes corrupted, rendering the machine inoperable. The only way out then is to press the break key. The hardware is arranged so the pulse generator is disabled when break is pressed because it is when the PB0 line is low that the generator is enabled; but when the VIA is reset, PB0 becomes an input and hence the pull-up resistor has the effect of making the external circuit register a logic 1, ie fast speed.

Figure 1 overleaf shows the simple circuit used. It consists of two chips – a 7413 Schmitt trigger circuit which produces the square wave pulses, and a

# Disc Doctor

£33.35 incl.

DISC DOCTOR is a general purpose utility ROM which adds 20 new commands to the BBC Micro. Most of these are concerned with disc operation although some of the commands are general purpose.

The extensive range of disc commands include a disc search routine and a very easy to use sector editor which allows any sector to be examined and changed if necessary. The built-in formatting command has a special option allowing dual catalogues on each side of the disc, so that up to 60 files per side may be used - almost twice the normal limit.

\*RECOVER and \*RESTORE commands are provided to help in the restoration of deleted or partially corrupted files. Any area of the disc may be transferred to memory, altered and \*SAVEd or \*RESTOREd back onto the disc. These commands prove invaluable when hours or even days of work are accidentally lost.

Many disc users often encounter the frustration of programs originally designed for use on cassette and require relocating to operate on disc. Disc Doctor provides commands to help with the transfer. \*TAPEDISC and \*DISCTAPE provide a simple means for automatically transferring non-protected files between tape and disc. Once programs are on disc, there are several relocation functions available. \*MOVE will move a program from one page in memory to any other. \*DOWNLOAD will load the program from disc and automatically move it to a specified position. \*MENU is more comprehensive still, offering a menu of programs available and allowing single key-press selection of any one. The chosen program is then loaded, re-located if necessary and automatically executed, whether BASIC or machine code.

General purpose commands include: \*DIS - which will disassemble an area of memory, following or skipping jumps, adding an offset, disassembling an instruction at a time or disassembling continuously.

\*MSEARCH - to quickly locate any string of bytes in memory, specified either as a character string, numeric values of a mixture of both.

\*MZAP - a very easy to use memory editor, allowing the user to scroll quickly up/down memory. It can be called from other programs to examine memory, then return to the program.

\*EDIT - will list any or all of the function key definitions, so that the user may edit and copy them.

The DISC DOCTOR ROM contains a full help menu listing all the commands and their syntax for quick reference. A spiral-bound manual gives general information about discs and describes each of the commands in detail, with examples. Easy-to-follow fitting instructions are supplied, allowing the ROM to be easily fitted by even the inexperienced user.

```
DISC DOCTOR 1.09
DIS <<sta>> <<end>> <<ofs>>
DISCTAPE <afsp> <<afsp>>...
DOWNLOAD <fsp> <<adr>>
DSEARCH <str> <trk> <<trk><sct><drv>>
DZAP <<trk>> <<trk><sct><drv>>
EDIT <<key no.>>
FIND <str>
FORM <drv> <no. trks> <<stt>> <<S>>
JOIN <fsp> <afsp> <<afsp>>...
MENU <<drv>>
MOVE <<dest page>> <<src page>>
MSEARCH <str> <<adr>>
MZAP <<adr>>
PARTLOAD <fsp> <ofs> <ext> <adr>
RECOVER <trk> <sct> <sct> <adr> <drv>
RESTORE <trk> <sct> <sct> <adr> <drv>
SHIFT <src> <dest> <ext>
SWAP <<drv>>
TAPEDISC <<fsp>>...
VERIFY <<drv>> <<no. trks>> <<stt>>
```

OS 1.20

Easy to Fit



# Graphics ROM

The GRAPHICS EXTENSION ROM brings 30 new powerful graphics commands to the BBC machine. The commands may be typed immediately or included within programs written in BASIC, BCPL, FORTH, etc. The commands act quickly (being machine code) and are always available without taking large amounts of program memory. The commands can be split into three categories:

### 1. Sprite Graphics

A sprite is similar to a user-defined character, except that sprites may be multi-coloured, several times larger (8x8 to 24x24 pixels in size), they are easily defined and altered with in-built commands and may be saved and later loaded. Sprites may be displayed and quickly moved around. Up to 32 different sprites may exist at the same time. 'Films' may also be created, in which any sprite is treated as a single 'frame'. Each time the 'film' is used the next 'frame' in sequence is automatically displayed, allowing simple animation of sprites. Any number of the possible 32 sprite numbers can be defined instead as a 'film' which may include a list of up to 47 'frames' in any order.

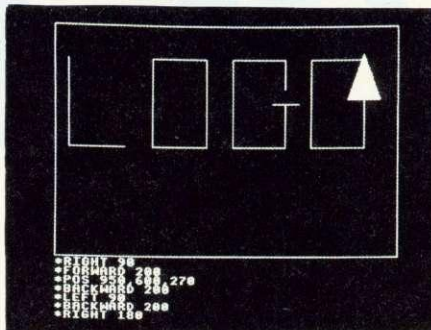

### 2. LOGO 'Turtle' Graphics

By using simple FORWARD, BACKWARD, LEFT and RIGHT commands a 'turtle' can be moved very quickly around the screen, producing intricate patterns by the most user-friendly means. The commands may be included in structured BBC BASIC programs providing a system faster and more powerful than many of the packages currently used to demonstrate LOGO turtle graphics.

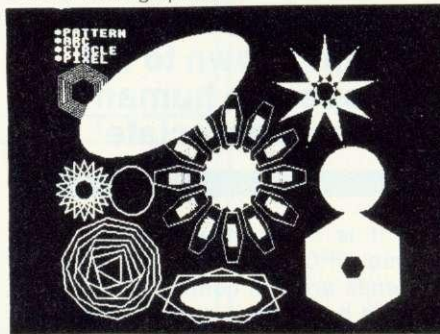

### 3. General purpose commands

- \* FILL will fill an intricate shape.
- \* CIRCLE provides fast and easy circle drawing.
- \* ARC fast easy arc drawing.
- \* PLOT provides 3D graphics drawing by plotting with X, Y, and Z co-ordinates.
- \* SCALE allows a scaling factor to be applied to everything subsequently plotted.
- \* ROTATE applies a rotation upon all subsequent standard PLOT, DRAW and MOVE commands so that they are rotated around any origin.

A built-in help menu showing the syntax of all commands is provided for quick reference. Included in the package is a comprehensive spiral-bound manual and step-by-step fitting instructions, suitable even for the inexperienced.

Further details available upon request.



£33.35 incl.



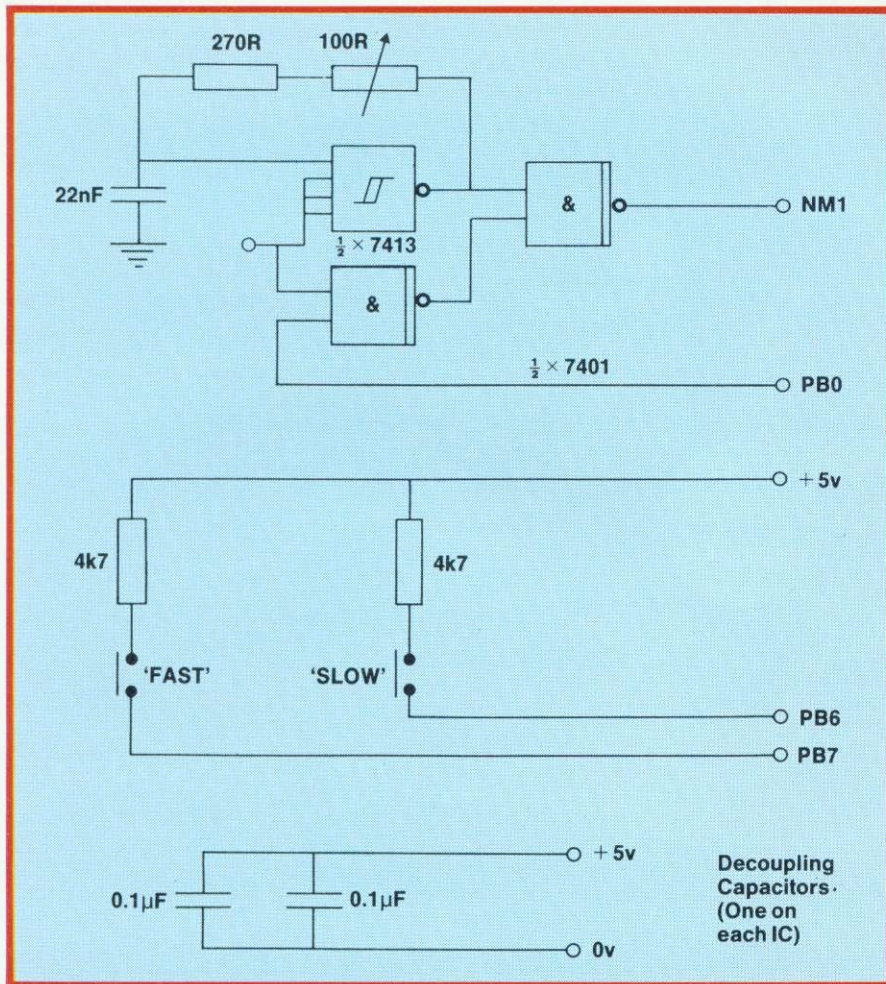

Figure 1. Circuit diagram for slow-speed BBC

7401 open collector NAND gate to enable you to switch the pulses on and off using one of the lines of the User Port (PB0). If you do not need the NMIs for anything else such as discs or Econet, you could make it even simpler by not bothering to use the open collector circuit and just driving the NMI line directly from the 7413. This works, but is not 'good practice', because you should only use open collector devices on the NMI line.

The circuit has to be connected to the micro through the user port. Unfortunately, although this provides almost all the lines needed, including the +5 volts supply, it does not give access to the NMI line. The only connectors on which this is available are the 1MHz bus and the disc interface, both of which use 34-way, IDC connectors. A 34-way connector and cable is expensive for just one line, so I suggest you solder a wire directly onto a component on the PCB (shock, horror!). You could solder to pin 3 or pin 8 of IC27 or direct to pin 6 of the 6502A. However, rather than solder directly to the leg of a chip, you can solder to the north end (ie nearest the back of the computer) of R81, the

3k3 pull-up resistor on the NMI line. This is situated along the west side of the 6502A. Unfortunately on earlier machines (up to and including issue 3) R81 is mounted vertically. Thus, if the resistor body is over the north hole, it makes it more difficult to get at something solderable. With a fine soldering iron, though, it should not prove impossible, and with issues 4 and 7 PCBs it is simplicity itself as the resistor is horizontally mounted.

One problem is that on some of the earlier machines there was a mistake on the printed circuit boards in the area of the NMI connection to the disc controller chip. This means that if you have an issue 1, 2 or 3 PCB and you are not already using disc or Econet, you would be well advised to check the voltage on the NMI line first. If it is less than 0.5 volts (ie logic 0) then you have problems and the safest way is to consult a dealer. One thing you could check though is that links S2 (Econet) and S9 (disc) are made with tinned copper wire and if they are not, then they should be fitted.

The only other hardware we are using is PB6 and PB7 for inputs to allow

us to signal the system to switch from slow to fast and vice versa. This is done because when the system is being fully stretched by the NMI interrupts, it often does not respond to the keyboard. Also, since we are using an IRQ routine to scan PB6 and PB7, the monitoring program does not need to be running to enable the user to switch speeds. Therefore, demonstrations can either be done using the main program or by typing in from the keyboard.

The program listing to run our little circuit consists of two main parts. The first contains the machine code routines for both the NMI and the IRQ interrupts. The NMI routine is a simple delay using NOPs, while the IRQ routine checks whether PB6 is grounded and, if so, switches to slow speed and, if PB7 is grounded, switches back to fast.

The second part is the Basic demonstration routines. These allow you to set up various test situations by single key presses. As you play with this system you will find other things to demonstrate and add to the program, but as it stands, the software sets up the following keys:

**0-7:** To switch between the different modes you can use the number keys, 0 to 7.

**F:** Pressing this key allows you to fill up the screen with characters. The key pressed after the F is the character used for filling the screen, except that pressing R produces a set of random characters, and A produces sets of the alphabetic characters.

**W:** This is a 'wait' function. It allows you to enter other keystrokes, but does not act on them until PB6 is pressed. In fact, it waits until the IRQ routine has responded to the pressing of PB6 and has set PB0 low. When you press PB6, the system switches to slow speed and the keyboard no longer responds, but the characters previously entered are already in the keyboard buffer and will therefore be acted on by the system at the slow speed.

**Z:** This key puts the micro into mode 6 and displays the bit map we discussed last month. However, doing so wipes out the program! Therefore you must enter or load the program at &2000 by setting PAGE = &2000 first. You should notice in this mode that as you switch from fast to slow a white marker appears and disappears in the middle of the screen.

**T** and **G** are used to define a text and graphics window respectively.

Here are a few other suggestions. The letters in quotation marks are the key-

page 87 ►

# LVL COMPUTERTOWN

Whether its your first computer or whether you're already an enthusiast, LVL COMPUTERTOWN offers you the quality of service you expect from experts. If you invest money, you go to a bank or a broker - a specialist who can guide and advise you on the best return for your capital. At LVL COMPUTERTOWN we're specialists too. We're there to help guide you through the micro maze, keep you up to date on innovations, help you get the best value for money, whether your computer is for you, your children or your business. Your computer can change your life - make sure you change it for the better: Come and talk to the experts and move into micros with LVL COMPUTERTOWN

## COMPUTERS



£199.00



The new personal computer from Acorn Computers. An ideal machine for learning computing - and for having a lot of fun at the same time. But it's much more than just a toy. It's graphic facilities are the most sophisticated available in it's price range.

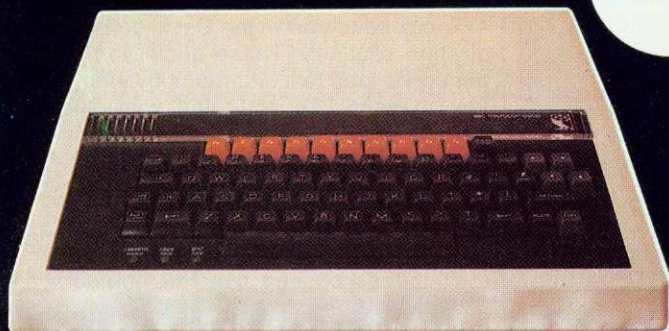

## BBC MICROCOMPUTER

MODEL A ..... £299      MODEL B with DOS .... £46  
 MODEL B ..... £399      Model B with DOS & ECONE ..... £51  
 MODEL B with ECONET £446

## MONITORS



### DECCACOLOUR

14" Colour Monitor

£247.25

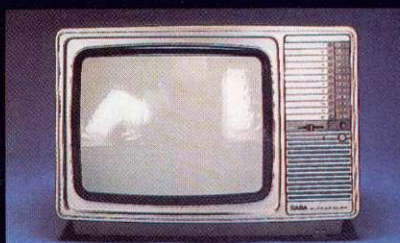

### SANYO

14" Colour Monitor/Colour

£274.4



### MICROVITEC

14" Colour Monitor

£247.25



### SANYO

12" Green Screen

£102.3

## PRINTERS

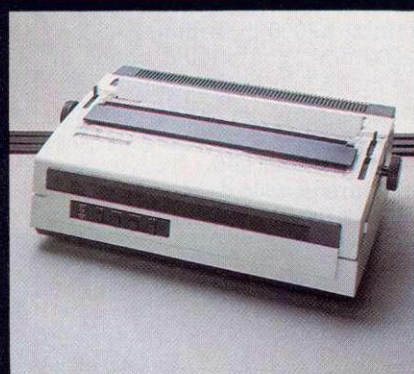

Seikosha GPI00A .....	238.05
Silver Reed EX500 Parallel .....	343.85
Silver Reed EX500 Serial .....	378.35
Silver Reed EX550 Parallel .....	534.75
Silver Reed EX550 Serial .....	569.25
Epson RX80 .....	320.85
Epson FX80 .....	503.70
Epson RX80 (F/T) .....	366.85
Epson MX100 (B2 Col) .....	546.25
Epson FX100 .....	654.35



# DATA RECORDERS



**A REFLECTION OF SUPERIORITY**

The Bell & Howell/LVL Computer Compatible Data Recorder

- Automatic Level Control
- Automatic Tape Stop
- Tape Counter
- Remote Motor Control

£ 39.95

# DISK DRIVES

An example of superior technology, total reliability and outstanding performance, combine to produce the LVL Disk Drive Family.

Truly professional units designed to work with the BBC Microcomputer.



CHECK OUT NEW LOW PRICES WITH YOUR NEAREST DEALER.

# SOFTWARE

## DESIGNED FOR THE BBC MICROCOMPUTER

ACORNSOFT GAMES

### Hopper

for the BBC Microcomputer Model B



## LANGUAGES

ASP	£16.85
ORTH	£16.85
AMES	
Monsters	£9.95
Hopper	£9.95
Planetoid	£9.95
Arcade Action	£11.90
Pocket Raid	£9.95
Meteors	£9.95
Arcadians	£9.95
Sliding-Block Puzzle	£9.95
Tube Master	£9.95
Warship Command	£9.95
Hooker	£9.95
Super Invaders	£9.95
Hopper	£9.95
Golditz	£9.95
Doctor Who	£10.00
White Knight II	£12.00
Missile Base	£9.95
draughts & Reversi	£9.95

## ADVENTURES

Philosophers Quest	£9.95
Castle of Riddles	£9.95
Countdown to Doom	£9.95
Sphinx Adventure	£9.95

## GENERAL

Desk Diary	£9.95
Creative Graphics	£9.95
Graphs & Charts	£9.95
Tool Box	£21.00
Record Keeper	£13.80
Magic Garden	£9.95

## EDUCATIONAL

Map References	£7.50
Lasermaths	£7.50
Classmaster	£20.00
Algebraic Manipulation	£9.95
Word Sequencing	£11.90
Missing Signs	£11.90
Number Balance	£11.90
Word Hunt	£11.90
Density Circuit	£11.90
Chemical Analysis	£13.80
Chemical Structures	£13.80
Jars	£11.90
Vu-Type	£16.10

ALL PRICES INCLUDE VAT.

The items featured represent a very small selection from our vast product range, and at the time of going to press were all available from stock.

However, not all dealers carry every advertised item, please telephone before making your journey.

Further information of both product and services available can also be obtained by telephoning or visiting your nearest LVL Computertown dealer.

## CHESHIRE

C-TECH SOFTWARE  
184, Market St.  
**HYDE**  
Cheshire  
061 366 8223

• COMPUTER CITY  
78, Victoria Rd.  
**WIDNES**  
Cheshire  
051 420 3333

## CUMBRIA

• THE COMPUTER SHOP  
56/58 Lowther St.  
**CARLISLE**  
Cumbria  
0228 27710

## ESSEX

A.C.L.  
1, Northmall  
**GRAYS, ESSEX**  
0375 79834  
BROADWAY MUSIC  
AND VISION  
Woodford Green  
**ESSEX**  
01 504 7500

## GREATER MANCHESTER

• LOMAX  
8, Exchange St.  
St. Annes Square  
**MANCHESTER**  
061 832 6167

## WORCS

SPURTREE COMPUTING LTD  
Temple Street,  
Council Buildings,  
**TENBURY WELLS,**  
Worcestershire  
0584 811353/811304

## MERSEYSIDE

• THORNGUARD  
46, Pensby Rd.  
**HESWALL**  
The Wirral,  
Merseyside  
051 342 7516

## NOTTS'

S P ELECTRONICS  
48, Linby Rd.  
**HUCKNALL**  
Notts.  
0602 640377

COMPUTERTOWN (UK) LTD.  
230, Derby Rd.,  
**STAPLEFORD**  
Notts.  
0602 399484

## OXFORD

ABSOLUTE SOUND  
AND VIDEO (Oxford) Ltd.  
19, Old High St, Headington  
**OXFORD**  
0865 65961

## AVON

K & K COMPUTERS  
32, Alfred Street,  
**WESTON**  
**SUPERMARE**  
Avon  
0934 419324

COLSTON COMPUTER  
CENTRE LTD.  
The Colston Centre,  
11, Colston Ave.  
**BRISTOL**  
0272 276619

## YORKSHIRE

HOME & BUSINESS COMPUTERS  
59, Daisy Hill  
**DEWSBURY**  
Yorks  
0924 485300

## WEST MIDLANDS

JBC MICRO SERVICES  
200 Earlsdon Ave.,  
Nth. Earlsdon  
**COVENTRY**  
0203 73813

## WILTSHIRE

WILTSHIRE MICRO  
CENTRE  
Unit 6,  
Central Trading Estate,  
Signal Way,  
Old Town,  
**SWINDON**  
0793 612299

## BUCKS'

HI-VU ELECTRONICS  
38, Church St. Wolverton  
**MILTON KEYNES**  
Bedford  
0908 312808

## SUSSEX

C J E MICROS  
78, Brighton Rd.  
**WORTHING**  
West Sussex  
0903 213900

## ISLE OF WIGHT

EXCELL  
4, Foreland Rd.  
**BEMBRIDGE**  
Isle of Wight  
098 387 2578

YOUR LOCAL



DEALER

## HEREFORD

KEMPSONS  
26, St. Owen St.  
**HEREFORD**  
0432 273480

## KENT

KENT MICRO  
57, Union St  
**MAIDSTONE**  
Kent  
0622 52784

## GRAVENSEND

COMPUTERS  
39, The Terrace,  
**GRAVENSEND**  
0474 90677

## LEICESTER

PERCY LORD & SON  
63, Blaby Rd.  
**WIGSTON**  
Leicester  
0533 785033

## LONDON

CANNONBURY RADIO  
185 Upper St  
**ISLINGTON N1**  
London  
01 226 9392

PAUL ELECTRICAL  
280/2, Grand Drive,  
Raynes Park,  
**LONDON SW20**  
01 542 6546

WOODS RADIO  
257, Lavender Hill,  
Battersea,  
**LONDON**  
01 228 1768

## SALOP

MEDLICOTT BROS  
53, Mardol  
**SHREWSBURY**  
Shropshire  
0743 3060

## SUFFOLK

S J EMERY & CO  
10, Market Place  
**BUNGAY,**  
Suffolk  
0986 2141

## IRELAND

EVERYMAN COMPUTER  
SERVICES  
**BALLYMONEY**  
Co-Antrim  
N Ireland  
026 56 62658

## STAFFS

I W BAGNALL  
18, Salter St.  
**STAFFORD**  
0785 3420

## KIRKLANDS

City Rd., Fenton  
**STOKE ON TRENT**  
0782 415787

• COMPUTERAMA  
59, Foregate St  
**STAFFORD**  
0785 41899

## SURREY

• HASLEMERE COMPS  
25, Junction Place,  
**HASLEMERE**  
Surrey  
0428 53850  
P & H ELECTRONICS  
5, The Parade,  
Reading Road,  
**YATELEY**  
Surrey  
0252 - 877 222

## LANCASHIRE

• P V MICROS  
38A Water St.  
**ACCRINGTON**  
Lancs  
0254 36521

• Home & Business  
Computers Ltd.  
54, Yorkshure Street,  
**OLDRAM**  
061 633 1608

• Home & Business  
Computers (RCH) Ltd.  
73, Yorkshure Street,  
**ROCHDALE**  
0706 344694

## WALES

S I R  
91, Whitchurch Rd.  
Cyncoed  
**CARDIFF**  
Wales  
0222 621813

THE COMPUTER SHOP  
41, The Hayes,  
**CARDIFF,**  
Wales,  
0222 26666

## SCOTLAND

COMMSCOT  
30 Gordon St.  
**GLASGOW**  
041 226 4878

## NORTH LAND

NEWTONS  
Main St.  
**SEABOUSES**  
0865 720307

# ACORN USER SOFTWARE

86

## FOR THE BBC MICRO AND ELECTRON ON DISC AND CASSETTE

Two quality, full colour games to test your skill, nerve and cunning.

Each £7.95 per cassette or £10.95 per disc (40/80 track).

Price includes VAT and postage.

Both games need OS1.0, or later, and 32k.

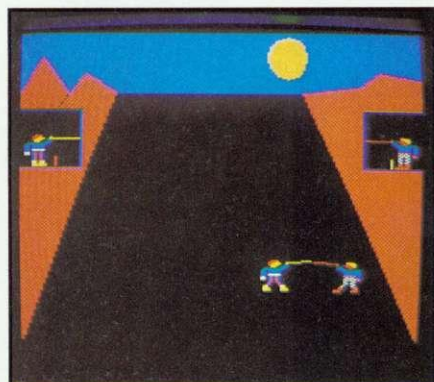

**SWORD MASTER** is one of the few two-player games around, and is designed for joystick or keyboard.

Sword Master by Ken Worrall is based on the fencing rules written in 1190 by Herman von Salza for the Deutschritter Order of Teutonic Knights. It features full-colour machine code animation of a sword duel between the players shown on screen as knights.

Full instructions, music, sound effects, player rankings (from Greenhorn to Swordmaster) and a roll of honour (which can be saved) are all included. The game also closely reflects the rules, style and dress of the Deutschritter Order.

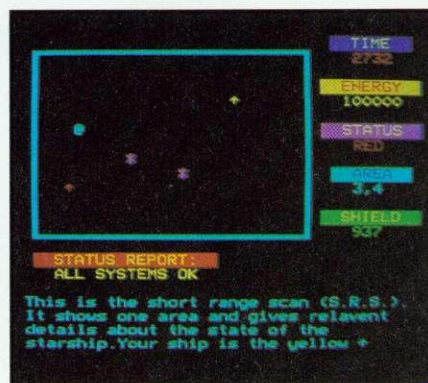

**TREK** was the first game to take advantage of voice synthesis on the BBC micro – and uses joystick or keyboard.

Trek puts you in charge of a Starship with the task of wiping out an alien fleet. It's an excellent adaptation of the classic game with 7 screen displays, 3 on-board computers and 2 weapon systems.

Versions have been written for BBC micro and Electron to use both machines to their full. The BBC tape uses voice synthesis (if the chips are fitted).

The game has been extensively developed from Tim Heaton's famous Trek III. It barely fits into 32k.

### DISC UPGRADE SERVICE

Return your cassette of Trek or Swordmaster, and we will exchange it for a disc (which will run on 40 or 80-track drives) for just £3.50. Please specify Amcom, Watford or Acorn DFS.

# PLUS

## ARTICLE LISTINGS ON CASSETTE

Yes, at last, the tape you've been crying out for! Save the wear on your fingers by sending for one of our cassettes giving all the major listings in this issue.

Each cassette costs £3.75 (inclusive) for the Electron and BBC micro. This includes a menu and disc transfer routine to help you find your way around – and use on your own programs.

The tapes come with BBC programs on one side and Electron programs as the other, so it shouldn't be possible to mix the two. Just turn to pages 177 and 178.

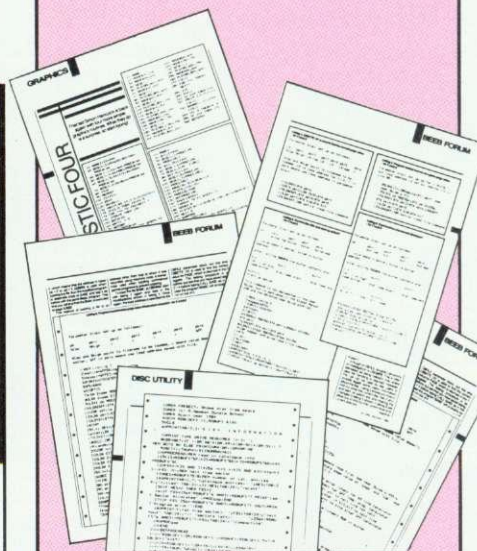

Save yourself  
the time and  
bother of typing  
in Acorn User  
listings

TURN  
TO  
PULL-OUT  
CARD  
PAGES  
177/178





◀ page 83

strokes needed to achieve the particular effect, and statements like 'CTRL - L' mean you hold the CTRL key down and press L. This produces a control code which, in the case of CTRL - L is 12 which clears the screen. After each combination of keystrokes, press PB6 to initiate action on those commands typed in after the W.

'0 F X W CTRL - L': Go into mode 0, fill the screen with Xs and then clear the screen. The screen is cleared neither from top to bottom nor from bottom to top, but by clearing the first byte of each page of memory, followed by the second byte of each page and so on. If you try CTRL - P instead of CTRL - L, ie do a CLG, you will see that it clears from the top down and, by comparison, takes a very long time. If you get tired of waiting, press PB7 and go back to full speed.

'0 F R W 7 0': Having filled the mode 0 screen with random rubbish you can, in slow time, watch it being cleared as mode 7 is selected. As it goes back to mode 0 it produces a very strange display in the interim, the screen splitting into four sections. This is presumably due to the processor re-programming part of the 6845 CRT controller, then working something else out, then finishing off the re-programming. The only explanation I have is that it may get held up as it tries to alter the C0 and C1 lines which changes the 'hardware wraparound' for the hardware scrolling. The internal VIA operates at 1MHz rather than 2MHz and therefore may be even more tied up by the excess NMIs. But that is only a theory.

If you want to see what is meant by 'hardware scrolling', go into mode 0, press escape and list the program. When the listing reaches the bottom of the page and is about to start scrolling, press PB6. You will see that each time

the screen scrolls, the top line appears momentarily at the bottom, is wiped out and then overwritten by the new line of text. If you try this again with a text window defined from within the program either by using T or by going into the zero-page bit map by using Z, you will see software scrolling. Starting from the top of the screen, each line is copied on top of the one above, the bottom line is wiped out and then the new line is written in. This is a laborious process and hardware scrolling does save a lot of processor time.

There are many things that can be done by using control codes. Page 507 of the *User Guide* will show you what they all are, but for example you could draw a filled triangle as shown in program 2.

Even if your machine uses disc or Econet, you will still be able to use these interfaces in the normal way as long as the pulses are switched off. The circuit is designed so that when switched to fast speed, the NMI line is available for normal use by other devices. It does not matter that you have over-written the NMI routines in PAGE &D00 since as soon as a disc function is called for, these routines are re-written into RAM by the disc filing system (I presume the same is true of Econet though I have not tried it).

A word of warning. It is possible to simplify the pulse circuit even more if you are prepared to disconnect the circuit manually before using the disc system. However, in the development stages I was doing just that, but on one occasion forgot to disconnect the pulses while trying to save the program onto disc. The result was a disc that was so badly corrupted that not only

was I unable to read track and sector using *Disc Doctor*, but what is more, when I had given up the idea of rescuing the other programs on the disc, I could not even get it to re-format without generating errors! In the end I had to wipe the whole disc with a tape-head de-magnetiser. That did the trick - I was then able to format it again.

This technique can also reveal an obscure design fault in the 6502 micro-processor. Apparently, if an NMI happens to arrive just as the processor is finishing off an IRQ service routine (during the last cycle of the RTI, I believe) it does not finish off the instruction properly, thereby corrupting the stack. The chances of this ever happening during normal operation of a 6502-based system is literally several millions to one against. However, because we are stretching the system to its limits, we should not be surprised if it hangs up on us occasionally. The remedy is simply to press BREAK, which is programmed to restore things.

If in using this method, you do discover anything of interest, or anything you do not understand, write to the Editor and let us know. We may be able to find an answer, and in any case it is interesting to have some feedback to let us know that people are actually using our project ideas.

*Next Month* we turn our attention to the random number generator that is contained within the Basic ROM. How does it work? How good is it? Can it be used from machine code programs? We will also be looking at a piece of simple hardware to go on the user port that will provide a high-speed supply of random numbers.

```

ctrl-P           (Clear the screen)

ctrl-Y           (= PLOT)

ctrl-@          (= PLOT 0 i.e. MOVE)

[or use ctrl-E (PLOT 5 i.e. DRAW)]

ctrl-@, ctrl-B (X co-ordinate = 512 = &20)

ctrl-@, ctrl-C (Y co-ordinate = 768 = &30)

ctrl-Y, U       (Draw a triangle = PLOT 85)

ctrl-@, ctrl-D (= 1280 = &40)

ctrl-@, ctrl-@ (= 0 = &00)
    
```

Program 2. Manual program for drawing a filled triangle

# 737 FLIGHT SIMULATOR

Written by a professional 737 pilot, this comprehensive simulator was originally designed as an aid to practice in instrument flying.

Performing to the specifications of a modern high performance jet airliner, the 737 Simulator was written specifically for the BBC Micro, and affords the following features:

- \* Accurate and detailed flight deck layout with both analogue and digital readouts.
- \* Colour Hi-res graphics and sound.
- \* Three-dimensional take-off and landing sequences.
- \* Radar plot of aircraft in mid-flight.
- \* Option of resetting stall speed, for beginners.
- \* Instrument Landing System (ILS) and Ground Proximity Warning System (GPWS).
- \* Simulated Engine Failure.
- \* Use of preset runway layout, or design your own.
- \* Set up your own atmospheric conditions (e.g. crosswinds).
- \* Accurate limitations and variations according to height and atmospheric conditions.
- \* Three radio navigation beacons.
- \* Flight Manual, including diagrams and a flying lesson.

Instruments include: ● Compass ● Artificial Horizon ● Altimeter ● Vertical Speed Indicator  
● Air Speed Indicator ● GWPS ● Radio Beacon Indicators ● ILS ● Engine Power Indicator ● Fuel Gauge  
● Stopwatch ● Flap Indicator

**Price £9.95**

Please add 50p p&p to all orders. Send A5 SAE for full catalogue.

Cheques or postal orders payable to:

# Salamander

## SOFTWARE

17 Norfolk Road, Brighton BN1 3AA

**Other titles available for the BBC Model B**

**EDG Graphics Package**

*A sophisticated technical drawing package.*

Tape Version £19.95

Disc Version £24.95

*All products compatible with all operating systems.*

**BBC Utilities Package:**

*Sound Shaper, EDG Epson Screen Dump, Teletext Screen*

*Editor, Disassembler.*

£9.95

**French Tutor:**

*Tests Vocab, speech idioms and irregular verbs; 1000 word vocabulary; full accenting capability; create your own files; progress assessment and revision list available at any time.*

£9.95

**NOW**  
Available on the ELECTRON  
and for the BBC on DISC



# BBC NEWS FROM DPL

## BBC COMPATIBLE FLOPPY DISC SYSTEMS AND DRIVES

- Case to hold one drive
- Ribbon cable to connect one drive to BBC Micro
- Power cable to power one drive from BBC Micro
- Switch on rear of case to select 40 or 80 TPI operation when using FD55E or FD55F.



- CASE to hold two drives (complete with blanking panel for use should only one drive be installed).
- Ribbon cable to connect **two** drives to B.B.C. Micro.
- Integral power supply for **two** drives.
- Switch on rear of case to select 40 or 80 TPI operation when using FD55E or FD55F.

### TEAC FD55 SERIES 5.25" 1/2 HEIGHT SLIM-LINE DISC DRIVES.

	Capacity	40TPI	80TPI	
FD55A	40 Track, Single Sided.	100K	N/A	£130
FD55B	40 Track, Double Sided.	200K	N/A	£180
FD55E	40 or 80 Track, Single Sided.	100K	200K	£155
FD55F	40 to 80 Track, Double Sided.	200K	400K	£218

THIS CASE CONTAINS ALL HARDWARE NECESSARY FOR TWO DRIVES. JUST SELECT ONE OR TWO DRIVES FROM THOSE SHOWN BELOW. IF YOU SELECT JUST ONE NOW, THE SECOND CAN JUST PLUG IN LATER. CASES ONLY SOLD WITH DRIVES.

£15  
HANDBOOK AND FORMATTING DISC

DELIVERY: Up to 28 days.  
WARRANTY: 90 days.  
TERMS: Strictly cheque with order.  
Send to P.O. Box 11, Stroud, Glos. UK GL5 1JN, or phone through your Access or Barclay Card number.

TO ORDER: ADD CARRIAGE/PACKING/INSURANCE AT £10 (COVERS NEXT DAY SECURICOR DELIVERY). THEN V.A.T. AT 15% TO TOTAL. THE ABOVE PRICES ARE VALID UNTIL END OF APRIL 1984.

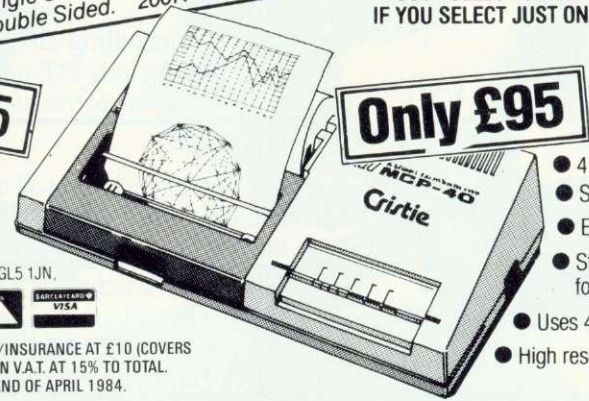

## PRINTER AND PLOTTER —MCP 40

- 4 colours
- Selectable 40 or 80 characters per line
- Easy to use—simple software commands
- Standard Centronics interface—cables available for most micros
- Uses 4 1/2" plain paper
- High resolution—over 100 steps/inch

ALL EX-STOCK

DIGITAL PERIPHERALS LTD.

Rodney House, Church Street, Stroud, Glos. U.K. GL5 1JN  
Tel: (04536) 71387. Telex 43551.

A **Cristie** Company

## CUBE/BBC SECOND PROCESSORS

As featured in Part 4 of BBC TV's "Computers in Control"

### EuroBEEB/EuroCUBE-65: 6502 Second/Independent Processor

EuroCUBE-65 is a 6502 multi-function SBC/CPU. It is both a second processor and a stripped-down industrial equivalent to the BBC Microcomputer.

EuroBEEB is EuroCUBE with 16kB BBC BASIC Interpreter ROM and 8kB battery-backed CMOS RAM memory on board.

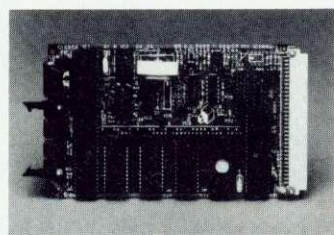

Features include:

- ★ Four RAM/ROM memory sockets, up to 16kB per device
- ★ Real-time clock
- ★ Battery back-up for CMOS RAM and clock
- ★ VIA providing 16 digital i/o channels
- ★ ACIA providing a bi-directional RS-423/422 serial port
- ★ The BBC Micro acts as an intelligent terminal/file server to EuroBEEB
- ★ Turnkey feature allows automatic power-up-and-run
- ★ CUBE bus connector for rack-mounting with peripheral Eurocards

From £167.00 ex. VAT

### CUBE BeebFLEX: 6809 Second Processor Unit

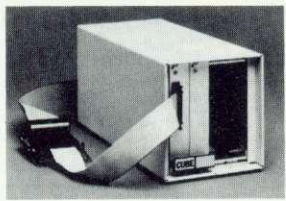

- ★ Fully supports the FLEX operating system on the BBC Microcomputer
- ★ Housed in self-powered beige metal enclosure with 2 spare CUBE Bus sockets
- ★ Wide range of software available to run under FLEX: macro-assemblers and cross-assemblers, compilers and cross-compilers, and high-level languages.

Supplied in 4-slot mini-rack with power supply, 64kB DRAM, supporting monitor ROM, CUBE BeebFLEX 'sideways' ROM, and TUBE interface.

£328.90 ex. VAT

Please ask for our new Catalogue which fully describes the CUBE range of 6502/6809 Eurocards. An explanatory colour leaflet on our CUBE/BBC Eurocard extensions is also available.

**Control Universal Ltd** Manufacturers of the CUBE Range of Industrial Microcomputer Systems  
Andersons Court, Newnham Road, Cambridge CB3 9EZ. Tel: Cambridge (0223) 358757, Telex: 995801 GLOTX-G.

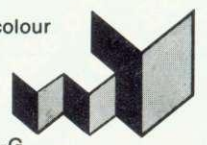

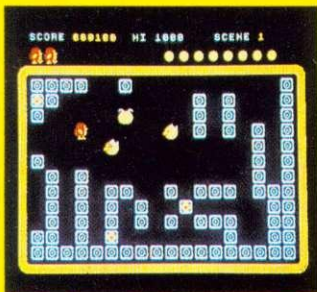

PERCY PENGUIN £7.95



COSMIC KIDNAP £7.95



SPITFIRE COMMAND £7.95



CHESS £7.95



HUNCHBACK £7.95



STAR BATTLE £7.95



BORIS IN THE UNDERWORLD £7.95

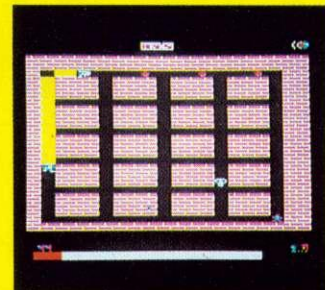

ROCKY £7.95

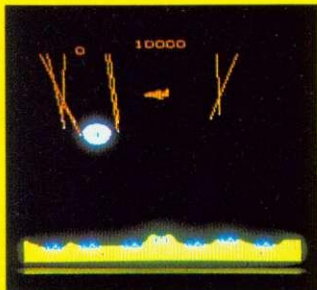

MISSILE STRIKE £7.95

**Boots** **BBC SOFTWARE**

**DEALERS...DEALERS...DEALERS**

Our software is now available at all good dealers including:  
 Selected branches of W. H. Smith, Boots, John Menzies, Rumbelows, Laskys, Currys, HMV, Greens at Debenhams, and Spectrum shops.  
 Also at all major computer dealers – Eltec Computers, Micro Management, West Coast Personal Computers, Microstyle, Electronequip, 3D Computers, Computerama, GTM Computers, etc. Our software is also available through all the major distributors, and directly from us by mail-order.



MOON MISSION £7.95



LADDER MAZE £6.95



STRANDED £7.95



MUTANT SPIDERS £6.95



GNASHER £6.95



NEUTRON £6.95



DARTS £6.95

**ALSO AVAILABLE:**

- OVERDRIVE £7.95
- BATTLE TANK £7.95
- STAR STRIKER £7.95
- MR. WIZ £7.95
- ROAD RACER £7.95
- FROGGY £7.95

**ALSO AVAILABLE:**

- CRAZY PAINTER £7.95
- 2002 £7.95
- CENTIBUG £7.95
- SPACE FIGHTER £7.95
- GALAXY BIRDS £7.95
- ALIEN DROPOUT £7.95

**ALSO AVAILABLE:**

- INVADERS £7.95
- FAIRGROUND £7.95
- FRUIT MACHINE £7.95
- STAR TREK ADVENTURE £7.95
- LOST CITY (ADVENTURE) £7.95
- GIDEON'S GAMBLE (ADVENTURE) £7.95

**ALSO AVAILABLE:**

- COLDITZ ADVENTURE £7.95
- PLANETARIUM £7.95
- DRAUGHTS £6.95
- REVERSI £6.95
- CRIBBAGE £6.95
- PONTOON £6.95

**SPECIAL OFFER! – DEDUCT £1 PER CASSETTE WHEN ORDERING 2 OR MORE.**



**SUPERIOR SOFTWARE LTD.**

Dept. AU7, Regent House,  
Skinner Lane, Leeds 7  
Tel: 0532 459453

**OUR GUARANTEE**

- (1) All our software is available before we advertise.
- (2) All our software is despatched within 48 hours by first-class post.
- (3) In the unlikely event that any of our software fails to load, return your cassette to us and we will immediately send a replacement.

# MY BLUE HEAVENS

Peter Vasey brightens  
up the background

92

**H**ere is a neat method for changing the background colour of the screen when running protected software. A frequent problem with commercial programs is that protection techniques prevent the user from changing features such as sound effects and colour. This short routine shows how the difficulties can be overcome.

Type in the program and save it onto disc or cassette without running it. Once you have done so press Break and then type MODE 5. Notice that the background colour of the screen has changed to blue.

To understand how it works, look at the listing once again. Line 110 sets the VDU vector at &20E,20F to point to the new routine. Line 130 then waits until the VDU drivers are sent the MODE 5 command. When this happens the machine-code equivalent of VDU 19,0,4,0,0,0 is executed (lines 150 to 180) and the VDU vector is then returned to its normal state (line 190). Lines 250 to 270 are included to allow disc users to auto-start programs with SHIFT/BREAK.

If you prefer another colour to blue, simply change the '4' in line 170 to the appropriate colour code.

This technique was originally designed for *Aviator* but it can be applied to most software and with a little modification more complex effects can also be achieved.

```

10 REM *****
20 REM BLUE HEAVENS! by Peter Vasey
30 REM *****
40 REM DISC/CASSETTE
50 REM Press BREAK to activate
60 REM for cassette version
70
80 FORN%=0T03STEP3
90 P%=&A00
100 [OPTN%
110 LDA#&B: STA&20E: LDA#&A: STA&20F
120 RTS
130 CMP#5: BNEnotyet
140 JSR&E0A4
150 LDA#19: JSR&FFEE
160 LDA#0: JSR&FFEE
170 LDA#4: JSR&FFEE
180 LDA#0: JSR&FFEE: JSR&FFEE: JSR&FFEE
190 LDA#&A4: STA&20E: LDA#&E0: STA&20F
200 LDA#247: LDX#0: JSR&FFF4
210 LDA#0
220 .notyet JMP&E0A4
230 J
240 NEXT
250 *FX247,76
260 *FX24B,0
270 *FX249,10

```

# STOP PRESS

## CUMANA PRICE LIST

Cumana BBC Microcomputer compatible disk drives:  
retail prices

Cumana disk drives supplied with formatting diskette, drive connecting cable and comprehensive user manual. Independent power supply, mains lead and moulded plug included.

CS100 Single 40 Track single sided	£169
CS200 Single 80 Track single sided	£209
CS400 Single 80 Track double sided	£233
CD200 Dual 40 Track single sided	£305
CD400 Dual 80 Track single sided	£386
CD800 Dual 80 Track double sided	£431
CD400/S Dual 80/40 Switchable single sided	£469
CD800/S Dual 80/40 Switchable double sided	£499

Cumana disk drives with independent power supply, mains lead and plug. Excluding other accessories.

CS100E Single 40 Track single sided	£159
CS200E Single 80 Track single sided	£199
CS400E Single 80 Track double sided	£219

Cumana disk drives supplied with formatting diskette, drive connecting cable and comprehensive user manual. Power supply taken from BBC Microcomputer with lead supplied.

CSX100 Single 40 Track single sided	£149
CSX200 Single 80 Track single sided	£199
CSX400 Single 80 Track double sided	£219

- ★ Top quality 5¼ inch TEC and Mitsubishi Japanese disk drives
- ★ Fully assembled and tested before packaging
- ★ 12 months warranty
- ★ Attractive hardwearing cabinets in BBC beige

Available from the following retail outlets:

W. H. Smith, John Lewis Partnership, Greens Leisure, Laskys, Spectrum UK

Area distributors:

HCCS Associates (Gateshead) 0632-821924, Eltec (Bradford) 0274-722512, Basic Business Systems (Nottingham) 0602-819713, Walters Computer Systems (Stourbridge) 03843-70811, Microage Distribution (North London) 01-205 7688, J. S. Simnett Computers (South London) 01-390 6161, Ferranti & Craig (Basingstoke) 0256-69966, Gwent Computers (Wales) 0633-859582, National Micro Centre (Stockport) 061-456 9548, Microworld (Edinburgh) 031-228 1111, Microtest (Cornwall) 0208-3171.

## REMEMBER...

+ National Dealer Network  
Please note: all prices exclude VAT and delivery charge

## ...THE BEST NAME IN MEMORY



## Print from Japan

## Disk Drives from Cumana

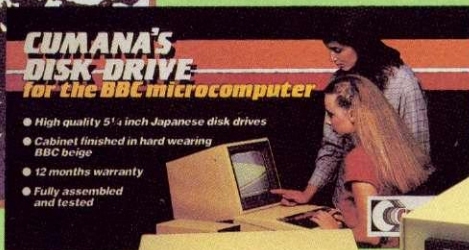

Like the beautiful prints from Japan, Cumana disk drives represent the very highest standards in design and production. Also like the prints, Cumana disk drives represent the highest state of the art; and they not only look beautiful, they perform beautifully as well.

Cumana disk drives for the BBC Microcomputer are available in slimline single, dual and dual switchable versions. They have 12 months warranty, are fully assembled and tested before packaging, and are available — at unbeatable value for money prices — from W. H. Smith, The John Lewis Partnership, Greens Leisure, Laskys, Spectrum UK, area distributors (see below) and Cumana's national dealer network.

Look out for the distinctive Cumana packaging in your high street, today!



*Area distributors:*

HCCS Associates (Gateshead) 0632-821924, Eltec (Bradford) 0274-722512, Basic Business Systems (Nottingham) 0602-819713, Walters Computer Systems (Stourbridge) 03843-70811, Microage Distribution (North London) 01-205 7688, J. S. Simnett Computers (South London) 01-390 6161, Ferranti & Craig (Basingstoke) 0256-69966, Gwent Computers (Wales) 0633-215008, National Micro Centre (Stockport) 061-456 9548, Microworld (Edinburgh) 031-228 1111, Microtest (Cornwall) 0208-3171, DRG Business Machines (Weston-Super-Mare) 0934-415398, Kingdom Design (Belfast) 0232-643720, Hugh Symonds (Bournemouth) 0202-26535, Audio & Computer Centre (Jersey) 0534-74000.

## The Highest State of the Art



Cumana Limited,  
Pines Trading Estate, Broad Street,  
Guildford, Surrey, GU3 3BH.  
Telephone: Guildford (0483) 503121.  
Telex: 859380.

For further information about Cumana disk drives for the BBC Micro, please complete and return this coupon.

Interests:

Home Use

Education

Dealer

Business

Name \_\_\_\_\_

Address \_\_\_\_\_

Tel. No. \_\_\_\_\_

AU7/84

Note: If dealer, please attach this form to your letterheading.

# ANNIVERSARY COMPETITION

94

THIS issue marks the second anniversary of the launch of *Acorn User*. To celebrate the event here is a special birthday quiz open to everyone to enter. It's designed to test your general knowledge of computing and computers, and almost all the answers to the questions have appeared in the pages of the magazine within the last two years. We're giving away no less than 20 first prizes of five packs of software (three for the BBC micro and two for the Electron), worth about £40. Ten runners-up will receive an *Acorn User* sweatshirt. See panel below for details.

- 1 What is the meaning of Basic?
- a) Just a nice name for a language designed to introduce newcomers to computers.
  - b) Beginners' All-purpose Symbolic Instruction Code.
  - c) Beginners American Standard Interface Code.

- 2 Was the first home computer in the UK to be sold at under £100:
- a) the ZX80?
  - b) the ZX81?
  - c) the Acorn Atom?



- 7 How much RAM does the BBC model A have?
- a) 8k
  - b) 16k
  - c) 24k

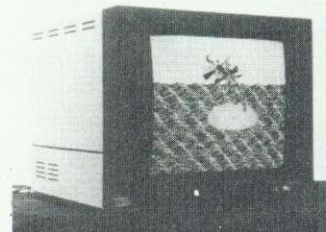

- 8 A colour monitor:
- a) checks that the high-resolution graphics on a computer are working?
  - b) gives a better picture than the average TV set?
  - c) enables you to use your computer to switch between different TV channels?

- 3 On a BBC micro how many elements are there in an array created by the Basic statement DIM A\$(20,2)?
- a) 40
  - b) 42
  - c) 63

- 4 On a BBC micro, is a bit:
- a) half a byte?
  - b) a binary digit?
  - c) one of the pins on a silicon chip?

- 5 Did the first issue of *Acorn User* appear in:
- a) January 1982?
  - b) July 1982?
  - c) November 1982?

- 6 Was the original name of the BBC micro:
- a) Quark?
  - b) Proton?
  - c) Neutron?



## HOW TO ENTER

Select your answers from the categories a, b and c in each question (for example 1a, 2c, 3b, etc), complete the 'tiebreaker' sentence and send your entry on a postcard to July Competition, *Acorn User*, 68 Long Acre, London WC2E 9JH to arrive not later than Friday, August 3, 1984.

## PRIZES

Each first prize will be made up of the top five packages listed in this month's software chart (see page 145): 'Snooker' (Visions) and 'Hopper' (Acornsoft) for the Electron, and 'Twin Kingdom Valley' (Bug-Byte), 'White Knight II' (BBCSoft) and '747 Flight Simulator' (Dr Soft) for the BBC micro. Ten runner-up prizes of an *Acorn User* sweatshirt will be awarded.

We regret that no correspondence or negotiation can be entered into regarding the competition or prizes – only postcard entries will be accepted.



- 9 Which screen mode in BBC Basic does the Electron not work in?  
 a) mode 0  
 b) mode 2  
 ✓ c) mode 7



- 10 Which of the following is an interactive or two-way system:  
 ✓ a) Prestel?  
 b) Ceefax?  
 c) Oracle?

- 11 *Snapper*, *Rocket Raid* and *JCB Digger* are all games written by Jonathan Griffiths. Who are the publishers?  
 a) BBC Publications  
 ✓ b) Acornsoft  
 c) Micropower



- 12 A modem is:  
 ✓ a) a device which enables a computer to communicate with another computer down a phone line?  
 b) a computer which runs full CP/M?  
 c) a computer which acts as a terminal to drive another computer?

- 13 ASCII means:  
 a) the second, upgraded version of the American Standards for Computers recommendations?  
 ✓ b) American Standard Code for Information Interchange?  
 c) a coding system based on the name of its inventor?

- 14 Sargon is:  
 a) an adventure game?  
 b) a chess program?  
 c) an interface?

- 15 In hex, B392 is the decimal equivalent of:  
 ✓ a) 45,970?  
 b) 43,298?  
 c) 46,026?

- 16 Charles Babbage's 'Analytical Engine' is:  
 ✓ a) a 19th-century forerunner of the computer?  
 b) an early computer developed at Manchester University around 1946?  
 c) A device which allows you to tune a car by means of a BBC micro?

- 17 In a standard flowchart for a program what does this sign (right) mean?  
 a) the beginning or end of the program  
 b) an input or output operation  
 ✓ c) a decision-making operation

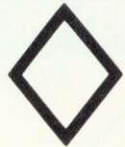

- 18 Information Technology Year was:  
 a) 1981?  
 b) 1982?  
 ✓ c) 1983?

- 19 Which one is Chris Curry?  
 Picture a  
 Picture b  
 Picture c



- 20 Complete in not more than 20 words the following sentence:  
 I like *Acorn User* because ...

## MARCH/APRIL COMPETITION WINNERS

HERE are the answers to the March and April competitions. Both involved putting up with the appalling Mad Alex – well, we all have to sometimes ...

In the **March** competition it was apparent to most of you that Alex had talked the most demented drivel. Those of you who weren't driven around the bend worked out that, yes, the kitty does

work and the highest value the coin could have would be 700 addisons and the lowest 27 addisons.

In the second part, the occupations of the four newly elected committee members were as follows:

- Anthony – Graphics consultant
- Bartholomew – Machine-code programmer
- Christopher – Designer
- David – Hardware expert

The winners, who each receive £20 worth of Acornsoft software, were M English of High Wycombe, Bucks; D Moore of Birkenhead; and F M Cameron of Hereford.

In the **April** comp the amount Alex owes you after your sojourn through the dungeon is 19,700 gold pieces (19,712 if you include your entry money). About half of you got this right.

The winners were Andy Cowan of Birmingham, David Westbrook of Oxford, and S Jhavar of Stockton-on-Tees. They have been sent £20 worth of Acornsoft software.

Those of you who continue to send in lengthy descriptions of Mad Alex's genetic make-up do so at your peril: rumour has it that he has perfected a technique of electrocuting his least favourite people over the telephone line. You have been warned ...

As usual, the best entry came from Frank Dashwood of Edinburgh, whose scribbles were composed on the back of an enormous poster advertising a wine called Bull's Blood – Mad Alex's favourite tippie!

For wit and humour beyond the call of duty we're awarding a special prize to Mr Dashwood – a fiver to buy himself a bottle of the red stuff.

# CHASE DATA

DFS KIT  
IN STOCK

## SLIM CANON DISC DRIVES:

MODEL:	SPECIFICATION OF EACH DRIVE
110	S/SIDED 40 TRACK 100K
210	D/SIDED 40 TRACK 200K
220	D/SIDED 80 TRACK 400K (40/80 TRACK SWITCHING)

■ All **CANON** 40/80 switchable disc drives feature an on-board dual-colour LED on the front panel to show track mode selected. This is coupled with our own unique two-stage illumination, to give a clear operating status, as follows:

40 TRACK MODE: \_\_\_\_\_ LED GREEN

80 TRACK MODE: \_\_\_\_\_ LED RED

POWER ON: \_\_\_\_\_ HALF-ILLUMINATION (GREEN OR RED)

DRIVE SELECTED \_\_\_\_\_ FULL-ILLUMINATION (GREEN OR RED)

■ Super-slim **CANON** drives, models 211 and 221 and the **SANYO** model 548S, are available with their own **custom-built secondary switching power supply**. This is safe, low in heat generation and excellent value for money.

■ The **SANYO** disc drive is our latest acquisition in quality Japanese products. This is a "half-height" unit of standard dimensions.

# LTD

# DISC DRIVES

**FOR THE  
BBC  
MICRO**

## SLIM SANYO DISC DRIVES:

MODEL: SPECIFICATION OF EACH DRIVE  
548S S/SIDED 40 TRACK 100K

## SUPER-SLIM CANON DISC DRIVES:

MODEL: SPECIFICATION OF EACH DRIVE  
211 D/SIDED 40 TRACK 200K  
221 D/SIDED 80 TRACK 400K  
(40/80 TRACK SWITCHING)

### All inclusive price list:

This means: disc drive + case + all power & data cables + U.K. carriage + utilities disc & manual + V.A.T.

MODEL:	CANON					SANYO
	110	210	220	211	221	548S
Formatted Capacity per drive on BBC Micro:	100k	200k	400k	200k	400k	100k
Single Drive & Case:	£149	£174	£209	£179	£236	£154
Single Drive & Case/P. Supply:	£174	£199	£234	£209	£266	£184
Dual Drive & Case:	£274	£324	£394	£329	£437	£284
Dual Drive & Case/P. Supply:	£299	£349	£419	£359	£467	£314
EPROMS 2764 (250 NS)						5.75 EACH

### Support:

**Warranty:** All disc drives sold by Chase Data Ltd. come with a full one-year warranty on parts & labour.

**Non-warranty service:** As THE experts in our field we can offer service on most makes of floppy disc drive.

**Recalibration & Alignment ...** £25 per unit inc. VAT. (parts extra). Phone for details: (Tel: 0784 38487)

### Payment



By Post: Send your remittance (cheques only please) with your order to:

## CHASE DATA LTD

P.O. Box 6, Woking, Surrey, GU21 4PB.

By Phone:  (Tel: 0784 38487).

# HARRIS McCUTCHEON SYSTEMS

are pleased to release

<b>HMS HOME ACCOUNTS</b> .....	<b>£28.75</b>
<b>HMS VAT TRADER'S LEDGER</b> .....	<b>£21.50</b>
<b>HMS BASIC ENVIRONMENT</b> .....	<b>£14.50</b>

to BBC Microcomputer users with a minimum configuration of 1 x 40 track single sided disc and an 8" 132-column (condensed mode) printer, to a maximum configuration of 2 x 80 track double sided disc and a 15" printer. The programs allow user allocation of each file between "DRIVE0, 1, 2 or 3, thus making full use of the disc space available.

HMS HOME ACCOUNTS allows all financial transactions within a defined environment to be recorded, printed and analysed. Accounts may be reconciled with statements or passbooks, unleared entries being highlighted. Depending on the analysis structure you choose, the system can keep track of anything from answering "how much is in the piggybank?" to independent tracking of multiple bank accounts, credit cards, building society accounts and cash in hand. The only reason for keeping home accounts in any form is to have your current financial state apparent on demand and reconcile statements received in order to find out where the money goes. This program is designed expressly for these requirements. You wouldn't keep them if these areas were of no concern, and being of concern you want to keep them thoroughly and effectively. HMS HOME ACCOUNTS allows this.

HMS VAT TRADER'S LEDGER, on the other hand, fulfills a different requirement. Instead of emphasizing analysis, the VAT trader wants to record all his invoices and bills in the least time possible consistent with making out the quarterly VAT return and getting a well-presented ledger listing on demand. Varying and multiple VAT rates are of course catered for. Add the facility to maintain period totals on user-defined bases other than VAT quarters (such as weekly, monthly and to the end of each trading account), and HMS VAT TRADER'S LEDGER should be a boon to you as a sole trader through to the low transaction company.

Both systems allow for 1000 to 10000 records per file depending on configuration and use, and initialise on shift-BREAK without user OS intervention. Fully documented source listings and optional user-modifiable VIEW text operating documentation are included on the master disc, and hard copy manuals are provided.

HMS BASIC ENVIRONMENT is specifically an aid to BASIC program development designed to encourage the creation of well-structured readable code in circumstances where memory becomes a constraint. Procedures to handlescreen /O, cursor switching, CLI invocation, and keyboard validation are provided, with a linking BASIC source-file compressor which includes variable name compression to two bytes. The ability to link as many BASIC source modules as desired into a single condensed running version resolves the coder's conflict between space and intelligibility; 60% compression is effected on our sources for the above accounts packages.

The disc, manual and information contained are sold under license subject to the condition that they are for single user single site application by or on behalf of the purchaser, are not for resale in whole or in part either as originals or copies, and may not be supplied to a third party as part of a package or used as part of a package supplied by a third party to the purchaser, without the written consent of the copyright holders. Damages will be claimed where this occurs, with revocation of license. Purchase indicates acceptance of license terms.

I enclose £..... for the following products (tick and delete where appropriate)

HMS HOME ACCOUNTS	(£28.75).....
HMS VAT TRADER'S LEDGER	(£21.50).....
HMS BASIC ENVIRONMENT	(£14.50).....

VAT, disc, manual, post and packing inclusive.

The credit card companies 4% take precludes our offering their service.

Please supply on 40/80 track disc. I have VIEW/WORDWISE; OS 1.0/1.2; BASIC I/II

Name.....

Address.....

..... Postcode.....

Telephone..... Date.....

Please send with cheque or postal order to: Harris McCutcheon Systems, 40 Huntingdon Street, London N1 1HM (01 609 3207)

# Micro Resources Limited

Southfield House, 11 Liverpool Gardens, Worthing, Sussex BN11 1RY  
Telephone: Worthing (0903) 213174

BBC Model B	£399.00
BBC Model B Disc Interface	£469.00
BBC Model B Econet	£446.00
BBC Model B Econet & Disc	£516.00
Acorn Electron	£199.00

## Acorn 6502 2nd Processor £199.00

This allows the BBC Model B to run faster with greatly increased memory especially in high resolution graphics modes, the package includes Tube software, the latest version of the DFS & NFS called DNFS, a Rom containing Hi-Basic and a comprehensive User Guide.

## Acorn Z80 2nd Processor £299.00

If you have wondered how to make the best use of your BBC for Business, then the Z80 2nd Processor and CP/M must be the answer. This package comes with a suite of business programmes, including Memoplan, Fileplan, Graphplan, Accountant, BBC Basic (Z80 Version), Cobal, Neculeus (Programming Aid), Professional Basic. This software alone is worth hundreds of pounds and with CP/M you can buy any of the programmes written for this operating system.

## Acorn Prestel Adaptor £99.00

Makes the BBC Micro into a Prestel Terminal revealing all the pages of information and allows you to use British Telecom Gold for electronic Mail etc.

## Acorn Teletext Adaptor £225.00

Allows the downloading, storing and running of programs via Ceefax, transmitted free of charge, pages can also be saved and printed from all 4 channels.

## Acorn Bitsik £375.00

This superb menu driven graphics package allows high quality CAD at a modest price. Needs 6502 2nd Processor and dual 80 track disc drives, a must for all design teams.

## Acorn IEEE 488 Interface £325.00

Provides computer control of compatible scientific and technical equipment. Useful in experimental work in industry and education.

## Acorn Word Processor View £59.00

This Rom based word processor has many advanced features including macros, still one of the best available on the market.

## Acorn Spreadsheet Viewsheet £59.00

A new spreadsheet from Acornsoft comes in a 16K Rom with a comprehensive manual, it is compatible with view and the 6502 2nd processor.



All prices include VAT and delivery

# THE MONEY PROGRAM I

John Vaux picks the Accountant out of the Z80 second processor bundle and renders this account

**T**HE Z80 second processor is a unit which connects to the BBC micro-computer via the Tube interface. The hardware and software was summarised last month, and this and subsequent reviews will concentrate on the software 'bundled' with the second processor. Bundled software is a new trend whereby programs are provided apparently free with an item of hardware. Nothing is really free of course, but if you add up the total normal price of the software it can come to a surprisingly high figure. If you have a use for the majority of it then it is well worth having.

Acorn's Z80 second processor comes with the packages listed in figure 1 overleaf, and the total value of all this lot if bought separately at retail prices would be over four times the price of the second processor!

The software comes on a total of seven discs, all fully documented in a set of matching manuals of very good quality. A special program called *Prepare* is provided to help you produce working copies of whichever programs you wish to use. This program is fully menu-driven with good prompts at all stages telling you what to do. If you generate all the software you finish up with 12 working discs. This program was quite impressive and augured well for the professional quality of the rest of the package.

## ACCOUNTANT

This month we look at the book-keeping program called *Accountant*, written by Compact Software International, which is well-proven on other Z80 business computers. It is a simple system based

on sales and purchase daybooks and a nominal ledger, from which a range of management reports can be obtained. Extra software can be bought to expand it at a later date to a full integrated accounts suite with sales ledger, purchase ledger and stock control.

The package lives on three discs: a start-of-day disc, main program disc and data disc. It runs on twin disc drives (2 x 400k), although if you have small data files it would be possible to run it on one drive. The system is started by inserting the start-of-day disc in drive A and keying in START. All this does is ask for today's date and then tell you to load the program disc in A and your data disc in B. The sequence seems a bit strange and got a bit annoying after a while. One could have expected this to be incorporated on the program disc, thereby saving a disc change.

## Nominal ledger set up

The first thing to do in any accounts package is set up a set of nominal codes in a logical manner to ensure the ability to produce meaningful management reports. This can be quite a problem for the beginner and it is therefore a pleasant surprise to find that *Accountant* has a sample set of codes already set up, which can be modified as required for your particular business. A full description of this excellent idea and an explanation of the code structure provided is in the manual. In fact, a full set of files is provided so you can dive straight into trying out the system. When you have finished getting to know the system these may be regenerated from the original discs using the *Prepare* pro-

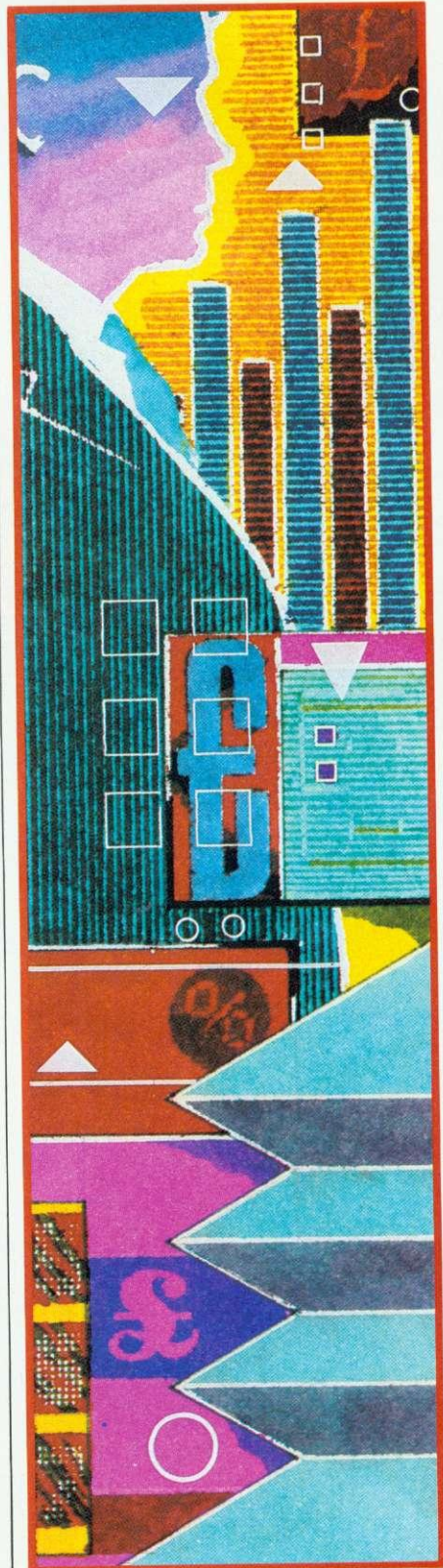

# 20,000K Winchester Disc for your BBC Micro

INTEC MAKES THE BBC REALLY COMPETE WITH  
SYSTEMS COSTING 2X AS MUCH!

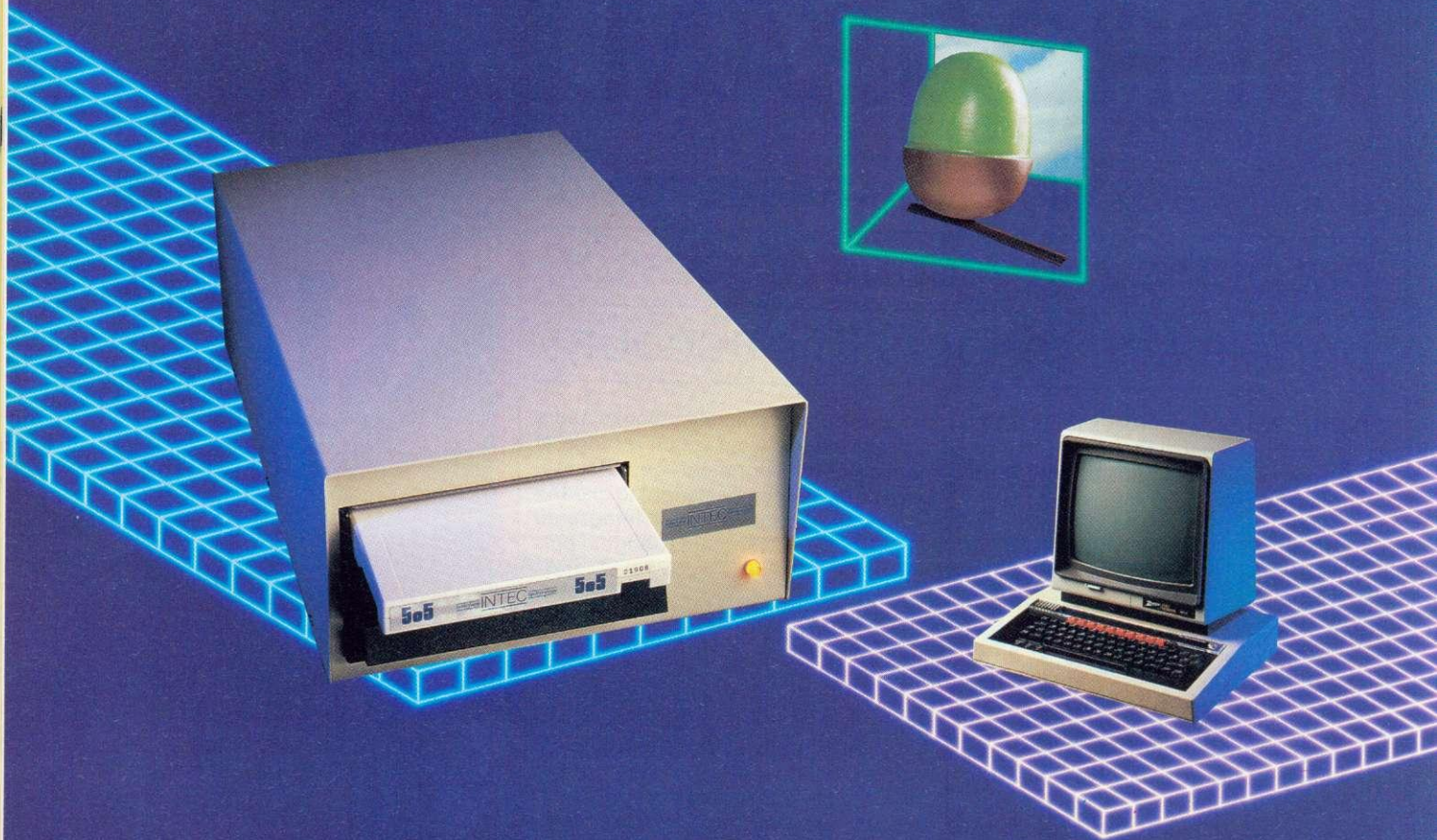

- ▶ Supports BBC and Acorn DFS.
- ▶ Full file handling and diagnostic software utilities.
- ▶ Data capacity from 5 Mb upwards.
- ▶ High speed accessing.
- ▶ UK manufactured.

The INTEC 505 gives all these benefits PLUS the removable hard disc cartridge providing a compact, secure and usable back-up or cartridge per application approach. Why pay more for less?

For full details on the INTEC range of hard discs for the BBC Micro, complete and post the tear-off slip or phone **INTEC now - 01-761 5999.**

**INTEC**  
41A-45 Knights Hill  
West Norwood, London SE27 0HS  
Telex 8813271 GECOMS G

**SEE US AT**

The 2nd  
Official  
Acorn User  
Exhibition

OLYMPIA  
16-19 AUGUST  
1984

INTERFACE TECHNOLOGY

# INTEC

Please Cut Out and Return  
**The INTEC Hard Disc Range**  
5-20 Mb Winchester and the fixed and removable 505.

NAME \_\_\_\_\_  
ADDRESS \_\_\_\_\_  
\_\_\_\_\_

BBC

gram or a blank set may be generated using an option in *Accountant*. If you try to do anything without having created any data files it soon tells you!

Certain nominal ledger control accounts must be present for the system to run. The codes for these must be entered on a control file which also contains your company details (name, address, etc.) and VAT codes and rates and your period end, year end and VAT dates. Facilities are also provided for entering budgets against nominal codes and also group codes for further analysis.

### Journal entries

Direct posting to the nominal ledger for such things as opening balances, petty cash, adjustments, etc, is done in batches using the 'journal entries' option. The batch technique enables easy checking that all entries have been made by reconciliation of a manually-calculated batch total with one generated by the computer. It also gives a better audit trail for checking by auditors or VAT men. A printed copy is always produced for any posting.

Taking the 'journal posting' option on the screen menu display brings up another screen for entry of the details. Entered dates are always checked for validity, and a check that entered nominal codes are on the file is made at time of entry. Amount entries are only allowed through if they are numeric.

At this point a slight criticism must be made. If you have made an entry and wish to change it, only the newly-entered characters are taken, even though the old ones are still displayed. For instance in a description, say the original entry was WWIDGETS and it should have been WIDGETS: when you key in the correction the field will show as WIDGETSS but will enter correctly. This is even more confusing in amount fields. Say you had entered 1000 and it should be 100. Values are moved to the right of the field by the system, so it will show as several blanks followed by 1000.00. When you enter your correction it will show as 1001000.00 - which it will correctly pick up. If you blank out the 1000.00 the system will reject the entry because it objects to blanks in numeric fields. It would be better if the field was cleared when you start entering new data, as it is in some cases when re-entering an invalid nominal code.

### Daybook entries

The 'purchase daybook' option handles purchase invoices, credit notes, cash purchases, and so on. Again, all input is

batched giving a check that all documents have been entered.

Defaults for dates, description and nominal code can be entered which will be offered as the value for each line and can then be changed if required. Net amount, VAT amount and gross amount must all be entered, although VAT is not calculated. Each item may be split across additional nominal codes if required. At the end of the batch the totals are checked. If they disagree you have the option to either correct the batch total, step through the items looking for the error, or abandoning the batch.

On acceptance the audit trail is printed and then the nominal ledger is updated with the details.

'Sales daybook' entries are made in a manner almost identical to those for the purchase daybook. One difference noticed is in the cash sales option. Here the system can be made to calculate the net amount from the gross by omitting the entry of a net amount.

### Reports

Several types of report can be generated, including:

- Account enquiry to show details of any nominal account and transactions.
- Trial balance with or without period balances.
- Transaction listing showing full details of all transactions for every nominal code.
- Budget/variance report showing performance against budget for current period and year-to-date. The variance is shown as pounds difference and also as a percentage difference.
- Formatted trial balance based on group codes.

## THE Z80 BUNDLE

- **CP/M operating system with the GSX graphics extension.** This is the standard operating system for eight-bit business micros and should give access to the enormous range of programs already available for that system provided they are made available on BBC format discs.
- **Z80 version of BBC Basic.**
- **Professional Basic** Similar to Basics from Microsoft and Digital Research.
- **CIS Cobol** Popular language for writing business software.
- **FilePlan** Card-index type system for storing data for rapid indexed retrieval.
- **GraphPlan** Financial modelling program or spreadsheet.
- **MemoPlan** Word processor.
- **Accountant** Book-keeping program.
- **Nucleus** Program generator.

Figure 1. Bundled software

After all reports for a month have been done, the month end routine must be run. This clears all individual transactions and carries the balance into the next month. At year end further balancing is performed and specified accounts set to zero.

### CONCLUSIONS

The whole program has been specially adapted for the BBC micro, and seven of the BBC's function keys are used. Luckily f9 is not included as this is adjacent to the break key - and inadvertently hitting that drops you out of the program and back to Z80 Basic. A book of function key strips is provided, one for each piece of bundled software.

The system is rather slow in operation. Loading a new program module in on changing a menu option takes from 10 to 30 seconds. Even passing from the heading level to item entry level on the screen takes about 30 seconds. Updating of the data files also is rather slow, typically about 20 seconds per item in a batch: as there can be up to 200 items per batch this could take a very long time. The conclusion is to keep batches small, say up to about 20 items.

Apart from deliberately hitting the break key, it was not found possible to 'crash' the system in normal operation. Ridiculous input such as wrong dates or enormous amounts were trapped with an appropriate message.

The documentation appears excellent on initial perusal. However, having read it from cover to cover it does not appear to be in the best logical order. The beginner will find himself hopping about from one chapter to another, and possibly not getting back to where he was.

The layout of the printed reports is very good. The main heading of each report is in wide print to make it stand out and pages are properly numbered with totals appearing where appropriate.

To place the above criticisms in perspective, this software is well up in the league of better accounts packages for microcomputers. It is obviously intended for the smaller business with not too many documents to be input as it is not one of the fastest systems for data input. Having got the data in, the enquiry and reporting facilities are fast and give very good information.

To summarise then, *Accountant* is well-written, well-documented and proven. If the rest of the software provided with the second processor is as good (and I know some of it is) then the total package is excellent value for money.

# How long have you waited for the right drive?

**PRICES REDUCED**  
 DOUBLE SIDED DRIVE NOW £219.99  
 SINGLE SIDED DRIVE NOW £179.99

*iscere et mirum*  
*discus*  
*discamen redue enim haec mo*  
*discus ictum redue.*  
*L. Da Vinci*  
*uis nostrud exertitation,*  
*discus et per interfacem. BBC micro.*

## THE FIRST CHOICE FOR THE B.B.C. MICRO

**THE UNIT** Precision engineered by Hitachi using tomorrow's technology today. Housed in a High Stability aluminium one piece casing for durability and smooth function. The case is finished in a tough epoxy coating which complements the BBC micro and other quality equipment.



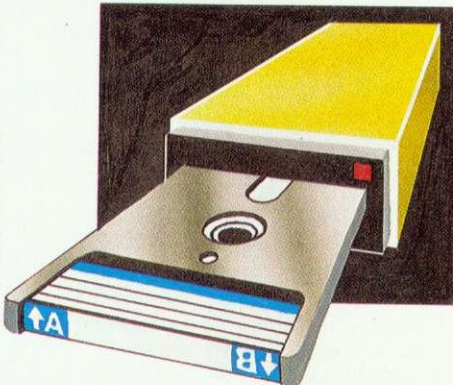

**COMPLETE PACKAGE** Supplied with data and power cables, utility disc, and instruction manual. Ready to plug in and use. Compatible with all known disc interfaces for the BBC micro. Powered by the BBC micro - no extra power supply required. 12 month parts and labour guarantee.

**THE MEDIA** The disc is encased in rigid plastic and the disc surfaces are protected by a stainless steel shutter which is automatically opened and closed by the disc drive.



**SPECIFICATIONS** Track to track access time is 3 ms. Data transfer rate 125 Kbs<sup>-1</sup>. Dual double sided Disc drives give 1 Megabyte of on-line storage.

### TERMINOLOGY GUIDE

-  A single sided drive accesses one side of a disc at a time.
-  Dual single sided drives access two sides at a time.
-  A double sided drive accesses both sides of a disc at a time.
-  Dual double sided drives access all four sides at a time. No need to turn discs over in double sided drives.
-  Unformatted capacity of one disc is 500K (double density), 250K (single density). Storage density is dependant on interface used.

**Please send me:**

- Single Disc Drive Double Sided Pack @ £252.00.
  - Double Disc Drive Double Sided Pack @ £491.50.
  - Single Disc Drive Single Sided Pack @ £195.85.
  - Double Disc Drive Single Sided Pack @ £360.60.
  - Pack of 5 3" Discs @ £22.50.
  - Pack of 10 3" Discs @ £41.00.
- All prices include VAT, post and packing.

*Generous Dealer Terms Available.*

Name \_\_\_\_\_  
 Address \_\_\_\_\_  
 \_\_\_\_\_  
 \_\_\_\_\_



**SPIDER SYSTEMS** Web House, 29 Elmfield Road, Stockport SK8 8SE. Telephone: 061-483 7692.



# MANAGEMENT BY MENU

Ian Rowlings test runs StarBase

'StarBase', GCC (Cambridge) Ltd, £69 (plus P&P)

**S**TARBASE is a ROM/disc-based data management system that is a truly professional tool. It is supplied with a 16k ROM, fitted in the usual manner, and a 40/80 track disc containing applications and extension software (51k). It is essentially menu-driven and makes extensive use of the function keys to provide the necessary functions. The manual is also comprehensive and explains not only how to use the system but also how it works.

Each file created can contain up to 4096 records. A record may consist of up to 69 fields, each of which can hold up to 255 characters of alphanumeric data. The maximum record size is 920 characters. The database capacity, that is to say the maximum file size, depends on the disc system used—a double-sided, 80-track drive will allow a file of 396k, almost full capacity; a single-sided, 40-track drive obviously allows proportionally less.

When you have formatted a disc to hold your database you are ready to start. Once you've mastered the structure of the system, its menus and function keys, it is easy to use. Calling \*STARBASE provides the initial menu:

```
C CREATE
F FILE
Q QUIT
```

Pressing 'C' provides the 'CREATE' menu:

```
<f0> Initialise disc
<f1> Build input form
<f2> Review disc
<f3> Re-date disc
<f4> Re-name disc
```

<f0> should not be confused with physical disc initialisation; it initialises the system and creates a file in the form you require. At this stage you are prompted for the user name, date and disc configuration, etc. You can also enter a password for security purposes. It can take a while to initialise and a useful tip is to \*BACKUP the disc after initialisation so that, without having to repeat the procedure, you have blanks available for future use.

<f1> provides a subsidiary level 2

menu which is used to design the record structure. Once construction is complete the file structure can't be modified. Other calls from this menu allow review of the file structure and certain minor modifications.

The second, level 2 menu accessed from the main menu is the 'FILE' menu:

```
<f0> INSERT
<f1> AMEND
<f2> DELETE
<f3> BROWSE
<f4> SORT
<f5> SHORT FORM
<f6> SELECT SUBSET
<f7> SAVE SUBSET
<f8> LOAD SUBSET
```

This is used for manipulating data once the file has been created. Each of these calls in turn provides, where appropriate and controlled by the function keys, the additional facilities that, once mastered, make the data management easy. All the normal functions you would expect of a professional system are provided, including useful additions to make the work quicker and easier. For example, calling <f5> allows you to select and thus restrict the fields on which the other functions are to work. It is surprising, given that you have a lot of work to do in particular fields, how much time this can save.

<f6> works in a similar manner, allowing you to restrict the work carried out on a subset of records of your choice, and provides the following Create Subset menu:

```
<f0> Finished
<f1> All records in file
<f2> No records (Clear)
<f3> Record by Keysearch
<f4> Add to subset from file
<f5> Select from Subset
```

When you select any of these you are prompted to enter the value or value and test condition by which the subset is to be defined. A wildcard facility allows selection of any specific value in any field. Such subsets may be manipulated with the other functions, including saving onto another disc. Sorting (descending or ascending) uses the Shell-Metzner method, which is very fast, and it can be based on the contents of up to five fields.

In addition to the facilities dealt with so far, there are other utilities and applications software on disc. Booting this provides the following menu:

```
A SBU01 Recover deleted record
B SBU02 Increment field
C SBU03 Field statistics
D SBU04 Configure printer
E SBU05 Print file review
F SBU06 Print record cards
G SBU07 Build print format
H SBU08 Print address labels
I SBU09 Print format
```

Option B allows you to increment or decrement the value of a particular field. The destination field need not be the same as the source field, and it can be used in conjunction with either numeric or alphabetic fields.

C allows you to calculate a total and average value of a specified field in a defined subset.

Booting the disc provides default settings for an Epson-type dot matrix printer. Calling D prompts for input concerning print formatting, enabling a variety of paper sizes and printer types to be used.

Utility E automatically prints most of the relevant statistical information relating to a file. F does as it says, also printing the field titles.

G is used before and in conjunction with H and I. It dictates the layout and contents of address labels, forms, letters and the like. The menu is:

```
1 Save form
2 Load form
3 New form
4 Edit form
5 List format
6 Print format
```

Selecting 3 provides yet another range of function keys to enable formatting, printer configuration and so on.

Utility H uses the predefined print format and allows you to arrange it in such a way as to suit a variety of labels—eg, which fields are to be printed and in what order.

I is similar to H, allowing formatting of invoices and forms.

The disc contains 21 further utilities which may be used at will and incorporated into your own programs. They provide useful functions relating to the manipulation of data and files, extracting and inputting data and statistical information and many more. Useful examples are included.

Because the system is menu driven and makes extensive use of the function keys it is flexible and easy to use. StarBase is adequately protected with suitable error messages. It is an exceptionally good package, and I believe it would compare favourably with similar products.

# COM-TEC COMPUTER CENTRE LTD



DEALER  
AND  
SERVICE  
CENTRE



DEALER

23 Sheffield Rd  
Barnsley  
South Yorkshire  
Tel: 0226 46972

Educational Orders Welcome

Discounts Available on Bulk  
Orders

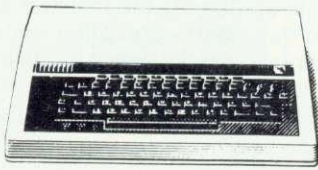

BBC Model B 399.00  
BBC Model B + Disk 469.00  
Electron (now in stock) 199.00  
Disk Interface Kit 101.00

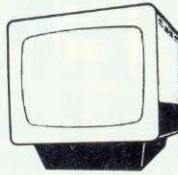

BNC Green Screen 113.85  
Mitrovitec 14" Cub 245.00  
Phoenix Green Screen 130.00  
BBC Monitor 99.00  
Amber Screen 135.00

## DISCS

(Scotch 3m)  
744 SS40 19.32  
745 DS40 27.95  
746 SS96 34.50  
747 DS96 46.25  
7440 Clean kit 19.50

## ROMS

Wordwise 45.00  
Disc Doctor 33.00  
Graphics Ext 33.00  
Print Master 33.00  
Caretaker 33.00  
ADE 60.00  
Spy 2 30.00

## SOFTWARE

Felix in Factory 7.95	Swoop 7.95
Martian Attack 7.95	Carm 7.95
Cybertron Miss 7.95	Chess 7.95
Hell Driver 7.95	Physics 6.95
Moon Raider 7.95	Where 6.95
Alien Swirl 7.95	World Geog 6.95
Laser Cmnd 6.95	Adventure 7.95
Danger UXB 7.95	Caveman Ad 6.95
Escape Mnbs 7.95	Fairground 7.95
Galactic Cmnd 7.95	Crazy Painter 7.95
Labryn Lacush 7.95	Lost City 7.95
Dambusters 7.95	Monaco 7.95
Lunar Rescue 7.95	Flexibase 9.95
Gideons 7.95	Alligatacalc 9.95
Gamble 7.95	

Order 1: deduct £1.00  
Order 2: deduct £3.00  
Order 3: deduct £6.00  
Order more than 3, deduct £2.00 per game.

## PRINTERS

Seikosha GP50A 138.00  
Seikosha GP50S 138.00  
Seikosha GP500A 228.85  
Seikosha GP550A 299.00  
Seikosha GP700A 458.00  
Seikosha GP250X 264.00  
Friction Feed GP100/250 28.00  
Epson RX80 310.00  
Epson RX80FT 356.00  
Epson FX80FT 431.00  
Star Gemini 10 x 280.00  
Star Gemini 15 x 400.00

4 Colour Plotter + BBC lead 129.95

## RIBBONS

Seikosha 4.99 Epson £5.74

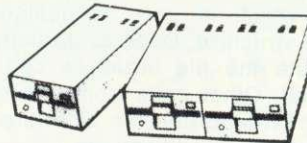

SD Single Drive DD Dual Drive  
SS Single Sided DS Double Sided

SD SS 40tk 100k 194.00  
SD SS 30tk 200k 253.00  
SD DS 40tk 200k 228.00  
SD SS 80tk 200k 221.00  
DD DS 40tk 400k 431.00  
DD DS 80tk 800k 511.00  
SD DS 40/80 310.00  
DD DS 40/80 534.00

All drives include leads, manual and utility disk

Torch Disk Pack 839.00

CARRIAGE FREE ON ALL ITEMS

Access and Barclaycards accepted  
Tel: 0229 46972

## DIGI-BOXES

Ideal for  
Robotics or  
Experimenters

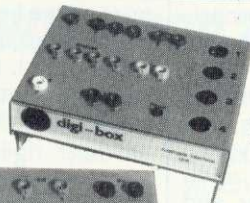
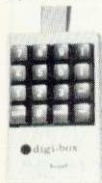

## IS YOUR MICRO IN CONTROL?

It could be  
with one of  
these  
(BBC Comp. only)

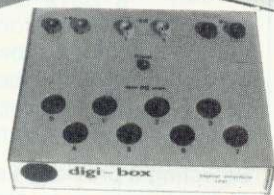

## CONTROL INTERFACES

(1) **MAINS CONTROL UNIT** - Enables the user under software control to switch 240v Mains appliances, up to 2.5Kw (10 Amp Max.). Uses latest technology Solid State Relay (Opto-Isolated, Zero Crossover). Neon indicator. Comes with cable for direct connection to Unit 3. Up to TWO units may be connected to Unit 3 or FOUR may be connected direct to the computer via the Unit 4 (see below).  
PRICE £35.95

Double Ended ribbon cable for direct connection of one mains unit to User Port. (Special low price hence not supplied separately)  
PRICE £2.99

(2) **ANALOGUE UNIT** - This unit brings out all 15 lines to enable equipment to be connected to the BBC Analogue Port using commonly available terminals (4mm Banana type). Also 4 x 2-pin (Channel + Earth) Din type sockets for experimental use. All terminals are Colour Coded (set of matching plugs supplied) and Numbered.  
PRICE £25.95

(3) **DIGITAL UNIT** - Enables connection to be made to the User-Port using commonly available terminals (4mm Banana type). Also All EIGHT Input/Output ports terminated in 2-pin Din type sockets. All terminals are Colour Coded (set of matching plugs supplied) and Numbered.  
PRICE £24.95

(4) **MAINS CONTROL 4-WAY ADAPTOR** - (not illustrated) This unit utilises the same ribbon cable used with Unit 1 to enable up to FOUR of the Mains Control Boxes to be linked to the computer User-Port.  
PRICE £16.95

**STOP PRESS** - 16-way Numeric Keypad (quality key switches) ALL keys fully programmable. Cased and complete with tape software driver plugs into user-port.  
PRICE £38.95



Accepted. To Order send Cheque/P.O. (or telephone Credit Card number to 0272-562741 (Not Wednesdays).

Please Add £1.50 p + p (any number of items) and 15% VAT to total.

INTERFACE COMPONENTS - 172, Burley Grove, Downend, Bristol,  
AVON, BS16 5QQ.

# BBC MODE 7 SCREEN DUMP

FOR EPSON MX-80 & FX-80 PRINTERS

Caters for:-

- \* All text & graphics characters
- \* Double & normal height characters
- \* Separated & contiguous graphics
- \* Graphics hold & release
- \* Black on white for monochrome graphics
- \* Grey tones for colour graphics
- \* Takes less than 80 seconds (FX-80)
- \* Large central printout (17cm x 14cm)
- \* Disk & tape versions on same cassette
- \* Includes programme for completing Prestel double height characters

Send cheque for only

# £4.50

To:-

T-SOFT  
38 The Crescent,  
Caddington,  
BEDS.  
LUL 4JA

Or call for further info & sample printout

Tel: Luton (0582) 37039

# Take Advantage of us!

**50 s/s d/d disks + box – £50 plus VAT + p&p**

**50 d/s d/d disks + box – £75 plus VAT + p&p**

DiscoTek sells disks and accessories, we'll sell them to practically anyone, anywhere. So when we got a telephone order for a lot of storage boxes and disks we didn't waste any time and stocked up. Then the order was cancelled. So we're having to let them go at cost, in fact, less than cost.

For just £50 we can supply a rigid, high impact plastic storage box, with four dividers packed with 50 single-sided, double-density disks. The same storage box filled with 50 double-sided, double density disks will cost just £75. And all carrying our five year guarantee – if a disk is faulty send it back for two free replacements.

To order just clip the coupon below.



To Disco-Technology Ltd,  
20 Orange Street,  
London WC2H 7ED 01-930 1612 (24 hours)

Please rush me \_\_\_\_\_ qty storage boxes filled with 50 single-sided   
50 double-sided  disks at £59.50 or £87.25 respectively.

(£2 already added for p&p and insurance) I enclose a cheque for £ \_\_\_\_\_

or debit my Access card No. \_\_\_\_\_

Name \_\_\_\_\_ Signature \_\_\_\_\_

Address \_\_\_\_\_

Postcode \_\_\_\_\_ Telephone \_\_\_\_\_

To Disco-Technology Ltd,  
20 Orange Street,  
London WC2H 7ED

**DISCO-TEK**  
COMPUTER PRODUCTS

# EPIC ADVENTURES PRESENTS WHEEL OF FORTUNE

## THE NEW GRAPHIC ADVENTURE FOR THE BBC

*"This has to be the adventure of 1984. It really is superb . . . . Epic should be proud."*

MICRONET 800

FULL MULTI-STATEMENT LANGUAGE INTERPRETER : INTELLIGENT MOVING CHARACTERS  
REAL-TIME ACTION : HALF-SCREEN GRAPHICS FOR EACH OF THE 250 LOCATIONS

**UNBELIEVABLE VALUE AT £9.95 + 50p P&P**

Please specify BBC or Electron – no graphics on Electron version

ALSO AVAILABLE: OUR POPULAR TEXT ADVENTURES FOR BBC AND ELECTRON

CASTLE FRANKENSTEIN  
*"... a substantial adventure with fast reaction times and a good screen layout."*

P.C.W. 16th Feb

QUEST FOR THE HOLY GRAIL  
*"... I found Holy Grail the most gripping tale and its construction is excellent . . . You've got to buy this one."*

Acorn User May 84

KINGDOM OF KLEIN  
*"An extremely good adventure and excellent value for money. Recommended."*

Electron User May 84

**ONLY £7.95 EACH + 50p P&P** (Please specify BBC or Electron)

POSTAGE FREE IF ORDERING TWO OR MORE GAMES

Please make cheques payable to: **EPIC SOFTWARE, Dept Au 1  
10 Gladstone Street, Kibworth Beauchamp, Leicester LE8 0HL**

ALL OUR GAMES ARE AVAILABLE FOR IMMEDIATE DESPATCH

*Dealer inquiries welcome*

## BBC MICRO REPAIRS by MICROFIX

ACORN AUTHORISED SERVICE CENTRE

**"Cumana Disc Drive and Acorn DFS  
supplied and fitted at low prices"**

We will repair your faulty BBC micro, disc drive or monitor quickly and at a reasonable charge. Most repairs cost between £10 and £20.

We can also offer extended warranties on all your equipment.

Send S.A.E. for full price list.

Phone 01-968 9214

or call in at

**191 Freston Road,  
(Latimer Road Tube)  
London W10**

and ask for

**Mark Duffill or Derek Mullings.**

## BBC/ELECTRON PROFESSIONAL SOFTWARE

*Our educational software is used in thousands of schools and homes throughout Great Britain.*

**KON-TIKI** by J Amos *BBC* *Tape £12.95 Disc £14.95*  
Simulation program based on Thor Heyerdahl's KON-TIKI expedition. Enjoy a journey on the Kon-Tiki recording on a map the raft's position and entering notes in the logbook on creatures found, unusual events etc. Inclusive of booklet, background information, maps and fully supportive illustrated data sheets.

**EDUCATIONAL 1** *BBC/ELECTRON* *Tape £8.00 Disc £10.00*  
Hours of fun and learning for children aged five to nine years. Animated graphics will encourage children to enjoy counting, maths, spelling, and telling the time. The tape includes six programs: MATH1, MATH2, CUBECOUNT, SHAPES, SPELL and CLOCK.  
*"... An excellent mixture of games" ... Personal Software - Autumn 1983.*

**EDUCATIONAL 2** *BBC/ELECTRON* *Tape £8.00 Disc £10.00*  
Although similar to Educational 1 this tape is more advanced and aimed at seven to 12 year olds. The tape includes MATH1, MATH2, AREA, MEMORY, CUBECOUNT and SPELL.

**FUN WITH NUMBERS** *BBC/ELECTRON* *Tape £8.00 Disc £10.00*  
These programs will teach and test basic counting, addition and subtraction to four to seven year olds. The tape includes COUNTING, ADDING and an arcade type game to exercise addition and subtraction. With sound and visual effects.

**FUN WITH WORDS** *BBC/ELECTRON* *Tape £8.00 Disc £10.00*  
Start your fun with alphabet puzzle, continue your play with VOWELS, learn the difference between THERE and THEIR, have games with SUFFIXES and reward yourself with a game of HANGMAN.  
*"... Very good indeed" ... A&B Computing - Jan/Feb 1984.*

**JIGSAW AND SLIDING PUZZLES** *BBC/ELECTRON* *Tape £7.95 Disc £9.95*  
There are two jigsaw and four sliding puzzles on a 3 x 3 and 4 x 4 grid. Each program starts off at an easy level to ensure initial success but gradually becomes harder. It helps children to develop spatial imagination and in solving problems. The tape includes: OBLONG, JIGSAW, HOUSE, NUMBERS, CLOWN and LETTERS!

### GAMES & UTILITIES

**GAMES OF LOGIC** *BBC* *Tape £4.95 Disc £6.95*  
For children and adults alike. The tape includes AUCTION, FLIP, REVERSE, TELEPATHY and HEXA 15.  
*"... This package is good value" ... Acorn User - Nov 1983.*

**SUPERLIFE** *BBC/ELECTRON* *Tape £4.95 Disc £6.95*  
Fast (machine code) version of a popular 'GAME OF LIFE' in a large universe.

**KATAKOMBS** *BBC* *Tape £5.95 Disc £7.95*  
The ultimate adventure game.

**UTILITIES** *BBC/ELECTRON* *Tape £5.95 Disc £7.95*  
An assortment of useful procedures and functions which can save you hours/days of programming effort: date conversion, input and validation routine, graphic routines, sort, search and many more.

★ SPECIAL OFFER ★

Buy three titles and deduct £4.00

Add 50p p&p per order. Please state BBC or Electron. Cheque/PO.

**Golem Ltd, Dept A, 77 Qualitas, Bracknell, Berks RG12 4QG. Tel: 0344 50720.**

# SERIOUS DECISIONS NEED THE SUPPORT OF OUR 80 COLUMNS



Most serious users of micro computers require the facility to display in 80 columns, especially for word processing. Try this on most monitors and the result will be a frustratingly fuzzy image.

The Microvitec CUB 653 gives the user not only glowing colour, but also pin-sharp-images, thanks to a medium resolution screen 653 pixels wide by 585 high, plus a selective transmission

panel giving super-high contrast. These features make this model from the CUB range of monitors the perfect partner for the high resolutions generated by BBC B, SINCLAIR Q.L., I.B.M.,

**MICROVITEC**  
**cub**  
COLOUR DISPLAYS

ELECTRON, ORIC, APPLE II and IIe, and many others.

So if you wish to sharpen your image, whether in the office or at home, decide Microvitec:

**Remember – the highest quality doesn't have to mean the highest cost.**

*Call at your local dealer or contact us direct and we'll send you full details with a pleasant surprise – our price list.*



# PRIVATE VIEW

Geoff Nairn turns the pages of the Edfax teletext emulator

108

'Edfax', Tecmedia, BBC model B with disk drive, £30 (£20 to schools)

**T**HE WORD teletext conjures up images of desperately looking under the sofa for the handset, or ploughing through interminable menu pages just to find out what's on television that evening. Add to this the delay between pages and the limited nature of the information stored on them, and the broadcast teletext services come out as very much the poor relation to public viewdata services such as Prestel. However, Prestel is expensive to use, and many organisations are now setting up their own private viewdata systems.

*Edfax* is a software package that lets you set up just such a system on a single BBC micro, with the pages of information stored on disc. Strictly speaking, it's a teletext emulator rather than a viewdata system; the difference is in the method of going from one page to another – more about this later. The name 'teletext', however, is reserved for broadcast services such as Oracle or Ceefax, so to avoid confusion *Edfax* will here be described as a private viewdata system.

The package was developed by Tecmedia in conjunction with the Microelectronics Education Programme primarily for the schools market, though it is available to others – albeit at a higher price. This means that the software has been tested at several schools before publication and that the manual accompanying the software covers educational objectives and possible applications, as well as being an easy-to-follow operating guide.

The software consists of two separate programs: the editor, which can create or edit pages of viewdata; and the display program, which, as its name suggests, is used to display the pages. The display program can be legally copied onto as many discs as you want, along with any pages.

Also on the disc is a database of 80 pages that demonstrates some of the

possibilities of the system. This is divided into three main sections, the first showing the use of the various viewdata 'attributes' – coloured text, double-height characters, etc – to create eye-catching pages. The second section demonstrates two possible applications of a viewdata system: a small database of possible career choices for children, and an 'electronic' school magazine. The third section is possibly the most interesting, containing 15 picture pages, all designed by schoolchildren and of a standard comparable to that of commercial 'information providers'.

The display program is simplicity itself to use: pressing SHIFT and BREAK automatically runs the program and displays page 100. In most teletext systems page 100 is reserved for the main menu, from which you select further sub-menus until you reach the desired page. The page numbers are keyed in as three-digit numbers that appear in the top left-hand corner of the screen, and after a couple of seconds the requested page appears on the screen. If the page number does not exist a message to that effect flashes up

and the program does not attempt to find the page on disc. A directory of valid pages must be held in memory.

Unlike proper viewdata systems, *Edfax* does not support page routing; to go from page 200 to page 201, for example, you have to key in the full page number '201'. With a viewdata system you might need to press only '1'. As some of the pages on Prestel can have up to 10-digit page numbers, page routing can save a lot of typing, but with only 80 pages on the *Edfax* system, the simpler teletext method of page access is quite adequate.

One of the best features of the display program is the 'cycle' facility, by which pages can be automatically displayed one after the other, in a similar fashion to a carousel slide projector. The delay between each page on the 'carousel' is preset at about 10 seconds, and to break the cycle you press the space-bar. This feature could be used for shop window displays, electronic noticeboards and other displays.

The 80 demonstration pages and the display program are good for familiarising yourself with how a viewdata



system operates, but the main aim of *Edfax* is to enable you to create your own pages and display them. The success or otherwise of any private viewdata system depends on how easily this can be done—that is, how easy the editor is to use.

The editor is a machine-code program and is copy protected. In a classroom, therefore, the program would have to be loaded into each computer in turn from the master disc—no backups can be made. On running the program you are asked to insert a data disc into the drive. This is the disc on which you want to save your pages, and a blank, formatted disc will be prepared to accept up to 80 pages (or 180 with an 80-track drive). As the Acorn DFS cannot support 80 different files, the editor at this point creates a single large datafile called PAGES, which is initially empty.

Next, a menu appears and you can



edit or create a page, display a page, display the directory of page numbers, or exit. On choosing the first option you are prompted for a page number: if it already exists the page will be loaded in for you to edit; if not, the screen goes blank and you are ready to create your first page.

At first sight the editor works much like any other on-screen editing system: you move the cursor around with the arrow keys and the typed text appears as white characters on a black background. When it comes to using the various viewdata attributes things get more complicated, however. These are selected using the BBC's red function keys; for example, to get the word 'HELLO' flashing in yellow letters, you press f2 (for yellow text), f8 (for flash on), and then type 'HELLO'. Other attributes change the background colour and select double-height characters, but they each occupy one 'invisible' character space in front of the text. This is an important point, because deleting the 'hidden' yellow text attribute in the example above will cause the text to revert to white.

To the novice these viewdata attributes can be a bit confusing, but the *Edfax* editor helps, to some extent, by



printing a message on the top line of the screen when the cursor is over one of these invisible attribute characters. Two final points: attributes apply only to text entered on the same line and only for text to the right of them.

Pages composed only of text are all right, but by adding graphics they can be made more interesting. Viewdata graphics are produced by first selecting a graphics colour—the 'shifted' function keys—and pressing any of the lower-case or numeric keys. Each key produces a graphics character based on a 3 x 2 pixel grid, but to find out what key gives which graphics character involves continually referring to the back of the *Edfax* manual. This can become very wearisome, especially if a lot of graphics are required.

As an alternative, it is possible to construct a graphics character from the individual pixels by selecting the 'Define Pixel' mode. If you look at a keyboard, the keys e, r, d, f, c and v form a 3 x 2 rectangle, and these are used to turn on or off the six pixels making up the graphics character. This method is useful if you are not sure which graphics character would best suit a particular part of a picture, but it would be too laborious to make up all the graphics characters in this way.

The *Edfax* editor could do with some



extra features: there is no method of inserting characters, for example—very frustrating if you have just done a page heading and then find it's not quite centred. Similarly, there are no facilities for moving or copying blocks of characters, or for inserting or deleting lines. These omissions are a result of *Edfax's* having been designed primarily for schools, where ease of use

counts for more than sophistication, and Tecmedia is apparently working on a Mark 2 version with more advanced editing facilities, as well as a suitable screen dump routine for printers.

Having created your page you can save it on disc, either with the same



number as that used to load it—and thereby deleting the old page—or with a different page number. You are also asked for a 'cycle page number'—the number of the page you want to follow yours in the 'carousel'. If you don't want the page to cycle you supply the number '000'.

The possible applications for *Edfax* are limited only by the imagination of the user. In schools, a group of children could produce an 'electronic newspaper', or a specialised database could be created for a history project; a high street shop could install a BBC in its front window and advertise the week's special offers.

To summarise, *Edfax* serves as a



relatively cheap and simple introduction to the world of viewdata systems. The display program and sample database of pages nicely demonstrate the concept without the expense of teletext adaptors or modems. The editor is not particularly sophisticated, and the graphics are tedious to use, though this is a problem inherent in any viewdata editing system.

Previously, the software to set up a private viewdata system has cost several hundred pounds and required dedicated terminals. *Edfax*, at just £30 and running on a BBC micro, changes all that and will further encourage the growth of viewdata systems.

# MUG SHOTS..

## for £174 plus VAT.

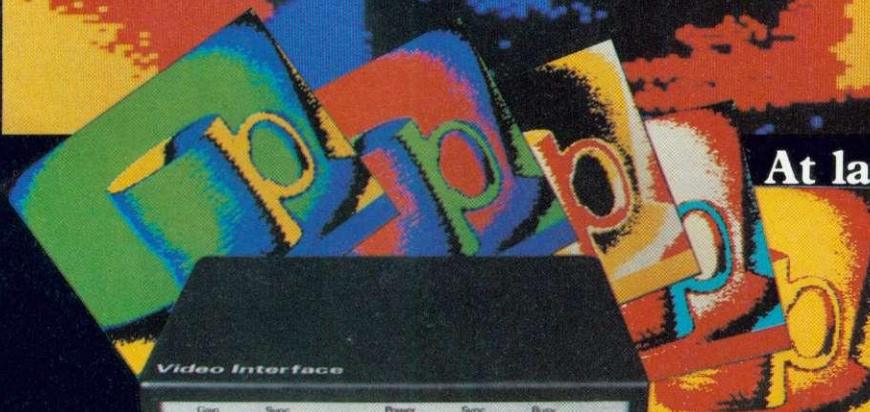
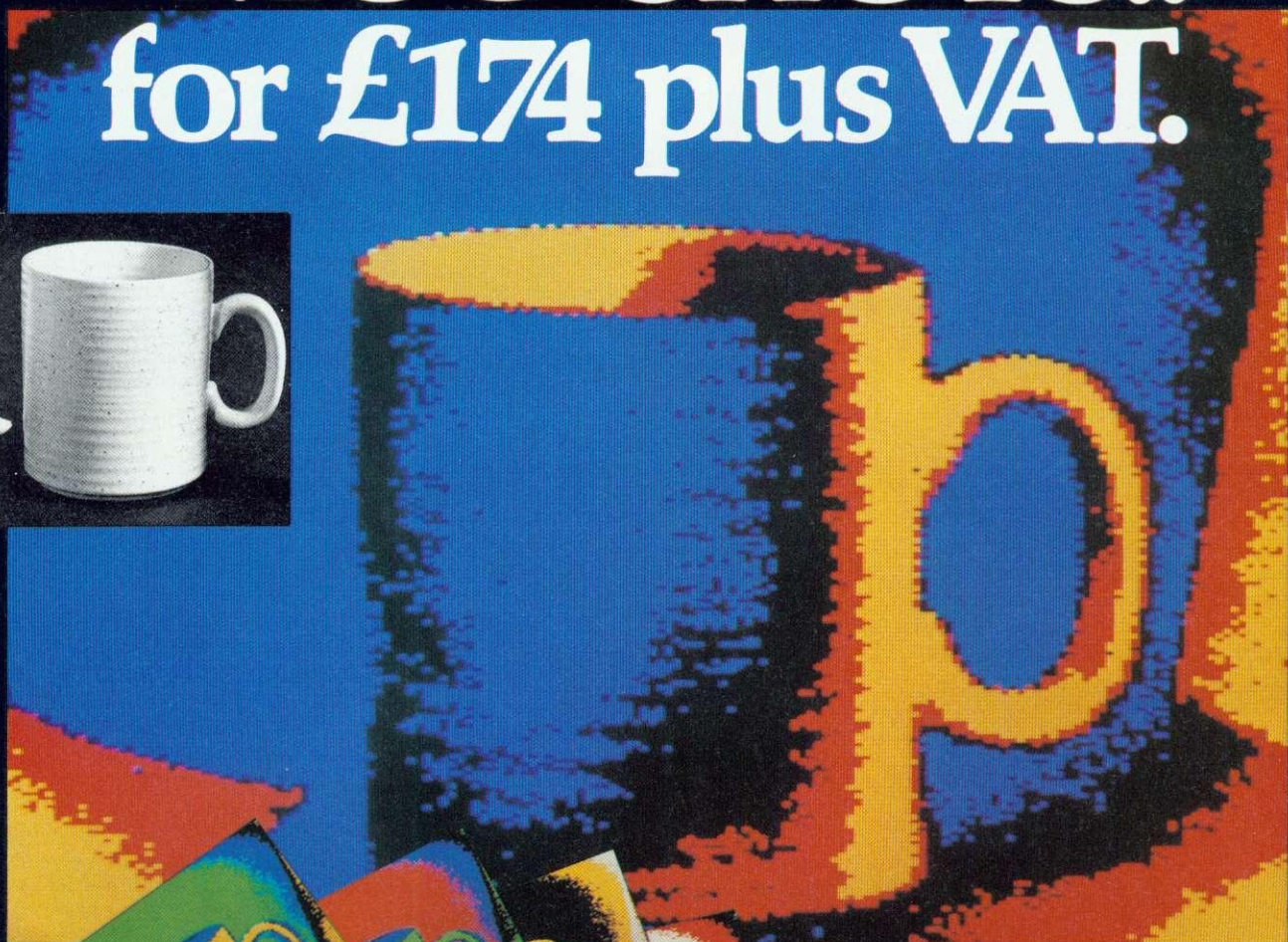
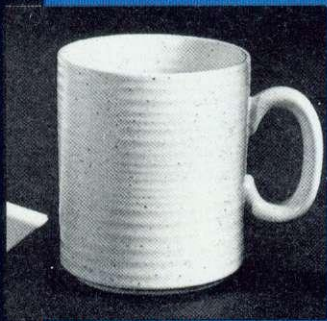

At last. A sensible, low-cost video camera interface to use with your BBC microcomputer.

Now available to the micro-user, here is an interface to permit unlimited manipulation of digitised images from a video camera. Imaginative operators will be quick to realise the potential of the unit and space permits us to list only a few applications, viz: Computer aided graphics and design—image analysis for the physical sciences and education—robot vision—security—automatic map and photograph analysis—visual perception experiments, etc.

Taking a typical application, an ordinary video camera (black/white or colour) is focused on the subject. A single keystroke command causes the Video Camera Interface to digitise the image and display it on the micro-computer's monitor. Extensive menu-driven software options allow changes of colour palette, the ability to store (and retrieve) images from disc and screen dumps to EPSON printers.

The V.C.I. is under user control as the well documented software permits considerable flexibility in the way an image is scanned and stored. Full technical details are given in the 27 page user guide.

For quantitative image analysis the V.C.I. has a resolution of 220 (horizontal) and 312 (vertical) pixels and resolves 64 grey levels.

**A complete package:**

The V.C.I. comes complete with extensive software and user guide, connecting cable to the BBC user port and its own power supply.

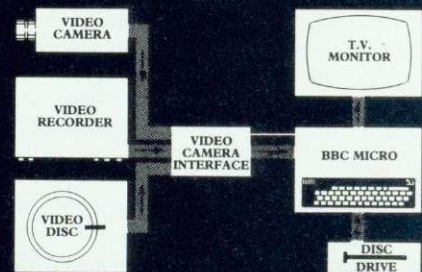

The Data Harvest Video Camera Interface package is available now and can be obtained direct from us, enclosing your remittance of £202.90 (includes PP and I and VAT). Overseas users should make payments by I.M.O.

**DATA**  
harvest

Specialists in cost effective data capture.

28 Lake Street, Leighton Buzzard, Beds. LU7 8RX

Tel: Leighton Buzzard (0525) 373666

Free. Technical brochures available by sending large S.A.E.



# TEACHING INFORMATION THE SOFT WAY

Packages are becoming available that can turn the classroom into a microcosm of the wider world of information exchange. Jean Beck sorts them out

111

**I**N THE world at large, information handling, communications and storage have become immensely sophisticated involving automation and advanced electronic engineering. Moreover, the new approach to information is widespread, affecting many corners of our everyday lives. Communications advances now make it possible to patronise famous Oxford Street stores without leaving your home. Goods can be ordered 'electronically', entering the appropriate credit card number and awaiting delivery of the goods. With the right program and a modem link through the telephone system, this is possible with most home computers.

Customers in banks use information technology to withdraw cash and order statements and cheque books. The travel agent avails himself of it to check hotel reservations, book flights and transfer payments. The Nottingham Building Society has won new customers by offering investors who maintain a minimum sum in their accounts with the necessary technology in their homes to conduct all their transactions electronically.

But information technology has potential outside directly commercial transactions, too. The public library, for example, is now equipped to provide a variety of information sources. As well as traditional reference such as encyclopedias, trade directories, indexes, a terminal may be available to access an on-line database, such as Prestel, which is being constantly updated.

Despite the infusion of communications technology within society, information handling and communication in schools is still largely limited to reading, writing and talking, while information storage is confined to hand-

written notes and printed books. Information and communication have always been a substantial part of teaching and learning, with implications right across the curriculum.

The technological revolution cannot therefore be ignored by educationalists. A recent survey estimated that more than one in ten homes in the UK now have a microcomputer, and this figure is growing.

But integrating the new technology into schools presents problems, not least because of the speed with which it has arrived. Older teachers are often unwilling to come to grips with the

unfamiliar technology of what the Department of Industry defines as 'The acquisition, processing, storage and dissemination of vocal, pictorial, textual and numerical information by a microelectronics based combination of computing and telecommunications'. And even teachers graduating in the 1980s may know nothing about this technology.

All this points to the need for a broad training programme, producing not only teachers in the specialist subjects of information technology and computer studies but bringing all teachers up to date with the relevance of infor-

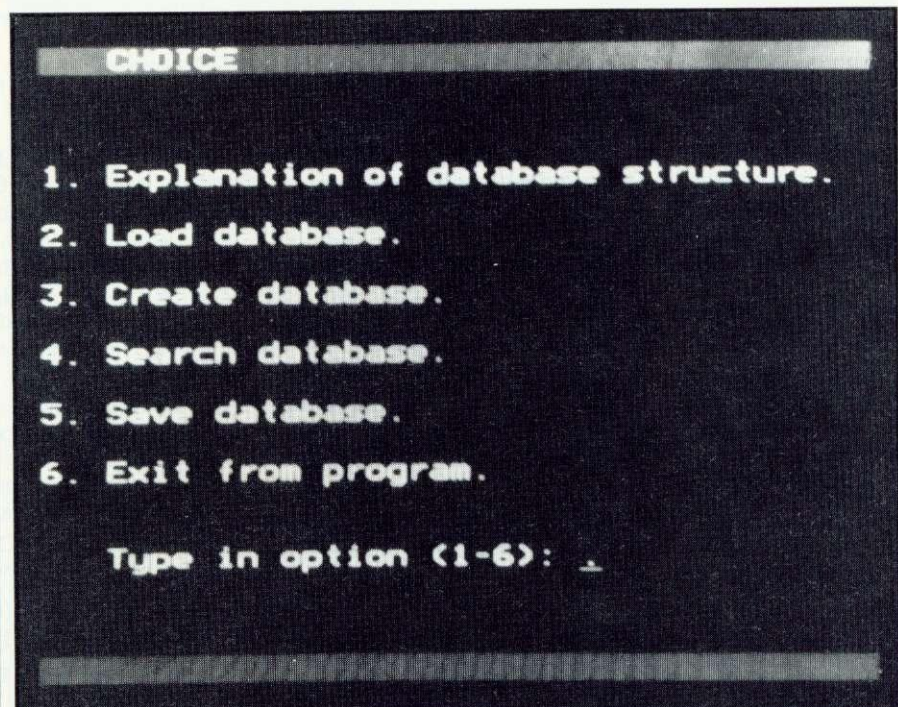

Sample from an initial database menu

## SPELLWISE

Is yore speling  
reely atroshus?

Or is it just a littel bit off kei?

In either case you need  
**SPELLWISE.**

### SPELLWISE

- is a spelling checker for use with your BBC micro and WORDWISE word processor
- is a DISC or tape based machine code program with comprehensive user manual
- contains an expandable dictionary of over 6000 words (3000 on tape)
- will check a maximum size WORDWISE document
- checks the Wordwise example document in under 11 minutes
- performs a case dependent check, detecting errors such as 'london'.

SPELLWISE diligently checks every word in your text against the SPELLWISE data file. When it has finished you will be left with a list of words which are incorrectly spelt or typed, or are not in the base vocabulary of more than 6000 words (3000 in the tape version). Software is included to enable you to create your own data files. The tape version requires a recorder with motor control.

**TAPE SPELLWISE £12.**  
**DISC SPELLWISE £18**

Backup copy £4 extra if ordered at the same time as your disc, or £8 if ordered subsequently. Please state 40 or 80 track.



**FLOPPYCAT: DATAWARE CATALOGUE ON A REUSABLE 40 TRACK SINGLE DENSITY 5 1/4 INCH DISC WITH A 5 YEAR MANUFACTURER'S GUARANTEE. 2 GUINEAS (£2.10)**

## LANGUAGEWISE

LANGUAGEWISE will allow you to prepare text on WORDWISE in any of the following languages:-

Albanian, Brazilian, Catalan, Czech, Danish, Dutch, Estonian, Finnish, Flemish, French, Friesian, German, Irish, Italian, Lozi, Norwegian, Polish, Portuguese, Rumanian, Sardinian, Scottish-Gaelic, Serbo-Croatian, Slovakian, Spanish, Swedish, Turkish, Walloon, Welsh, Yugoslavian.

LANGUAGEWISE will print on an Epson FX80 printer and preview your text with ALL the necessary accented characters included.

*Où est le café? le grève, la fête, à la hâte, la gîte, le rôle, en août, le garçon, Noël, naïve, une œuvre, Edipe.*

LANGUAGEWISE on DISC only with machine readable manual ready for printing £18

### DATAWARE

**FREEPOST SWINDON SN3 4BR**

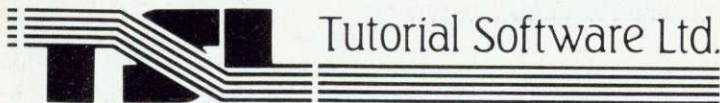

Tutorial Software Ltd.

## SENIOR SCHOOL EDUCATIONAL PROGRAMS

Developed in schools and now available to interested home micro users. Research has identified the compulsory exam topics, and professional programmers have coded these into exciting educational games which have been proven to effectively teach and entertain.

Now available for BBC B and ELECTRON. Each pack contains main program, extra self test program and Core Facts book for only £11.95 or any two for £19.95.

**MATHS 1:  
TRY-ANGLES**

Draughts style teaches angles ratios, tan, sin, cos. 25 levels

**MATHS 2:  
COORDINATES**

Battleship style teaches x and y in four sectors, directed numbers

**PHYSICS 1:  
ARCHIMEDES**

Submarine style teaches Archimedes Principle, pressure and upthrust

**PHYSICS 2:  
ISAAC**

Gunnery style teaches mass, weight Newtons Laws and projectiles

**GEOGRAPHY 1:  
MAYDAY**

Orienteering style teaches O.S. symbols, grid references, bearings

**GEOGRAPHY 2:  
WEATHER**

Forecasting style teaches symbols, pressure systems, synoptic charts

Send your name, address, and cheque/P.O. to DEPT. A.  
TUTORIAL SOFTWARE LTD., FREEPOST, WIRRAL, MERSEYSIDE L61 1AB.  
Please state BBC B or ELECTRON

## GUARDIAN SOFTWARE

presents

for DISK OWNERS

## SOURCE LIBRARY MANAGER (SLM)

A new concept in ROM based software for the BBC MICRO

Features include:

- ★ Stores and retrieves any amount of BASIC and/or ASSEMBLER source code, upto the full capacity of a disk (100/200k).
- ★ Creates a LIBRARY of upto 399 "members" per 80 track disk or upto 199 "members" per 40 track disk.
- ★ Allows upto 99 versions of a single program or routine.
- ★ Will simply and easily "construct" programs developed in a modular fashion.
- ★ Stores fully documented code which can be "stripped" when required for execution.
- ★ Uses 8 char names and a 20 char description for each "member".
- ★ Is fully menu-driven (i.e. no messy commands).
- ★ Includes 15 page Manual (A4 size) and fitting instructions.
- ★ Many other features too numerous to list here.

FULLY COMPATIBLE WITH 6502 SECOND PROCESSOR

IDEAL FOR BEGINNERS AND  
EXPERIENCED PROGRAMMERS ALIKE

PRICE £36 (incl. p&p) or large SAE for Fact Sheet to:

**GUARDIAN SOFTWARE**  
21 Harvey Road, Walton-on-Thames  
Surrey KT12 2PZ

mation technology to what they are teaching.

Pupils have always needed to be able to handle information and to communicate, and a good secondary education lays the foundation for independent information handling and retrieval by showing them how to use written reference sources. Even at this comparatively straightforward level, however, many pupils use these unselectively or inappropriately when completing project work.

Students now need to be aware of the new technology, its potential and limitations, and they need to develop the right kind of skills to survive in a society whose transactions are conducted through information technology. There are vast resources of information from outside sources to which the micro-computer in the classroom, serving as a terminal, can have direct access – and many schools have set up their own databases. The development of information technology skills therefore becomes a matter of urgency.

These skills need to be reinforced and developed across the curriculum and throughout the child's school life, and this can happen only as a result of a coherent education policy. Careful thought must be given about how micros can contribute to both the traditional and the new aims of education. The following aspects of information technology should be highlighted:

- **Accessing** information – Sources can only be accessed if one knows it exists, has an idea of the sort of information available and knows the searching strategy required for that source.
- **Evaluating** information – Children must be given criteria by which they can evaluate information. There is a great tendency to accept as gospel information on the screen, and pupils need to be aware that what is read on a screen has been put there by an information provider.
- **Manipulating** information – Technology allows us to manipulate facts in a way that has never been possible before. Pupils need to be shown the potential in this area.
- **Distributing** information – Electronic methods of communications such as electronic mail are changing the ways in which information is distributed.

Thanks to the Department of Trade and Industry's scheme to put a micro in every secondary and primary school – an ambition now virtually achieved – there is enough technology in schools to get started, plus the programs that allow us to introduce schoolchildren to the concepts of information storage, retrieval and manipulation. The BBC

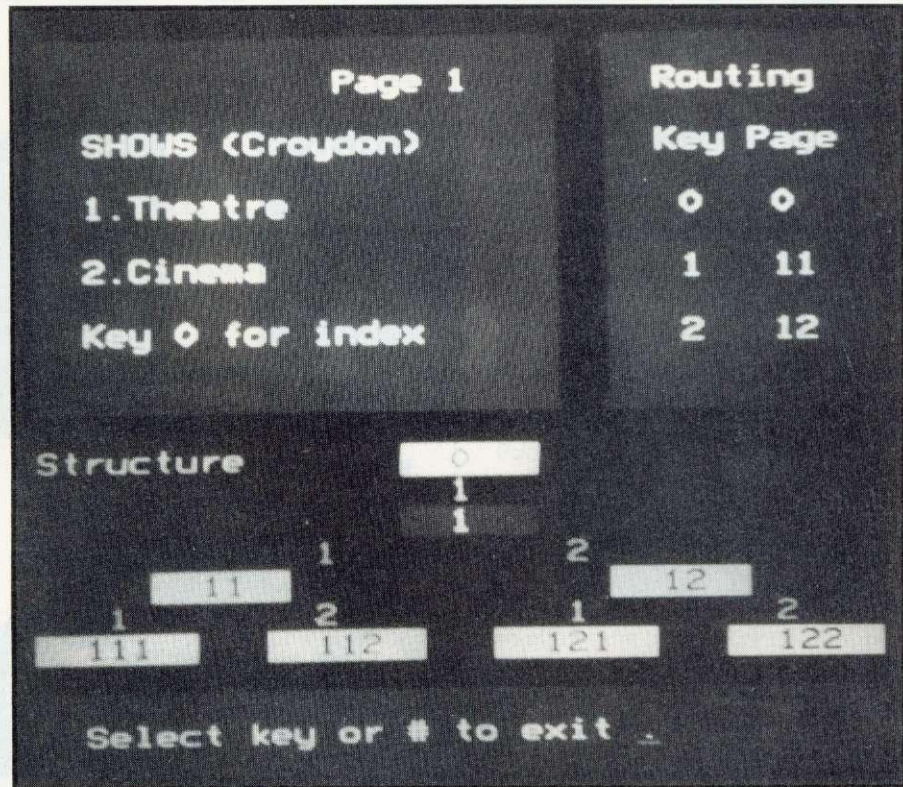

Tree structure of a database showing diagrammatic routing

micro is particularly well-equipped in this respect, with software that satisfies the aims of using microcomputers in education as enumerated by Daniel Chandler in the teacher's handbook for Factfile, a suite of programs provided as part of the Microelectronics Edu-

cation Programme. Chandler's priorities were:

- To introduce the computer as a versatile, subject-independent learning aid.
- To provide a teaching tool that will be of use in stimulating discussion,

## SOFTWARE SOURCES

The MEP *Microprimer* pack is available from Tecmedia, 5 Grandby Street, Loughborough LE11 3DU (tel: 0509 230248) at £107.49 (£49.93 for schools) until July 1, when the price rises to £118.28 (£55).

*Factfile* pack from the Cambridge Micro Software division of Cambridge University Press (tel: Cambridge 64122). Price: £15 plus VAT. This was reviewed in the March issue.

*Quest*, an information handling package, is obtainable from the Advisory Unit for Computer Based Education, Endymion Road, Hatfield (tel: Hatfield 65443). The tape version costs £15 and the disc £17 (including p&p).

*Dataprobe* A double pack under preparation at Addison Wesley, Finchampstead Road, Wokingham, Berkshire RG11 2NZ (tel: 0734 794000) aimed at the 10-12 age group. Price yet to be decided. Probably available in late autumn.

*Edword* (16k ROM) from Clwyd Technics, Unit 4, Antelope Industrial Estate, Rhydymwyn, Clwyd CH7 5JH. The Teacher Pack costs £18.95 (£21.95 disc); User Pack £38.95 and Starter Pack £56.95 (£59.95) – all excluding VAT.

*Wordwise* (8k ROM) from Computer Concepts, 16 Wayside, Chipperfield, Herts WD4 9JJ (tel: 09277 69727). Price: £46 (incl VAT and p&p).

*Prestel emulator* from the Independent Schools Microelectronic Programme (ISMEC), Westminster College, Oxford OX2 9AT (tel: Oxford 725904). Price: £19.95 for disc and manual.

The Nottingdale ITEC *local viewdata package* is being prepared by the ITEC Consultancy and will be available through Acornsoft in September.

*Edfax* is available from Tecmedia at £34.68 (see review on page 108 of this issue).

# For little Acorns Mighty SHARDS Grow

# SHARDS

software

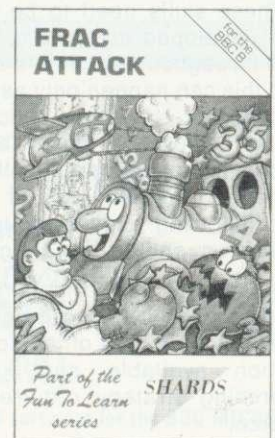
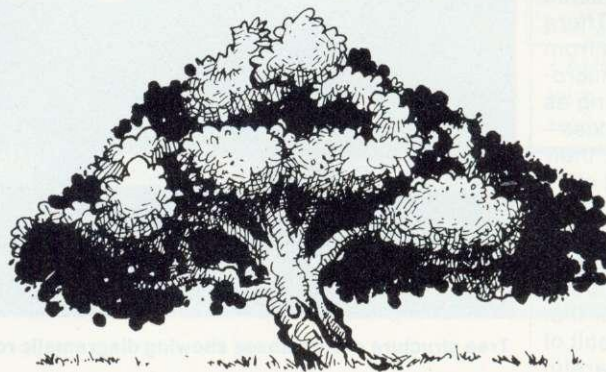
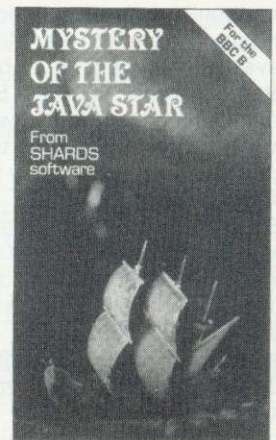
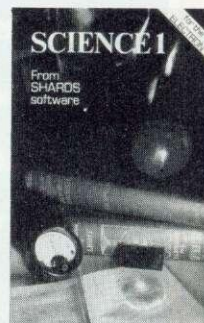
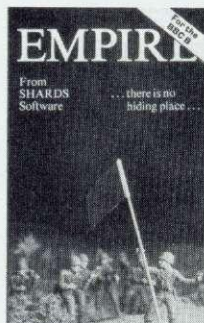
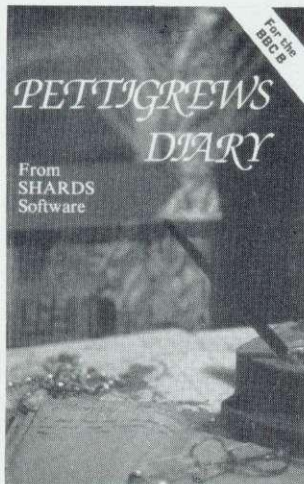

If you want well written and presented software for your Acorn computer then take a look at Shards. Shards can offer you entertainment and educational software that really is a cut above the rest.

Take a look at Shards.

### Adventure and Strategy Games

**Pettigrews Diary £7.95**

A massive 90K graphic/text adventure with a difference. Can you solve it?

**Empire £6.95**

A superb graphic strategy game against the computer. 8 levels of difficulty. Played on a world map. Win at level 7 or 8 and you deserve a pat on the back!

**Mystery of the Java Star £7.95**

A graphic adventure for all the family. Utilises 100K of memory. Gripping stuff!

### Educational

Fun to Learn, the definitive educational series – written by teachers and used in schools nationwide. All programs are menu based and make superb use of graphics. 100% user friendly and error trapped.

"This is how educational software should be written..."

**Fun to Learn £6.95**

A comprehensive program for 6-12 year olds.

**Monster Maths £6.95**

Helps develop basic maths and logical skills for 6-14 year olds.

**Laser Letters £6.95**

Educational word games for 6 year olds to teenagers. Three separate 500 word vocabularies.

**Frac Attack £6.95**

Fun with fractions for 8-14 year olds.

**Science 1 £6.95**

Science education for 11-16 year olds. Covers the use of lenses, meters, thermometers and balances. Super graphics.

Selected titles available at larger branches of Boots and W. H. Smith and all good stockists or by sending a cheque/P.O. direct to us at: Suite G, Roycraft House, Linton Road, Barking, Essex. Tel: 01-591 7666 (4 lines)

(BBC & Electron)

(BBC & Electron)

(BBC & Electron)

Home Computing Weekly

(BBC)

(BBC)

(BBC)

(BBC)

(BBC & Electron)

Please send me a copy of:- (please tick)

Pettigrews Diary  Fun to Learn

Empire  Monster Maths

Mystery of Java Star  Laser Letters

Science 1  Frac Attack

Please indicate which version required:-

BBC B  Acorn Electron

To (Name) .....

(Address) .....

Please debit my Access/Visa account.

A/C No. ....

I enclose a cheque/P.O. remittance for £ .....

(Signed) .....

All cheques/P.O. to be made payable to  
**Shards Software**

\* All orders despatched within 24 hours of receipt.

encouraging creative writing and in preparing project work.

- To encourage the skills of ordered thinking and organising information.
- To enable children to assess the results produced by a computer and to be aware of the limitations of these techniques.

The following programs provide information handling and communication on the BBC micro:

- Factfile, Quest or Dataprobe to store and manipulate information.
- Edword or Wordwise to enable word processing.
- The ISMEC or Nottingdale ITEC packages, which allow the BBC micro to be linked to another computer and serve as a terminal for electronic mail or to access vast databases stored on remote mainframe computers, or to link schools in an area together on a local viewdata system.
- Edfax to simulate a teletext system.

In conjunction with the Dol, the Micro-electronic Education Programme sponsored a two-year project in Croydon to develop an IT curriculum for the 9-14 age range. The Croydon project aims to ensure that the educational needs spelt out by Daniel Chandler are met by producing pupil material, including software, for years 1 to 3 of the secondary

word processing allows anyone to produce almost perfect work. Less able pupils can build up a folder of neatly printed, corrected, work much more quickly than previously.

The booklet on information skills has a value beyond the scope of an IT course and can be used in any situation where project work is being used.

The series also deals with databases as applied in many situations in school, for example in history with census

## ‘Information may be retrieved very quickly to answer a question’

materials; in science with databases on energy, pollution, periodic tables; in careers information; fiction and literature databases in English; and weather statistics in geography. They also, of course, serve as information providers in general through electronic school magazines. The *Serial* program demonstrates a simple database which stores data in simple tabular form. It

### POINTS TO REMEMBER

1. Information skills are as much basic skills as literacy and numeracy.
2. Schools cannot opt out of the information technology revolution – it is here to stay.
3. Schools should plan ambitious courses even though their current equipment is inadequate.
4. Information technology teaching should use the technology to produce confident and competent flexible thinkers and independent learners.
5. Pupils must develop a critical awareness of the value of information provided by various sources.
6. There is no need to invent uses for information technology when so many are seen in everyday life.
7. IT opens new possibilities for pupils of all abilities, and teachers must not be frightened to allow the pupils to develop independently.
8. Teachers can find learning with their pupils, rather than always teaching them, a rewarding experience.
9. The full benefits of an IT curriculum will be obtained only in a school which has a comprehensive and coherent policy.

## ‘Teachers prepared to learn with children find it rewarding’

school. The first fruits of the project, six booklets with accompanying software and teacher's guide, are being published in September by Addison Wesley, followed by a second set in April 1985.

The first booklets deal with information handling, information skills, and information retrieval. The materials and the programs have been designed to introduce pupils to the basic concepts, develop an awareness of the potential and limitations of technology, and develop the skills to exploit more fully the programs mentioned above. The entire course can be followed, or specific sections considered relevant at the time may be selected.

Two of these booklets provide a framework within which each pupil can develop into an independent and flexible information handler. Experience shows that the technology can unlock previously unseen potential in some slower learning students. For example,

allows serial access to a small number of records which can all be displayed on the screen simultaneously: *Link* demonstrates how pointers can speed searching the file; and *Invert* shows the use of inverted files as used in keyword databases.

With *Invert*, all the database can be seen on the screen but this still allows sufficient data to show how the price paid for inverting the file is offset by the immense increase in speed of access. It is hoped that pupils will move from this simple demonstration to using the British Library SIR program when it becomes available on the BBC.

Pupils should gain experience of viewdata systems, whether through local networks or British Telecom. The *Tree* program starts with a simple tutorial on hierarchical data structures, with the VDU used as an overhead projector. The main part of the program then allows the user to create a simple Prestel-type database including all routing between the pages.

Information technology gives the teacher another tool in helping pupils to manipulate information in a way that was not possible before. For example, information may be retrieved very quickly to answer a particular question and then displayed visually using programs which create maps or scattergrams.

Some teachers will feel that they have not had enough training or time to come to terms with the technology themselves, and so may be hesitant

## ‘Pupils should gain experience of viewdata systems’

about using it with a class of pupils. However, the basic concepts of information and communication remain the same. Experience has shown that teachers who are prepared to learn with the children find it a very rewarding experience.

Teachers have a professional responsibility to ensure that they educate children for today's world. These materials aim to provide a basis from which to start, introducing pupils to the concepts of IT, rather than to specific equipment and programs, to help them make IT work for them.

*Jean Beck is the Communications and Information Studies Co-ordinator for Capital Region of MEP and is based at Kingston Polytechnic. Paul McGee is consultant to this series.*

## DOT MATRIX PRINTERS



ALL PRINTERS HAVE CENTRONIC PARALLEL INTERFACE UNLESS OTHERWISE STATED. ALL PRINTERS HAVE HI-RES. DOT ADDRESSABLE AND GRAPHIC MODE. PLEASE SEND SAE FOR FULL DETAILS.

<b>EPSON</b> FX 80 160 CPS, 10" wide fric. & pin feed	£344 + VAT	£395
FX 100 160 CPS, 15" wide fric. & tract feed	£431 + VAT	£495
RX80 FT 100 CPS, 10" wide fric. & tract feed	£261 + VAT	£299
RX80T 100 CPS, 10" wide tractor feed	£234 + VAT	£269
LQ1500 200 CPS Letter quality printer		
8143 RS 23 Interface for FX and RX printers.	£29 + VAT	£33
8148 RS232 Interface with 2K buffer, son.xoft	£50 + VAT	£59
Ribbon Cartridge for FX80 FX80 & MX80	£7 + VAT	£7
Ribbon Cartridge for FX100 & MX100	£12 + VAT	£13
<b>STAR</b> Gemini 10X 120 CPS, 10" wide fric. & tract feed	£200 + VAT	£229
Gemini 15X 120 CPS, 15" wide fric. & tract	£295 + VAT	£339
Delta 10 160 CPS, 10" wide fric. & tract feed	£327 + VAT	£375
Delta 15 160 CPS, 15" wide fric. & tract feed	£414 + VAT	£475
Radix-10 200 CPS, NLO, 10" wide tractor feed		
Radix-10 200 CPS, NLO, 16K Buffer Par & serial interface, downloadable characters, incredible value at	£431 + VAT	£495
Radix-15 15" wide version of Radix-10	£518 + VAT	£595
<b>SEIKOSHA</b> GP100A 50 CPS, 10" wide tractor feed	£156 + VAT	£179
GP250X 50 CPS, 10" wide tractor feed, ser. & par.	£196 + VAT	£225
GP100YC 300 CPS, 10" wide, VIC 20 & 64 inter.	£174 + VAT	£199
GP500A 50 CPS, 10" wide tractor feed	£187 + VAT	£215
GP550A 50 CPS, 10" wide tractor feed & tract correspondence quality		
GP100AS. Serial interface, ideal for Spectrum with microdrive	£234 + VAT	£269
	£174 + VAT	£199
<b>SHINWA</b> CP80 80 CPS, 10" wide tractor & tract feed	£187 + VAT	£215
Spare ribbon cartridge for CP80	£6 + VAT	£6
<b>RITEMAN</b> Compact 120 CPS, 80 col. fric. & tract feed	£200 + VAT	£229
<b>CANON</b> PW1080A 160 CPS, 10" wide, 27 CPS NLO 24 x 16 matrix	£283 + VAT	£325
PW1156A 160 CPS, 15" wide, 27 CPS NLO 24 x 16 matrix	£347 + VAT	£399
<b>COLOUR PRINTERS</b> Seikosha GP1000 7 colour, 50 CPS printer	£347 + VAT	£399
Canon PJ1080A 7 colour, 40 CPS ink jet printer	£391 + VAT	£449
CP940 40 column 4 colour battery operated	£118 + VAT	£135

ALL OUR PRINTERS HAVE 1 YEAR WARRANTY

## DAISYWHEEL PRINTERS



<b>JUKI 6100</b> 20 CPS Bi-Directional Logic, seeking 10, 12, 15 CP1 + PS Spacing, 2K buffer, bes. selling Daisywheel Singer sheet feeder unit Tractor Unit RS 232 Interface Spare Daisywheel	£349 + VAT £217 + VAT £95 + VAT £52 + VAT £17 + VAT	£395 £249 £109 £59 £19
<b>BROTHER HR-15</b> 13 CPS, Bi-directional, 10, 12, 15 CP1 + PS Keyboard Unit Single Sheet Feeder Unit Tractor Unit	£344 + VAT £139 + VAT £217 + VAT £95 + VAT	£395 £159 £249 £109
<b>DAISY STEP 2000</b> 20 CPS Unidirectional, 10, 12, 15 CP1	£260 + VAT	£299
<b>SMITH CORONA TP1</b> 12 CPS, 10, 12, CP1 unidirectional	£208 + VAT	£239

## PROFESSIONAL MONITORS

\* SANYO  
\* MICROVITEC  
\* FIDELITY  
\* PHOENIX



<b>SANYO</b> DM8112 12" Green screen 18 MHz Hi-Res	£86 + VAT	£99
DM2112 12" Green screen 15 MHz Monitor	£86 + VAT	£75
CD3125 14" RGB Normal Res. Colour Monitor	£173 + VAT	£199
CD3117 14" RGB Medium Res. Colour Monitor	£286 + VAT	£329
CD3115 14" RGB High Res. Colour Monitor	£331 + VAT	£449
<b>MICROVITEC CUB</b> 1431 MS 14" RGB Normal Res. Colour Monitor	£173 + VAT	£199
1451 MS 14" RGB Medium Res. Colour Monitor	£323 + VAT	£369
1441 MS 14" RGB High Res. Colour Monitor	£417 + VAT	£479
<b>FIDELITY</b> Colour Monitor CM14 14" RGB, RGBY Composite sound col	£187 + VAT	£215
<b>PHOENIX</b> Phoenix High Res. 12" Green Monitor	£66 + VAT	£75
Phoenix High Res. 12" Amber Monitor	£69 + VAT	£79

AKHTER INSTRUMENTS LTD T/A



## COMPUTER GROUP

28/29 BURNT MILL  
HARLOW, ESSEX. CM20 2HU U.K.  
Tel. HARLOW (0279) 443521 Telex: B18894 AKHTER G

## BBC MICROCOMPUTER SYSTEM

WE ARE AN OFFICIAL BBC COMPUTER DISTRIBUTOR

DEALER ENQUIRIES ARE WELCOMED

**Acorn Electron £199<sup>INC</sup> VAT**  
WE SUPPLY FREE 30 HOUR BASIC BOOK AND A DUST COVER WITH EACH BBC COMPUTER

BBC is the best microcomputer currently on the market. 32K RAM, 32K ROM, 8 modes of operation, full colour, full-size keyboard, internal expansions such as disc interface, speech synthesizer, Econet interface - In short it is a personal computer capable of expanding into a small business system.

BBC Microcomputer Model B	£348 + VAT	£399
BBC Mod B - disk interface	£409 + VAT	£469
BBC Mod B - Econet interface	£389 + VAT	£447
BBC Mod B - disk and Econet interfaces	£450 + VAT	£517
BBC 100K disk drive	£230 + VAT	£264
BBC dual 800K disk drive	£699 + VAT	£803
Torch Z80 disk pack including Z80 2nd processor, 64K RAM and CP/M operating system - Free Perfect Software	£696 + VAT	£799
BBC Teletext receiver (Aug)	£196 + VAT	£225
BBC cassette recorder and lead	£26 + VAT	£29
Disk interface kit (free fitting)	£84 + VAT	£86
Mod A to Mod B upgrade kit	£70 + VAT	£80
Fitting charge for A to B upgrade kit	£20 + VAT	£23
16K memory upgrade kit	£30 + VAT	£34
Games paddles	£11 + VAT	£12
12" Monochrome monitor incl. cable	£99 + VAT	£103
14" Colour monitor incl. cable	£199 + VAT	£222
User guide	£10 + VAT	£10
Econet interface (free fitting)	£80 + VAT	£69
Speech interface (free fitting)	£47 + VAT	£54
BBC disk manual - formatting disk	£30 + VAT	£34
Parallel printer cable	£10 + VAT	£11
BBC word processor (view)	£52 + VAT	£59
BBC Fourth language cassette.	£15 + VAT	£17
BBC Lisp language cassette	£15 + VAT	£17

### APPROVED ECONET SERVICE CENTRE

WE STOCK A LARGE RANGE OF SOFTWARE FOR BBC MICRO INCLUDING ACORN SOFTWARE, LOGIC SOFTWARE, LONGMANS SOFTWARE. PLEASE SEND LARGE STAMPED ADDRESSED ENVELOPE FOR FULL DETAILS.

## TORCH Z80 2nd PROCESSOR

For only £347 + VAT

Torch 2nd Processor Z80 is supplied with perfect writer (a powerful Word Processor), perfect speller (spelling checker program - I should have used one for making this advert!), Perfect Filer (A Database Program), Perfect Calc (Spread Sheet). It includes 64K memory (Almost 60K available to user). Fits inside BBC Computer.

Z80 2nd Process - Perfect Software	£347 + VAT	£399
Z80 Processor - Perfect Software - Dual 800K	£329 + VAT	£379
Disk Drives	£695 + VAT	£699

## GUARANTEED LOWEST PRICES

### 100% BBC COMPATIBLE MITSUBISHI AND TEAC SLIMLINE DISK DRIVES



These drives are supplied ready cased with all the necessary cables, formatting program and User Guide.  
There are some very useful utilities included on formatting disc e.g.  
- DISASSEMBLER. This is 6502 machine code disassembler.  
- DUP. To copy and rename a file on disc.  
- FORMAT. Formatting program for 40 & 80 tracks.  
- FREE. This utility provides a disk usage analysis.  
- MDUMP. Enables you to display and modify any part of BBC memory.  
- MERGE. Merge a number of text files into one file.  
- RELOCATE. Downloads a basic program to &800.  
- SDUMP. Screen dump for EPSON in all graphic modes.  
- VERIFY. Verifies every sector on a disk.  
- MENU. A flexible menu program.

Single drive 100K 40 trks, single sided	£147 + VAT	£169
Dual drive 200K 40 trks, single sided	£284 + VAT	£329
Single drive 200K 40 trks, double sided	£173 + VAT	£199
Dual drive 400K 40 trks, double sided	£330 + VAT	£379
Single drive 400K 80 trks, double sided	£199 + VAT	£229
Single drive 400K 40/80 trks, switchable, DS	£217 + VAT	£249
Dual drive 800K 80 trks, double sided	£382 + VAT	£439
Dual drive 800K 40/80 trks, switchable, DS	£408 + VAT	£469

All above drives are low power slimline (0.3 A typ at +12v and 0.4 A at +5v per drive). Normally extra power supply is not required; the BBC Computer power supply is designed to drive two low power drive (IT IS NOT DESIGNED TO DRIVE INTERNAL ROM BOARD).

40 Track SS/DD diskettes (10/Box) £18 + VAT = £20  
40 Track DS/DD diskettes (10/Box) £23 + VAT = £26  
80 Track SS/DD diskettes (10/Box) £28 + VAT = £32  
80 Track DS/DD diskettes (10/Box) £33 + VAT = £34

ALL ABOVE DISKETT ARE CERTIFIED EITHER MEMOREX OR DETALIFE

## YOUR CONTACTS AT AKHTER ARE

DEALER/BULK ENQUIRIES	HAMAYUN MUGHAL
TELEPHONE ORDERS	PAULA HAYES
DEALER ORDERS	TONY GLOVER
BUSINESS SYSTEMS ENQUIRIES	DENNIS SUTCH
EXPORT ENQUIRIES	MAHAMAD EDIB
ECONET SYSTEM TECHNICAL ENQUIRIES	ALAN LAFFOLEY
ACCOUNTS	CARON ANDREWS
DESPATCH	PAUL SWIFT
REPAIRS	JOHN MAULE

Prices Correct at the time of this advertisement going to press.

## BUSINESS SYSTEMS



### APRICOT - SIRIUS - SANYO IBM - TEXAS - TORCH

**APRICOT** "Portable Executive Computer". 16 Bit Micro, 256K RAM, up to 1.44 megabytes floppy disk storage, 3 1/2" Sony disks. Portable brief case styling. Modem with auto dialler (optional) hard disk optional. Vast software library (compatible with Sirius 1).  
Apricot with Single Drive and Monitor £1690 + VAT  
Apricot with Double Drive and Monitor and Free Printer or 2nd Monitor £1890 + VAT

**SANYO PROFESSIONAL COMPUTER**  
16 Bit Micro 128K RAM expandable to 256K. Single or Double Disk Drive, built in full colour graphics (640 x 200 pixels in 8 colours) IBM compatible. Free software. Sanyo MBC 550 128K RAM single drive and free software including Wordstar and Calstar £749 + VAT  
Sanyo MBC 555 128K double drive and free software including Wordstar, Calstar, Infostar Dastatar etc. £999 + VAT

**SIRIUS 1** Sirius 1 Computer with 128K RAM and 1.2 megabyte Floppy disc storage including CP/M 86, MS DOS and Microsoft Basic £2195 + VAT

Sirius 1 Computer with 256K RAM and 2.4 megabyte Floppy disk storage including C. C/M 86 MS DOS & Microsoft Basic £2895 + VAT

**TORCH**  
**CF500 COMPUTER** with colour monitor includes Twin 400K disks, Torchnet Operating System free perfect software (perfect writer, perfect speller, perfect calc, perfect filer), Torchmail Plus (Electronic Mail), Torch Mars (Financial modelling with graphics), Torchnet (Viewdata Access System) Executive Aid (Menu System)  
Data! 600 (Link to outside mainframe services i.e. Telecom Gold) £2950 + VAT

**TEXAS INSTRUMENTS PROFESSIONAL COMPUTER**  
TI 502 Dual 320KB Drives 256K RAM. Up to 10 megabyte on board storage possible. TI speech command hardware option brings a new level of user friendliness to computing. Allows voice operated keyboard control (Optional). Price £2650 + VAT

MAINTENANCE CONTRACTS ARE AVAILABLE.

## COMPLETE WORDPROCESSING SYSTEMS INCLUDING DAISYWHEEL PRINTER From £695 + VAT

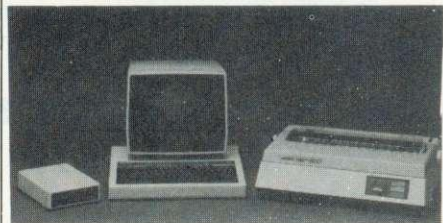

**SYSTEM 1** BBC Micro model B, Wordwise, Phoenix monitor, Smith Corona TP1 Daisywheel Printer, Cassette Recorder + all the necessary cables and documentation £696 + VAT = £799.25

**SYSTEM 2** BBC Micro model B + Disk Interface, Phoenix Monitor, 100K Single Disk Drive, Wordwise, Smith Corona Daisywheel Printer + all the necessary cables and documentation. Price only £895 + VAT = £1029.25

**SYSTEM 3** BBC Micro model B + Disk Interface, Phoenix Monitor, Dual Disk Drives 200K, Wordwise, Smith Corona Daisywheel Printer + all the necessary cables and documentation. Price £999 + VAT = £1148.85

**SYSTEM 4** BBC Micro model B + Disk Interface, Sanyo High-Res Green Monitor, Wordwise (or view), Juki 6100 Daisywheel Printer, Single 400K Disk Drive + all the necessary cables and documentation. £1049 + VAT = £1206.35

**SYSTEM 5** BBC Mod B Micro + Disk Interface, Sanyo High Res Green Monitor, Wordwise (or view), Juki 6100 Daisywheel Printer, Dual Disk Drive 800K + all the necessary cables and documentation. Price £1195 + VAT = £1374.25

**SYSTEM 6** Sanyo 16 Bit, IBM pc Compatible Micro, 128K RAM, Single Disk Drive 160K, Wordstar, Calc Star, Sanyo High Res. Green Monitor, Juki 6100 Daisywheel Printer + all cable and documentation. Price Only £1145 + VAT = £1316.75

**SYSTEM 7** Sanyo 16 Bit, IBM pc Compatible Micro 128K RAM, Dual Disk Drives 360K, Wordstar, Calc Star, Mailmerge, Infostar, Spellstar Dastatar, Sanyo High Res. Green Monitor, Juki 6100 Daisywheel Printer - and all necessary cables and documentation. Price £1395 + VAT = £1604.25

**SYSTEM 8** All the components of System 6 but with Sanyo High Res Colour Monitor and Wordstar with Colour Facilities. Price £1445 + VAT = £1661.75

**SYSTEM 9** All the components of System 7 but with Sanyo High Res Colour Monitor and Wordstar with Colour Facilities. Price £1695 + VAT = £1949.25

WE CAN ALSO SUPPLY PACKAGES WITH COMPONENTS OF YOUR OWN CHOICE. PLEASE PHONE (0279) 412639 AND ASK FOR HAMAYUN MUGHAL FOR A PRICE.

## ORDERING INFORMATION:

We accept official orders from UK Government and Education establishments. Carriage is Free (UK only) for normal delivery. If express delivery is required please add £8.00 + VAT per parcel. We accept telephone orders on Barclay and Access Card please ring (0279) 443521 (10 lines). All cheques made payable to "AKHTER INSTRUMENTS".

N.B. ALL VAT INCLUDED PRICES ARE THE CORRECT PRICES. EXCL. VAT PRICES HAVE BEEN ROUNDED UP TO NEAREST POUND.

OPENING HOURS: MON-FRI 9am-6.30pm, SAT 10am-5pm  
We welcome callers, no parking problems.

# Robot Plotter

**£59.50**  
INC. VAT  
CARRIAGE  
£3.00

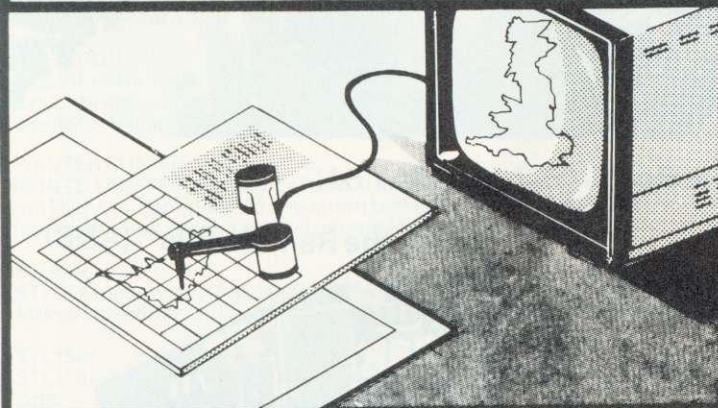

- ★ FOR BBC MICRO MODEL B CASSETTE OR DISC
- ★ ENABLES PICTURES TO BE DRAWN OR TRACED
- ★ WORKS IN ANY GRAPHICS MODE — COLOUR SELECTABLE
- ★ DESIGNED BY A TEACHER FOR EDUCATIONAL USES BY STAFF AND PUPILS
- ★ TRANSPARENT TABLET ALLOWS DIAGRAMS AND MAPS, ETC. TO BE COPIED
- ★ ROUTINE INCLUDED TO SAVE QUICKLY TO DISC OR CASSETTE
- ★ SCREEN DUMPS FOR EPSON AND SEIKOSHA PRINTERS
- ★ TRIED AND TESTED — DIRECT FROM THE MANUFACTURER

**COMMANDS FOR:**

LINES  
CIRCLES  
RECTANGLES  
INFILLING  
COPY AND MOVE  
PRINT AT  
AS WELL AS TRACE MODE

Please send me .....

I enclose Cheque/P.O. for .....

Name .....

Address .....Code .....

GOVERNMENT AND EDUCATIONAL ESTABLISHMENT  
OFFICIAL ORDERS WELCOME



**COMPUTER DEVELOPMENTS LIMITED**

NATIONAL INDUSTRIAL ESTATE  
BONTOFT AVENUE, HULL HU5 4HF  
TEL: (0482) 448562.

## AT LAST. THE VITAL LINK BETWEEN PHYSIOLOGICAL DATA AND YOUR BBC MICRO.

The Harvard Universal Data Interface is a transient store that links the BBC Micro to an oscilloscope, a chart recorder, a dot matrix printer, a biological pre-amplifier, a human subject, a biological preparation, a stimulator, an X-Y plotter, a TV monitor and a disc drive.

The Universal Data Interface:

- Accepts analogue data in the frequency range DC to 6KHz.
- Typical applications include ECG, EMG, EEG, Evoked Response Extra-cellular and Intra-cellular recordings.
- Has available a complete range of software.
- Costs just £450. (exc. VAT P&P extra).

For full details contact Harvard Apparatus at the address below.

**Harvard**

**FURTHERING THE REALMS OF RESEARCH.**

Harvard Apparatus Ltd., Fircroft Way, Edenbridge, Kent TN8 6HE.  
Tel: (0732) 864001. Telex: 95293.

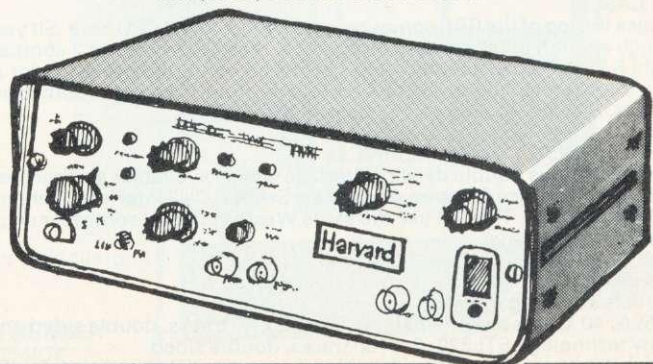

# SOLIDISK SIDEWAYS RAM: 8,000 UNITS SOLD

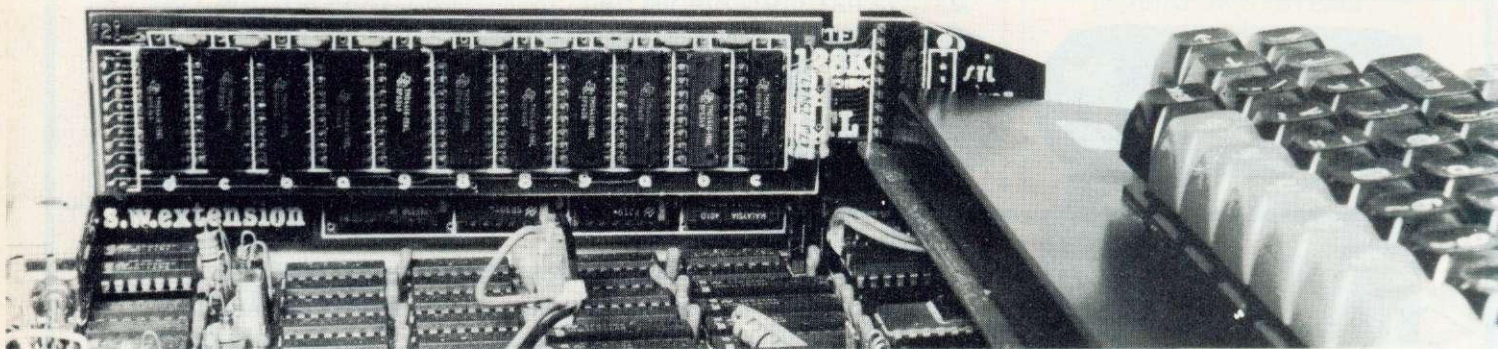

"Exciting" (ACORN USER JAN 84), "Power to your Beeb" (PCN 61, MAY 84)

## HOW ABOUT COMPATIBILITY?

The Sideways RAM is completely compatible with all issues of BBC computers, disks, all sideways ROMs, second processor, Torch disk pack, Teletext, Econet etc. but NOT with ROM extension boards, since it can replace them.

Its power consumption is so low that you can use it in conjunction with twin disks.

## HOW DOES IT WORK?

Occupying the same place as sideways ROMs (such as BASIC, DFS, CPN etc), it is treated like other Sideways ROMs and therefore can replace them.

The Machine Operating System uses Sideways RAMs as naturally as Basic, without procedures or programming rules.

Sideways RAM can run any language, any filing system including Hi-Basic and second processor DFS.

## SIDEWAYS RAM POWER IS IN THE SOFTWARE:

Different from Sideways ROMs, Sideways RAM can be written into. This property gives birth to a NEW GENERATION of software for the BBC computer: SERVICE RAMs and VIRTUAL MEMORY PROCESSOR.

Each SERVICE RAM has its own commands and code as its counterpart Sideways ROM but has its own private workspace and storage area thus leaving you with the lowest possible PAGE value (PAGE = &E00). On the other hand, the Virtual Memory Processor can run huge MACRO BASIC programs (Megabytes are not the limit), keep them on disk and uses the basic 32k of RAM as transient program area. All software for the Sideways RAM system is free.

## FREE SOFTWARE?

Solidisk Sideways RAMs is bundled with lots and lots of software, FREE and we mean FREE, now and later. It is quite simple: for every Sideways RAM sold, £1 is spent on MORE software. Sideways RAM users are invited to spot new applications and contributions are rewarded at the usual rate of £1 for every 4 bytes of machine code.

The result is printed on the opposite page.

## HOW ABOUT THE FUTURE?

Solidisk Sideways RAM is also widely used in schools for ECONET stations, by professional programmers for writing programs, research laboratories for RAM disk data base, at home for wordprocessing and now even games.

New areas are being developed: Telesoft and Teletext logging, Speech Processor assembler and Relational Data base to cite a few.

As the price of 16k EPROMs are as high as £20 at the present time, more Sideways ROM software publishers will be willing to sell their software on disk. Solidisk will mail FREE OF ANY COST their advertisement to ALL Sideways RAM users providing the price of the Disk version reflects savings in the cost of the ROMs. Solidisk believes that the majority of BBC users will have their Sideways RAM fitted before the end of next year.

Also unlike other makes (SIR, APTL, WE Sideways ROM/RAM extension boards and the Aries B20), Solidisk Sideways RAM is expandable from 16k right to 128k and now to 208K. As a result of VLSI technology and volume of sales, Solidisk products also have a lower shop price than any other products.

## OTHER PRODUCTS FROM SOLIDISK:

### UVIPAC EPROM ERASER:

Uvipac is powered by the mains, simple to operate and can erase 3 Eproms of any type in just 15 minutes. Uvipac is ideal for home use.

### DETACHABLE KEYBOARD CASE:

Remove the keyboard from the BBC computer and instal it in the new case. Replace the old 3" keyboard tail by the new 24" cable and you can work really in comfort even for very long hours. The keyboard case is more a productivity tool than just ergonomics.

### CPU CASE:

Replace the top of the BBC computer case by this metal CPU case. Sit your monitor on top (it is tough enough to take even your weight!). The CPU case has 2 compartments for half height 5.25" disk drives with fixing screws, air vents and provision for a bolt-on fan. At first sight, there is no trailing wire. Looking inside, there is enough room to accomodate Teletext Adapter, Second Processor, Solidisk and a fan!

### DOUBLE DENSITY DISK INTERFACE:

2 versions of this double density interface will be available: as direct replacement for the Acorn Disk Interface (Version A) and as a Second Disk Interface (Version B) adding to your existing interface. They all use the same Western Digital controller chip (WD1770). Price £39.95 inclusive

### DISK DRIVES:

3 models are being offered:

STL55A: 40 tracks single sided, SLT55F: 2 x 80 tracks, double sided and the best of mini floppy technology STL320: 2 x 160 tracks, double sided.

All disk drives are supplied with cables, formatter disk, head cleaning kit and 2 year warranty.

## "Break the Ram Barrier" (A&B)

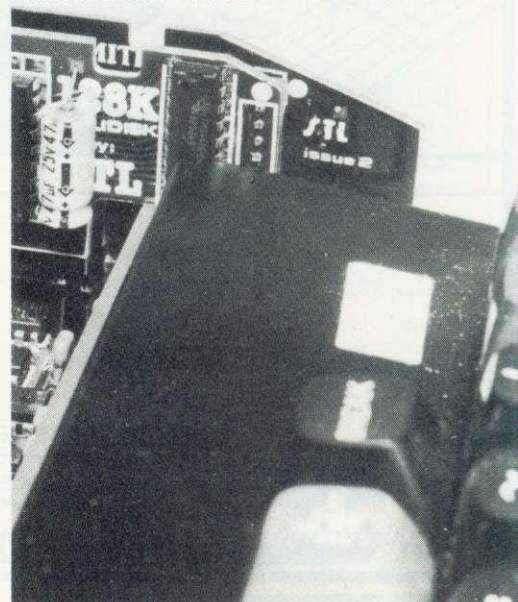

UVIPAC EPROM ERASER



TEAC DISC DRIVES FD55 Series

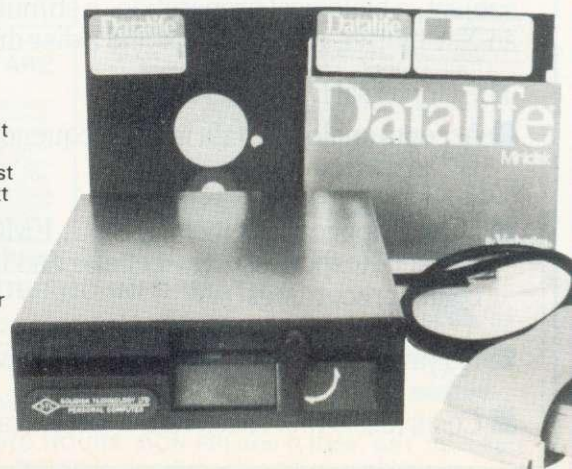



# WHICH SIDEWAYS RAM DO YOU NEED?

HOW EASY TO INSTALL:

Solidisk Sideways RAM is available in 16 (SWR16), equivalent to 1 sideways ROM, 32k (SWR32), equivalent to 2 sideways ROMs, 128k (Solidisk), equivalent to 8 sideways ROMs and the 208k Solidisk equivalent to 12 Sideways ROMs. You can buy a small Sideways RAM now and upgrade it later. From the SWR16 to the SWR32 is by straight exchange, from the SWR32 to the Solidisk is by adding the 96k Solidisk Extension, from 128k to 208k is by exchange of the RAM card.

## FREE SOLIDISK SOFTWARE:

### WORD64:

WORD 64 is a Service RAM, it uses Solidisk as storage for WORDWISE, up to 64K free characters for any text.

### SILEXICON:

SILEXICON is a Spelling Checker for Solidisk. SILEX scans texts at more than a 1,000 words a minute and compares each word against the dictionary, Silexicon marks the mis-spelt words for either addition to the dictionary or eventual correction.

### PRINTER BUFFER:

PRINTER BUFFER is a Service RAM, it increases 500 times the normal 32 bytes printer queue to 15K bytes, completely transparent to the user. PRINTER BUFFER is as useful for printing a long document as for a short program listing.

### STLEOO:

STLOO is a Service RAM, it is Disk Filing System that leaves PAGE at &E00, has built-in disk formatter/verifier and automatic track stepping for 40/80 track disk drives.

### STL150:

STL150 is a Service RAM to enhance Acorn's .90 DFS to offer up to 150 directory entries per side.

### STL-RFS:

STL-RFS (RAM/ROM filing system) is a Service RAM and an innovation in portable applications. STL RFS saves any program in a Sideways ROM format, it can then be copied onto EPROM to give instant recall of your programs. Plug this EPROM into any sideways socket, type \*RFS and it runs itself. Compatible with the ELECTRON and BBC, tape and disks, SWR16, SWR32 and Solidisk.

### INDEX:

INDEX is a Service RAM, it stores all the entry points of one or several sequential data files such as mailing list, stock list, accounts etc, merges, sorts them in alphabetical order and gives instant access to any record. INDEX can handle 1,100 records of any size, any type, any number of fields.

### MACRO-BASIC:

MACRO-BASIC is a program generator. You use a wordprocessor to create a command file which is then scanned by MACRO. MACRO uses other programs, subroutine libraries, text files (actually any or all files on your disks) as source to generate a bug free BASIC program which can be very large (Megabytes are not the limit).

### VIRTUAL MEMORY PROCESSOR:

VIRTUAL MEMORY PROCESSOR (VMP) uses extensively overlay technique and Solidisk as back store for very large programs that cannot be run otherwise. VMP uses the 32k basic RAM as transient area: it operates on a Main Program as generated by MACRO-BASIC, taking different segments from the Solidisk Store, POOL, HOLD, FREE or CLEAR segments from the transient area. For example: VMP will accept 20 segments of 10k of Basic assembler and assembles it into 16k of machine code.

### MENU:

MENU puts all computer's resources at your fingertips. MENU displays your Sideways Firmare, Disk Directories, Sideways RAM system, Solidisk System etc.

### MORE FREE SIDEWAYS RAM SOFTWARE TO COME:

While others are making promises for software to be written, Solidisk Systems RAM comes with a complete, novel and powerful software package including compatibility with existing sideways software.

Each Sideways RAM is accompanied by the Sideways RAM User Manual, full 1 year warranty, 1 utility disc\* and free mailing on all new publications from the Software Support Service.

\*It should be understood that we cannot put as much free software on a 40 track single sided as on 80 tracks. The present software package require 160 tracks of storage and can be accommodated on ONE 2 X 80 track double sided diskette, only the most useful programs are supplied on other formats (ie 40 track single sided, 2 X 40 track double sided, 80 track single sided). Should you require the whole collection of free software, please place an order for extra disks. For the technical minded: the Source Code and Technical Manual (3 floppies and a 300+ page book) price = £10, the SILEXICON EXTENSION PACKAGE (3 floppies and a 40 page manual, 30,000 word dictionary: English and French now, German and Spanish planned) price = £9.00. '4S' also publishes regular updated SWR utility discs at £3.00. Every user can do contract work for the SUPPORT SERVICE and make a lot of money for him/herself!

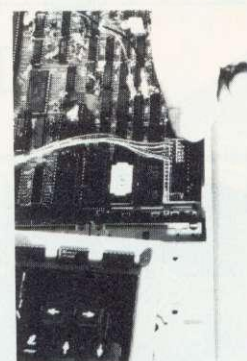

Push in the base unit

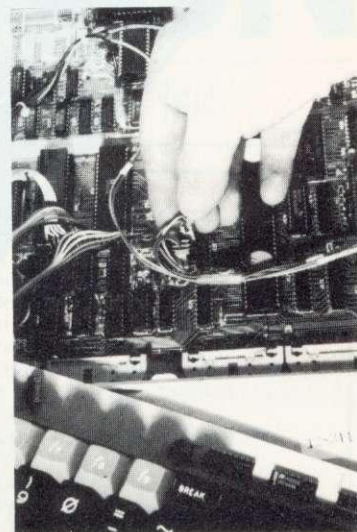

Connect the control wires

### PRICE LIST (including VAT and post & packing)

SIDEWAYS RAM:	
SWR 16K	£43.65
SWR 32K	£59.95
128K SOLIDISK	£150.95
208K SOLIDISK	£243.00

The following are upgrade prices for existing Sideways Ram owners:

16 - 32 (please return complete item)	£18.00
16 - SOLIDISK (please return complete item)	£109.00
32 - SOLIDISK (no return necessary)	£93.00
128K - 208K SOLIDISK	£93.00

### DISK DRIVES:

STL55A (40 track, single sided, cased with cables, diskette, manual and 2 years warranty)	£142.95
STL55F (2 X 80 track, double sided, as above)	£232.95
STL320 (2 X 160 tracks, double sided, as above)	£499.00

### FLOPPY DISKS (DATALIFE Verbatim):

MD525 (SS/DD 40 or 80 track) box of 10	£16.00
MD550 (DS/DD 40 or 80 track) box of 10	£22.00
MD557 (DS/DD 98 TPI) box of 10	£27.00

### CPU CASE

DETACHABLE KEYBOARD CASE	£13.00
	£27.99

### EPROM PROGRAMMER (used with Sideways Ram)

UVIPAC EPROM ERASER (free standing unit)	£20.95
2764 PACK OF 5	£36.00

### SOURCE CODE + TECHNICAL MANUAL

SILEXICON EXTENSION PACKAGE	£10.00
	£9.00

**WE STOCK A LARGE RANGE OF PRINTERS AND MONITORS. CALL OUR SALES OFFICE FOR IMMEDIATE QUOTATION.**

## HOW TO ORDER?

You can order any item using the coupon. Post and packing is only charged once. Access and Barclay card holders can place their order by phone. Educational authorities, Acorn dealers and OEMs can obtain quantity discounts.

Name: .....

Address: .....

Credit Card Account: .....

Callers are requested to ring first for appointment.

Total: £

If ordering more than one item, deduct £1 per item as post and packing cost is only charged once.

**SOLIDISK TECHNOLOGY LIMITED**  
17 SWEYNE AVE  
SOUTHEND-ON-SEA  
ESSEX SS2 6JQ

**SOLIDISK'S NEW TELEPHONE NUMBER:**  
SOUTHEND-ON-SEA (0702) 354674  
(10 lines with automatic exchange)

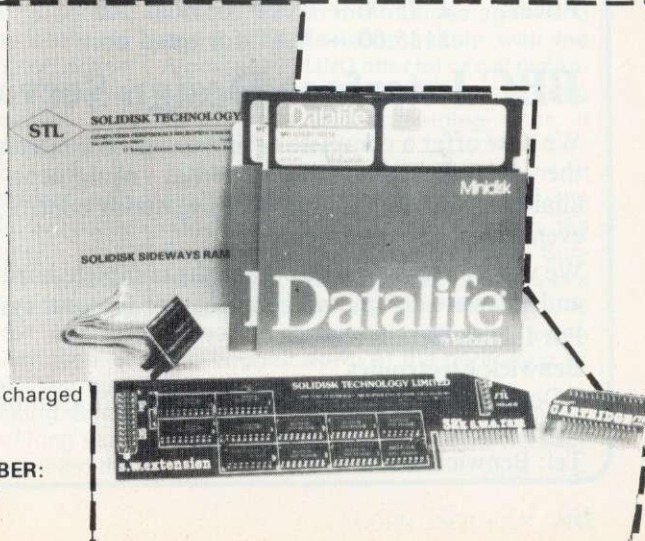

# SINGLE BOARD 6809 2nd PROCESSOR FOR THE BBC MICRO.

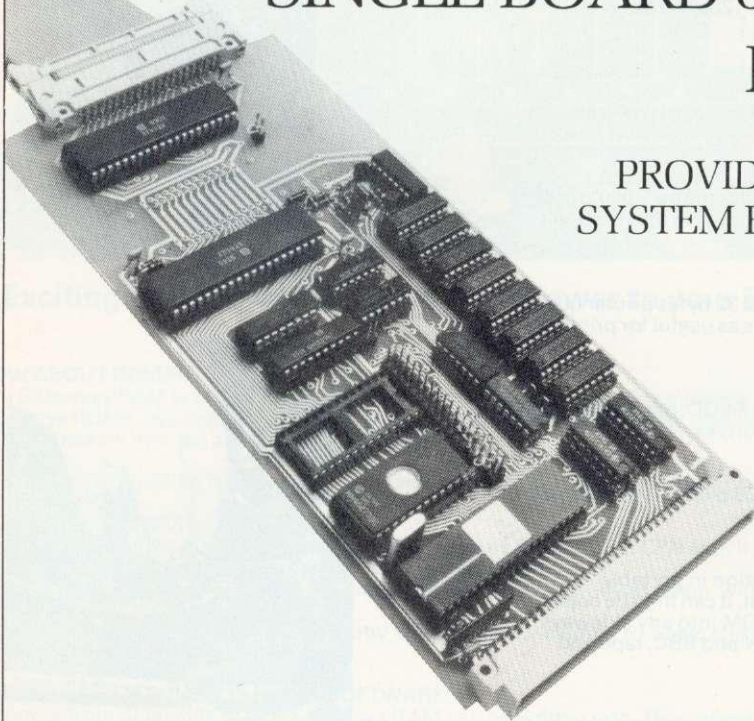

PROVIDES A LOW-COST DEVELOPMENT SYSTEM FOR INDUSTRIAL APPLICATIONS.

- Sits inside the BBC or plugs into an extension rack
- Enables standard Flex format Discs to run on BBC
- Supports High Level Language Compilers
- Cross Assemblers and Disassemblers for most micros
- Connects directly on to the tube
- 64k DRAM on board
- Two 28 pin byte wide memory sockets
- Acorn Bus compatible DIN 41612 Bus interface
- Also available as a single board controller

For full information contact Phil Taylor at:

**EMS**

44a Hobson Street  
Cambridge CB1 1NL  
Tel. 0223 324141

Cambridge  
Microprocessor  
Systems Limited

## Disc Drive Multiplexer

- ★ NO SWITCHES
- ★ NO SOFTWARE
- ★ NO EXTRA CABLES OR CONNECTORS

This is the simple low cost alternative to buying disc drives for every BBC. This unit allows the connection of up to 4 BBC Computers to the same disc drives. The operation is total automatic because it uses one of the disc interface outputs to electronically switch between computers. The computer will simply wait for access to the drives if they are in use. All the DFs commands are used as normal. It is ideal for use in schools and offices and saves having to purchase 1, 2 or 3 dual drive for about £500 each. The unit is complete with its own power supply.

Prices: £ 75.00 + VAT for dual unit  
£135.00 + VAT for quad unit,

## BBC Interface Design Service

We now offer a complete design service for interfacing the BBC Computer to external equipment, e.g. analogue and digital multiplexing, motor control, and even complete experiments.

We will be pleased to quote for the complete hardware and software design and manufacture for your system.

For further details contact:

**Benwick Electronics**  
9 Doddington Road, Benwick, Nr. March, Cambs.  
PE15 0UX.  
Tel: Benwick (035477) 471

Educational  
Engineering  
Mathematical  
Scientific

## PROGRAMMING

PROBLEMS WITH METRIC OR SI UNITS?

UNIVERSAL UNITS CONVERTOR

The METRICATOR suite of programs for the BBC-B and ELECTRON may be your answer. Can convert ANY unit into ANY other compatible unit eg. KM/LITRE into MILES/GAL or BTU/HOUR/FT<sup>2</sup> into JOULES/SEC/M<sup>2</sup>. "SI" may be specified and the correct SI equivalent automatically calculated. You do not need to know it. Saves hours of work.

15 UNIQUE routines designed for EASY insertion into YOUR program give instant access to many thousands of combinations of units.

Multiples and sub-multiples (mega, micro, nano etc) all handled automatically. Your own units may be added.

Tape and disc versions available. Both contain a library of units, a program to give immediate conversions and a demonstration program to produce conversion tables. Disc version uses a random access file to reduce RAM requirements and BINARY CHOPPING for VERY fast access.

All techniques including data packing fully explained in detail. The routines are written to a VERY high standard. We are so confident that we GUARANTEE to include ANY conversion you specify when ordering.

NEED ANYTHING? Contact us for any mathematical or scientific methods. We either have it or will find it.

WANTED! more mathematical and scientific programs and routines of METRICATOR standard. Send yours to us for evaluation (tape or printed listing and example run).

METRICATOR Prices (Inc p&p)

Tape version-----£6.95.  
Disc version (Acorn standard 40 track) -----£9.95  
including supplementary disc file and  
maintenance programs-BBC only.  
Instruction manual and program listing only-----£3.75  
(refundable against subsequent program purchase).

Remittance to:-

"EMS Programming"  
134 Buckswood Drive  
Crawley  
Sussex, RH11 8JG.

Please state BBC or ELECTRON.

# ACTION SEQUENCE FOR CONVERSION

Barry Pickles finalises his Basic translation kit

IN THE first two parts of this series we listed some of the keywords in BBC Basic, explaining how they can be converted for the Atom, and we discovered which VDU calls have an Atomic equivalent. Before we get down to actually translating a BBC Basic program into AtomBasic, however, let's consider \*FX calls and the problematic conversion of machine code from one micro to the other.

A full summary of \*FX calls was published in the November '82 issue of *Acorn User*. The ones that can be used are given in table 1. In conversion most calls can be ignored as, generally, they are not essential to the running of a program, even though they are performing sophisticated functions. \*FX calls are also used in the form  $A\% = \&XX$ : CALL OSBYTE, where XX is the number corresponding to the \*FX call.

*FX	Atom equivalent
6,x	?#FE = x
19	LI.#FE66
119	SHUT#
121	INKEY (see text)
132	Same as HIMEM
133	Always #8000 on Atom
134	$A = ?\#DF * 256 + ?\#DE + ?\#E0$
135	?A (where A is as above)
150/151	Read/write SHEILA

Table 1. \*FX calls

Machine code is the most difficult of all to convert, since most machine-code routines nowadays use machine specific OS calls to save coding. The only way to deal with this is to ascertain what the code is doing (if you're lucky, from a program description) then write your own code, using Atom OS calls. You will find, in published programs at least, that the same calls are used repeatedly and with time you'll become used to them. You will also find that few non-BBC programs are in assembler format. Most POKE the op-codes and data directly into memory. If the code is for a 6502-based machine (Apple, Atari, Commodore 64, Oric, Pet, Vic) you can do this yourself, then disassemble it to see whether you can make sense of it.

You will further find that few BBC programs make direct calls to OS routines and ports; instead, they use indirection, either through block zero or OSBYTE (see above). OSBYTE corresponds to location &FFF4 and can address three blocks, known as FRED, JIM and SHEILA. FRED is page &FC, JIM is page &FD and SHEILA is page &FE. Calls to the FRED and JIM areas access the Beeb's 1MHz bus and, if the program does this, it is non-convertible.

Reading and writing to SHEILA allows access to various internal chips and conversion may be possible if you know what it's doing. One area of memory that can be easily converted is associated with the user port (VIA), mapped at &FE60-&FE6F, directly corresponding to &B800-&B80F on the Atom. Calls are made through the A and X registers.  $A\% = \&96$  performs a read, while  $A\% = \&97$  does a write. The X register is used as an offset from &FE00, thus:

```
LDA &X96
LDX &X60
JSR &FFF4
```

reads location &FE60, which is port B of the VIA.

Converting machine code is a matter of practising until you get proficient at it.

To convert a program successfully, it helps to follow a plan of action.

First, read through the program, using the outline description if there is one, and break it down into short action sequences, writing each one down and the line numbers where it occurs. This is like preparing a flow-chart in reverse. Mark the sequences that you think will convert without much problem and note any in which AtomBasic will allow you to program more efficiently.

Now make a list of every variable used, its type (integer, string or floating point) and what it is used for. Against each one, allocate a similar type of Atom variable. This is where you may need to do some lateral thinking. Since most Basics allow the use of long variable names and recognise at least the

```
0 REM Cubes
5 REM (C) Acornsoft 1982
20 MODE 1
30 VDU5
40 VDU19,2,4:0;
50 REPEAT
60 FOR Y%=0 TO 1200 STEP 10
70 H% = 1100 - RND(Y%)
80 PROCCUBE(RND(1300) - 50, H%,
(1200 - H%) / 6, RND(4) - 1)
90 NEXT
100 VDU19, RND(3), RND(7); 0;
110 UNTIL FALSE
120 DEFPROCCUBE(X%, Y%, S%, C%)
130 D% = S% / 3: E% = S% * D%
140 VDU29, X%, Y%;
150 GCOL0, C%
160 MOVE0, 0: MOVE0, S%:
PLOT85, D%, E%
170 MOVE0, 0: PLOT85, E%, E%
180 MOVE0, 0: PLOT85, E%, D%
190 MOVE0, 0: PLOT85, S%, 0
200 GCOL0, C% + 3
210 DRAW S%, S%: DRAW0, S%:
DRAW 0, 0: DRAW S%, 0
220 MOVE0, S%
230 DRAW D%, E%: DRAW E%, E%
240 DRAW E%, D%: DRAW S%, 0
250 MOVE S%, S%: DRAW E%, E%
260 ENDPROC
```

Listing 1. 'Perspective' series of overlapping cubes drawn from top to bottom of screen by a BBC Basic program from 'Creative Graphics on the BBC Micro'

first two characters as significant, you will often find that more than Atom's 27 variables are needed. You can always use arrays and, for tables, byte and string indirection may be a better solution.

Next, look at the routines again and see if any are incompatible with the Atom (eg, SOUND effects) or not essential to the program. Delete these - you can always add something later, if memory allows.

Now you are ready to begin. Convert each routine separately and test the conversion before proceeding to the next one. Do the easy ones first. Successfully converting three-quarters of a program gives you the incentive to tackle the remainder, rather than getting bogged down at the beginning by attempting the difficult bits.

Listing 1 is a BBC Basic program, again taken from the Acornsoft book

# BBC SPEECH

## PRICE BREAKTHROUGH

### Speech Synthesizer For The BBC Computer

Totally unlimited vocabulary is now possible with the revolutionary "SWEET TALKER" Speech Synthesizer for the B.B.C. A or B Microcomputer, any series.

The CHEETAH "SWEET TALKER" simply plugs into speech socket IC99 within the computer.

No soldering, no cutting of tracks, no headaches.

Based on an allophone system you can easily program any word, sentence or phrase and incorporate speech into your software games.

Fully tested and guaranteed.  
Complete with demonstration cassette and full instructions.

*Price includes V.A.T., Postage and Packing.  
Delivery normally 14 days.  
Export orders at no extra cost.  
Dealer enquiries welcome.*

*Send cheque/PO now to:-*

Simply  
Incredible at

**£24.95**

**CHEETAH MARKETING LIMITED**  
Dept. AU3, 24 Ray Street, London EC1. Tel: 01 833 4909

*Cheetah, products available from*

branches of **John Menzies** *Boots* **WHSMITH** and **Rumbelows**

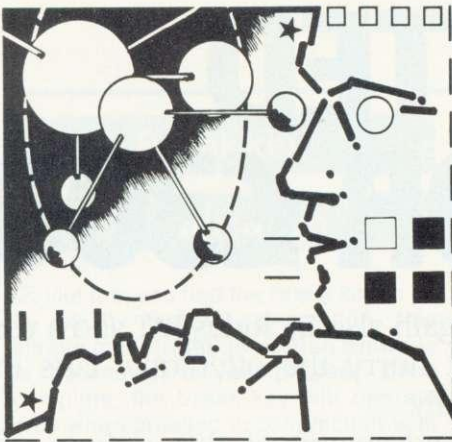

Barry Pickles this month pays good money for mode 4 text, a break key mod, a line deleter and a disc utility to recover lost data

**£20 Text plotting in mode 4**

HAVING said recently how complicated it was to write in text 4, along comes our old friend Jeff Carter (now living in Ponderosa territory) to prove me wrong. It's not exactly Helvetica - Acorn User's typeface - but it works, and earns Jeff £20. Over to you, pardner:

After reading the Atom Forum's article on Mode 4 text (November issue), I thought I'd send you the system I have used, which is much less memory-intensive than the methods presented, requires no assembly language and permits the size of the characters to be varied. Its drawbacks are that it's somewhat slow and the characters look rather strange (especially K, Q, V and X).

The routine is given in listing 1. It plots one character at the current graphics position and resets the graphics position to five pixels to the right of the character.

The L vector contains one byte for each digit and two bytes for each upper-case letter. The seven least-significant (rightmost) bits of each byte are used to control whether the segments of a seven-segment 'display' are on or off:

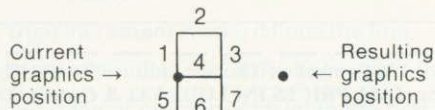

The zero (least-significant) bit controls segment 1, and the sixth bit controls segment 7. A one means the segment will be plotted; a zero, the segment will not be plotted. Digits are plotted as one seven-segment 'display', letters as two 'displays' with two common segments. Figure 1 shows the character set that I've defined.

The factor of five given in the plot statements is the length of one segment and produces fairly large characters. Digits are 6 x 11 pixels and letters are 11 x 11 pixels. This factor can be

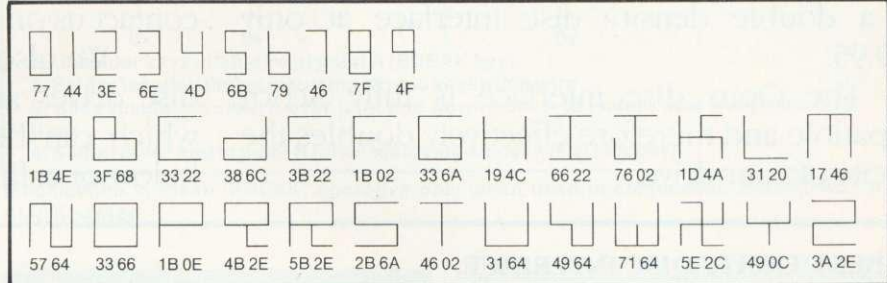

Figure 1. The character set

any value in the range 2 to 95. Any smaller and garbage will be plotted; any larger and the characters will be too tall for the display (and only partially plotted).

I got the idea of using the bits of a byte to control a seven-segment 'display' from a biorhythm program published in an Atom user group newsletter. I designed this character set and

wrote the routine to select the controlling byte(s) from a character's ASCII code.

The routine is not limited to mode 4. It will work in any graphics mode, including colour modes. The size and shape of the characters will differ from mode to mode if the plot statements are not altered.

Page 125 ▶

```

5 REM MODE 4 CHARACTERS
10 DIM L(63), A(10)
20 IL = #6E3F4477; L14 = #46796B4D
30 L18 = #4E1B4F7F; L112 = #22336B3F
40 L116 = #223B6C38; L120 = #6A33021B
50 L124 = #22664C19; L128 = #4A1D0276
60 L132 = #46172031; L136 = #66336457
70 L140 = #2E4B0F1B; L144 = #6A2B2F5B
80 L148 = #64310246; L152 = #64716449
90 L156 = #0C492C5E; L160 = #2E3A
99 REM DEMONSTRATION ROUTINE
100 $A = "ATOM"
110 CLEAR 4; MOVE 10, 95
120 FOR I = 0 TO LEN(A) - 1
130   C = A?I; GOSUB C
140 NEXT I
150 LINK #FFE3; PRINT $12
160 END
999 REM CHARACTER PLOTTING ROUTINE
1000 IF C = 32; PLOT 0, 10, 10; RETURN
1010 IF C < 48; RETURN
1020 C = C - 48; IF C < 10; GOSUB e; PLOT 0, 5, 0; RETURN
1030 C = C - 17; IF C < 0 OR C > 25; RETURN
1040 C = 2 * C + 10; GOSUB d; PLOT 0, 5, 0; RETURN
1099 REM UPPERCASE LETTER PLOTTING ROUTINE
1100 d = C; GOSUB e
1110 C = 0 + 1; GOSUB e; RETURN
1199 REM ONE SEVEN-SEGMENT "DISPLAY" PLOTTING ROUTINE
1200 e C = L?C; PLOT (C&1), 0, 5
1210 C = C/2; PLOT (C&1), 5, 0
1220 C = C/2; PLOT (C&1), 0, -5
1230 C = C/2; PLOT (C&1), -5, 0
1240 C = C/2; PLOT (C&1), 0, -5
1250 C = C/2; PLOT (C&1), 5, 0
1260 C = C/2; PLOT (C&1), 0, 5
1270 RETURN
    
```

Listing 1. Mode 4 characters

**Invented a routine or discovered a hardware modification for the Atom? Here's a chance to show your originality and win some cash. Send your idea to: Atom Forum, Acorn User, Redwood Publishing, 68 Long Acre, London WC2 9JH.**



£10

## Break key

### modification

IF, like me, you find the break key to be in exactly the wrong position, this simple mod. (right) from Alan Knowles is the answer to your prayers. Once complete, the break key will operate only when pressed in conjunction with the CTRL key. It wins Alan £10.

£5

## Fast deletion

### of program lines

A FIVER goes to Colin Hollyman of Fareham, Hants, for his time-saving line-remover utility. He writes:

The *Atomdel* program in December's *Acorn User* certainly is a useful utility. It is usually faster to get the computer to delete unwanted lines and it is less likely to lead to errors. But how many programmers will take the time and trouble to find the right tape, find the place on the tape and load the program, just for the sake of deleting a few lines?

I have a simple routine which can be used to remove any number of lines, provided they are at the end of the program, and temporary lines – eg, aids to debugging or data for testing – can usually be written as a subroutine at the end of the main program.

Suppose all lines after 1000 (included) are to be deleted. Change line 1000 by entering

```
1000@ (RETURN)
```

The new line should contain no spaces and any character (other than a number) can be used.

Set a pointer to the start of the current text space

```
A = #2900
```

Then increment A until it finds the line  
DO A = A + LENA + 3; UNTIL \$A = "@"

using the character entered in the first line to be deleted. Set the 'end of program' pointer

```
?(A-2) = 255
```

and then reset TOP by

```
END
```

On listing, all lines with a line number 1000 and greater will have been deleted.

All this, except the change to line 1000, can be abbreviated and entered directly as one line:

```
A = #2900; DOA = A + LENA + 3; U.$A = "@"; ?(A-2) = 255; E.
```

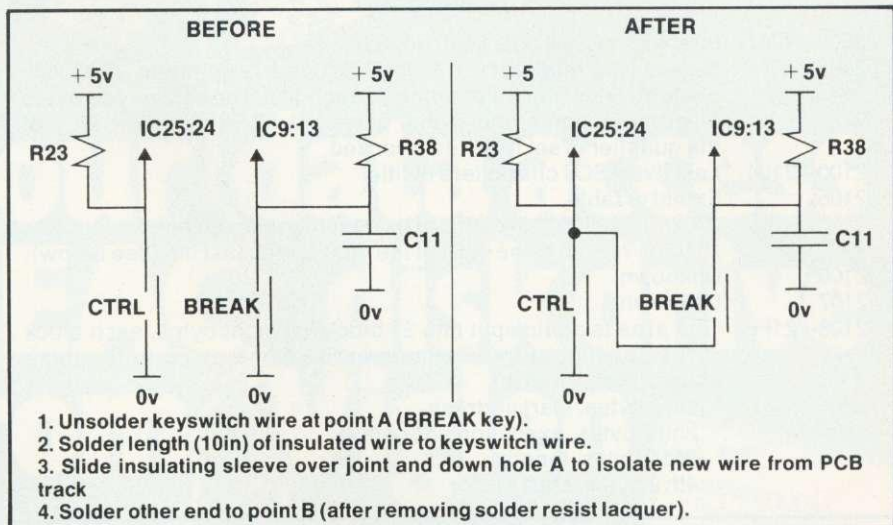

Modification to make 'BREAK' operative only when used in conjunction with 'CTRL', by Alan Knowles

## £20 Utility to recover lost data

DAVID LAKE of Newbury hopes his disc utility will be as useful to readers as it has been to him. It earns him our £20 accolade. Let David explain:

I would be surprised if any owner of an Atom disc system can say that he has never lost a valuable program by accidentally corrupting a floppy. This may occur if a floppy is left in the drive on power-up, for example, or upon interruption of the power supply during a disc write operation. Another maddening cause of lost data is failure to type a space as a qualifier after the \*SET command. The short program in listing 2 is a disc utility designed to help recover that lost data.

The most usual cause of a corrupted floppy is an error in the first sector,

which is where the catalogue is stored. If the disc operating system is unable to read the catalogue, it doesn't know where the programs are situated on the floppy, so it gives up with one of those 'DISC ERROR XX' messages. The listing enables you to read any of the valid sectors on the floppy into memory, from where the programs can easily be reconstituted, especially if you use one of the commercial toolkit ROMs.

An alternative, which often proves easier, is to store your own dummy catalogue on to track 0, sector 0. This may allow the DOS to read the floppy in the normal way, and once it has been established what the real file-names are, the catalogue can be reformed correctly and stored back on the floppy. This method naturally requires a detailed knowledge of the format of the catalogue, and this is given in table 1 overleaf.

For the adventurous, table 2 gives some of the more useful DOS routines

```

5P.#12
6DIMR10,Q10
7IN,"READ OR WRITE"#$R
8IF#$R="WRITE";GOTO 10
9#$R="READ"
10P,"#$R"
15IN,"TRACK"#$A;IFA>39 G.15
17?#80=A
20IN,"SECTOR"#$A;IFA>9 G.20
25?#81=A
30IN,"BLOCKS"#$A;IFA?#81>10;G.30
32?#82=A
35#Q="?#84=#"
40IN,"START PAGE"#$Q+6;IFLENQ>8;G.40
50?#83=255;EXEC#Q;?#84=?#84-1
110DIM LL5
112LL2=#8200
113P.#21
115FORX=0T01
117P=#8200
120CJSR #E77A
130BNE LL1
140JSR #E75B
150JSR LL2;]
160IF#$R="WRITE";C:LL0 JSR #E796;]
161IF#$R="READ";C:LL0 JSR #E792;]
162CLDA #83;STA #F6
163LDA #84;STA #F7;]
170IF#$R="READ";CLDA @#53;]
172IF#$R="WRITE";CLDA @#48;]
180CJSR #E7E0
190JSR #E7A4
200BNE LL0
210:LL1 RTS
220:LL2 LDA #80
230STA #EC
240LDA #81
250STA #ED
260LDA #82
270STA #F1
280JMP #E709
420]
430N.
435P.#6;P=#8200;LINKP
440END
    
```

Listing 2. David Lake's data recovery utility

#2000-#2007	First eight ASCII characters of title.
#2008-#20FF	Names and qualifiers of files. This area is split into 31 blocks of eight bytes, corresponding to each file. The first seven bytes give the filename, the eighth gives the ASCII qualifier. Bit 7 of the qualifier is set if the file is locked.
#2100-#2104	Last five ASCII characters of title.
#2105	Extent of table. #2000 + ?#2105 is the start of the last filename in the catalogue. #2100 + ?#2105 is the start of the data for the last file (see below).
#2106	Unknown.
#2107	Unknown.
#2108-#21FF	This area is again split into 31 blocks of eight bytes, each block corresponding to the filename in the same place in the table above. The format is: 1st 2 bytes, start address 2nd 2 bytes, execution address 3rd 2 bytes, length 4th 2 bytes, start sector.

**Table 1. Catalogue format**

which access the INTEL 8271 floppy disc controller. This device is memory-mapped to #0A00-#0A04, and data is transferred under non-maskable interrupt. The floppies are formatted into 40 tracks of 10 sectors, each containing 256 bytes. Listing 2 could be adapted for use in other programs, to make best use of the storage space on the floppy. In particular, the Forth system could be modified to access sectors individually, giving up to 200 screens per floppy, instead of the meagre 31 in the standard system.

#CD	*SET qualifier
#AC	*USE qualifier
#EE	Drive number & status flags
#EC	track number
#ED	sector number
#F1	#20 + number of sectors to read
#F0	number of attempts to read/write before giving up
#F6-#F7	address of start of data

**Table 3. Page zero locations**

#E000	Reset FDC and initialise its parameters.
#E016	Print the message following the subroutine call (terminated with a negative byte).
#E231	Load catalogue buffer (*DIR).
#E237	Load catalogue, decode and display.
#E3E5	New command line interpreter.
#E6FF	Load vectors and prepare to access first two sectors on disc (catalogue).
#E729	Read result register of FDC.
#E75B	Load head.
#E792	Boot block of code for read or write to #00F2-#00FC.
#E7A4	Act on result of operation.
#E7D2	Send command in acc to FDC.
#E7E4	Wait for end of operation.
#E809	Send parameter in acc to FDC.
#E84F	Read data bootstrap code.
#E85A	Write data bootstrap code.
#E87B	NMI service routine.
#EEE2	Setup vectors.

**Table 2. DOS routines**

◀ page 121

*Creative Graphics on the BBC Micro.* Breaking it down, line 20 sets up a hi-res screen, line 50 starts an outer loop (which is never jumped out of) and line 60 begins the main loop. Line 70 sets up H% to a constantly reducing value – the reason for this will become clear later. Line 80 calls the cube drawing routine, passing over values for X%, Y%, S% and C%. Line 90 terminates the main loop and line 100 effectively re-runs the program. The cube drawing routine follows, and line 130 calculates the position of the rear cube face, while line 140 sets the cursor origin to X%, Y%. Line 150 selects the drawing colour for the front face, which is then drawn by doing two filled triangles. Line 200 changes the colour palette again, before finishing off by drawing the rear face and the connecting lines.

This program draws a series of progressively larger cubes from the back (top) of the screen to the front (bottom). Hidden line removal is taken care of by 'pasting over' new cubes on top.

Now for the variables. H% constantly reduces in value, ensuring that later drawings start lower down the screen. S% uses H% in inverse proportion, to give a cube size (edge) which is constantly increasing. E% and D% use S%

to calculate the position of the rear cube face (so that all the cubes are drawn from the same viewpoint) and X% and Y% determine where the cube's screen position is. The remaining variable, C%, determines the colour of the cube face.

Listing 2 shows the resulting program after conversion to AtomBasic. This is of course in black-and-white, so line 40 of the original program has been ignored, and the REPEAT . . . UNTIL loop has been changed to a straight re-run. Variable signs have been preserved, with the exception of X%, which now becomes P.

Since plotting filled triangles involves a lot of coding, I have changed

the cube drawing routine (subroutine c) so that it draws a filled square. There is no colour, but lines 150 and 160 determine whether to draw in white or black, thus achieving the 'pasting over' effect. Apart from the addition of some variables for intermediate calculation, the only other change is the calculation in lines 50-70 for the parameters to pass over to the subroutine.

I hope that this short series has shown Atom users that they have a passport to the pages of *Acorn User* that lie outside the Atom section. I cannot go into every aspect of other Basics, but practice makes perfect, so try your hand at conversion and open up new horizons on your programming.

5REM: Cubes	120C=D=S/3;E=S+Z	250PLOT6,Z,(Y-D)
6REM: TRANSLATED BY	130F=D+Z;G=E+D	260PLOT6,Z,(Q-D)
7REM: B. PICKLES	140Q=Y-S	270MOVE E,(Y-D)
10CLEAR4	150IFC=0 M=7;G.D	280PLOT6,E,(Q-D)
20F.Y=1TO192 S.4	160M=5	290IFM=5 R.
30 O=Y	170BF.P=Z TO G	300MOVE Z,(Q-D)
40 H=190-A.R.*Y	180 MOVE P,Y	310PLOT6,E,(Q-D)
50 Z=A.R.*255;Y-H	190 PLOT M,P,O	320PLOT6,G,Q
60 S=(190-H)/4	200 Y=Y*(P/F)	330PLOT6,G,Y
70 C=A.R.*2;GOS.C	210 Q=Q+(P/E)	340PLOT6,F,Y
80 Y=O	220N.	350PLOT6,Z,(Y-D)
90N.	230MOVE G,Y	360R.
100LI.FFFE3;RUN	240PLOT6,E,(Y-D)	

**Listing 2. The cubes program converted to AtomBasic**



Put an end to inefficient, slow cassette tape storage



# Speed your data access with a TEAC disk drive from Viglen

**NEWS FLASH**  
Inquire about the Viglen ROM Cartridge system. Only £19.95 incl. VAT.



**SWITCH 40 80** Track switch on rear panel

Replacing your cassette with a disk drive means Data Access in less than 5 seconds! If you are looking for a guaranteed disk drive that's fully compatible, at a price that includes VAT, Formatting Disk, User Manual, Case and Leads, then just look at our all-inclusive prices!

When ordering Dual Drives, please state which layout you prefer. A or B.

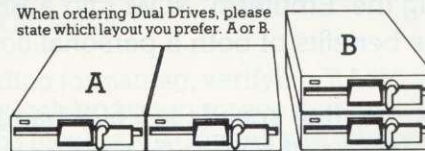

TEAC 55 Slimline Drives		Incl. VAT	Excl. VAT	DUAL DRIVES CASED	Incl. VAT	Excl. VAT
<b>SINGLE DRIVES CASED</b>				40 TRACK 200K	£287.50	£249.57
40 TRACK 100K	£143.75	£125.00	40/80 TRACK SWITCHABLE 400K	£358.00	£311.30	
40 TRACK 200K	£195.00	£169.56	40/80 TRACK SWITCHABLE 800K	£450.00	£391.30	
40/80 TRACK SWITCHABLE 200K	£179.00	£155.65	DFS KIT	POA	POA	
40/80 TRACK SWITCHABLE 400K	£225.00	£195.65	Disc Filing System 100% Acorn Compatible			
			Integral Power Supply	£30.00	£26.09	

All prices correct at time of going to press and all offers subject to availability.

- These drives are fully compatible with other computers and can be still used should you change your computer for another type.
- Orders welcomed from Educational Establishments and Government Departments.

### TEC DRIVES (As used by Cumana)

	Incl. VAT	Excl. VAT
40 TRACK 100K	£129.00	£112.17
40/80 TRACK 200K	£169.00	£146.95
40/80 TRACK 400K	£209.00	£181.74
For Dual TEC drives the price is double the single drive price.		
Integral Power Supply	£30.00	£26.00

### How to order

**By post:** To purchase any of the items simply fill in the coupon with your requirements. Enclose your Cheque/P.O. or use your Access/Barclaycard. Please make cheques payable to: VIGLEN COMPUTER SUPPLIES and post to above address. Allow seven days for delivery and add £8.00 carriage, package and insurance on all items.

**By telephone:** Ring (01) 843 9903. Credit Card holders (Access/Barclaycard only) can purchase by telephone. Please give Card No., Name, Address and the items required.

# Viglen

COMPUTER SUPPLIES

Unit 7 Trumplers Way  
Hanwell W7 2QA  
Tel: (01) 843 9903

Post to: VIGLEN COMPUTER SUPPLIES UNIT 7, TRUMPERS WAY, HANWELL, W7 2QA

Please send me the following items:

I enclose Cheque/P.O. for £ \_\_\_\_\_

I prefer to pay by ACCESS/BARCLAYCARD\* Card No: \_\_\_\_\_

Signature \_\_\_\_\_

Name \_\_\_\_\_

Address \_\_\_\_\_

Add £8 carriage. \*Delete as necessary

Layout A or B\*

AV7/11

**Full Twelve Months Guarantee**

# Draw with the BBC micro and show the true potential of your machine

Fill shapes in one of 23 colours (Mode I)  
 Draw points, lines, rectangles ellipses and circles  
 Smooth curves  
 Wire frame diagrams  
 Hidden line removal  
 Draw in perspective  
 Measure scaled distances  
 Ekta sketch lines, Half tone facility  
 Mirror images  
 Repeat images, SS, enlarged, reduced, stretched  
 Actual colour displayed  
 Store up to 10 ellipses or circles in memory  
 Redraw any one of these at cursor position  
 Change any actual colour for one of 8 others  
 Clear screen, load screen, save screen  
 Print characters or numbers at any pixel point  
 Error messages for incorrect input  
 Fully comprehensive manual

35¢ 496 \* □ \*\*\* 3

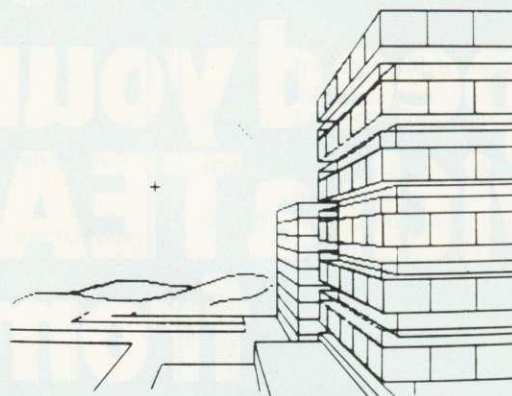

This programme has been purpose designed by professional Graphic Designers for simplicity and ease of use, and is undoubtedly the most versatile drawing programme on the market at this time. There is no need to input any numerical data, as all judgements are made visually. The BBC Micro is the finest drawing machine in its price range. Find out what it can do.

The A.B. Designs drawing programme costs only £35 for over 70 functions (Model B). New AB2 Program, available on disc (price £60.50) and cassette (price £50.50). When ordering send Cheque/PO and include 50p for P&P. Please include phone no. with all correspondence. For further information send SAE and phone no. to A.B. Designs, 81 Sutton Common Road, Sutton, Surrey. 01-644 6643 (closed all day Thursday).

## VT100 Intelligent Workstation

Plug the 'Emuterm' ROM into a BBC Microcomputer (Model B) to give the benefits of both a personal computer and a DEC VT100 terminal.

- ★ line speeds to 9600 baud, 3 or 5 wire operation
- ★ almost all VT100 features supported including VT52 mode
- ★ switch between terminal mode and native microcomputer by simple command
- ★ fitted in a few minutes by following the simple instructions
  - ★ optional intelligent file transfer mode
  - ★ optional numeric keypad (automatically used if fitted)

**VT100 Emuterm ..... £35 inc p&p and VAT**

Other terminal emulators (inc Newbury 7000 and 8000 series) and communication software available. Please send sae for details.



All orders and enquiries to:

**Applied Real Time Systems Ltd.,  
 Dept AU, PO Box 32, Sunderland, SR2 7SN.**

DEC, VT100 and VT52 are registered trademarks of Digital Equipment Corp., Maynard.

# SPECIAL OFFER From Viglen

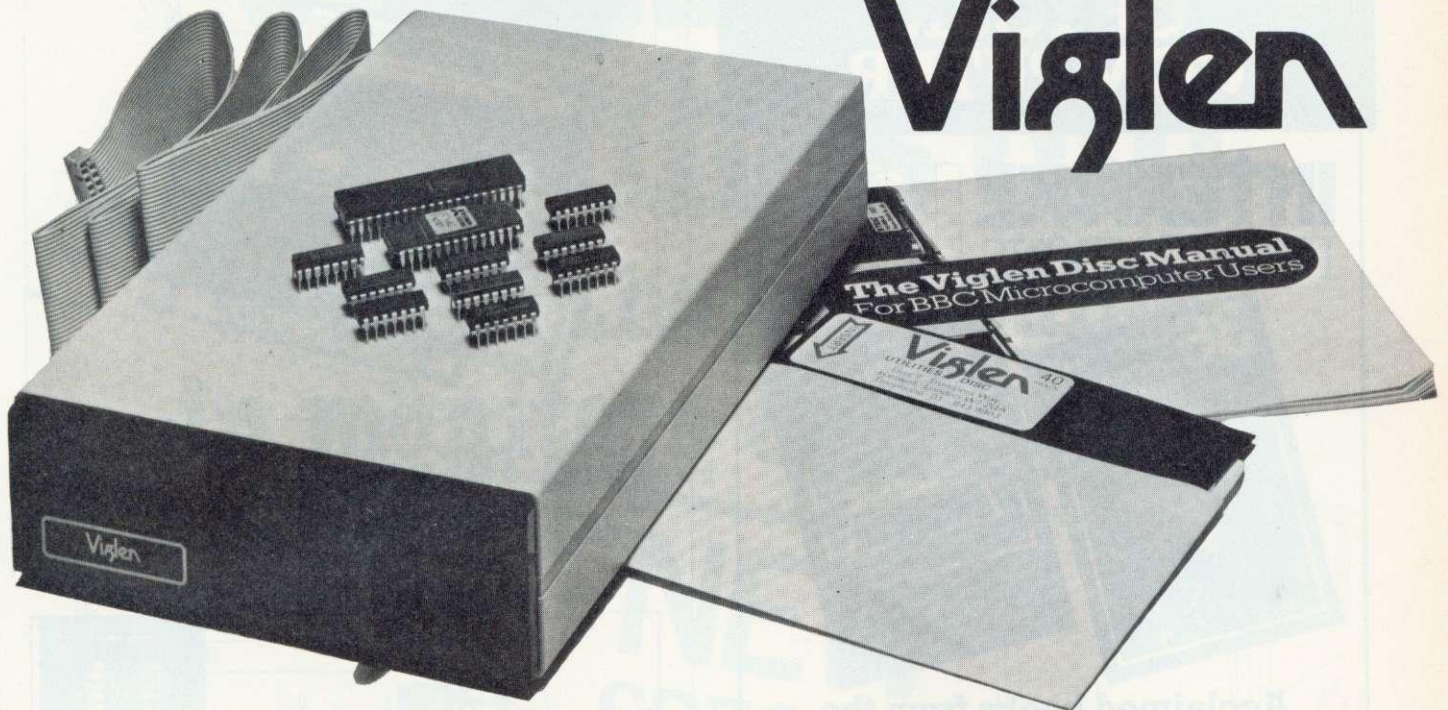

## THE TEC DISK DRIVE (AS USED BY CUMANA)

### COMPLETE DISK SYSTEM FOR THE BBC MODEL B

• Package assumes you own a BBC Model B with switched mode power supply plus 1.2 operating system.

#### OFFER INCLUDES:

- Disk Interface (call at factory for free fitting)
- 200K 40/80 track single sided TEC FB502 Slimline Disk Drive including case and all leads
- User Guide
- Utilities Disk including formatting, verifying, BASIC program comparator, disassembler, Epson screen dump, dual catalogue (giving 62 files), large printing and others

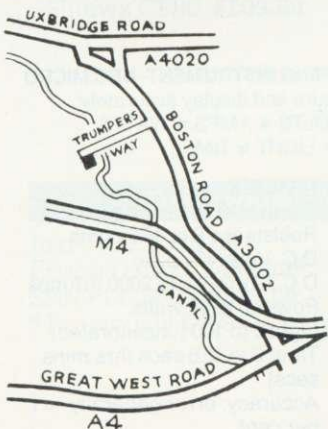

**DISK DRIVE AND INTERFACE**  
**£269**  
INC. VAT

**Viglen**  
COMPUTER SUPPLIES

Unit 7 Trumpers Way  
Hanwell W7 2QA  
Telephone: (01) 843 9903

Prices correct at time of going to press - offer subject to availability.

Post to: VIGLEN COMPUTER SUPPLIES UNIT 7, TRUMPERS WAY, HANWELL, W7 2QA

Please send me \_\_\_\_\_ (Qty) TEC 200K + DFS

I enclose Cheque/P.O. for £ \_\_\_\_\_ made out to VIGLEN COMPUTER SUPPLIES (please add £8 for carriage)



I prefer to pay ACCESS/BARCLAYCARD Card No. \_\_\_\_\_

(Delete whichever not applicable)

Signature \_\_\_\_\_

Name \_\_\_\_\_

Address \_\_\_\_\_



  
Check card to make sure it is valid  
if card holder not in the name  
above mail to the bank

AUS/2

# MAKE THE MOST OF YOUR COMPUTER.

**INTERFACE PUBLICATIONS** 



## Acclaimed books from the experts . . .

- Dynamic Games for your Electron  
Neal Cavalier-Smith. £4.95
- 36 Challenging Games for the BBC Micro  
Chris Callender and Tim Rogers. £5.95
- Let Your BBC Micro Teach You to Program  
Tim Hartnell. £6.45
- Putting Your BBC Micro to Work (includes a full  
word-processing program, plus 14 others)  
Chris Callender. £4.95
- Creating Adventure Programs on your Computer  
Andrew Nelson. £4.95
- The Easy Way to Program Your New Computer  
Tim Hartnell. £3.95
- Practical Applications for the Microcomputer  
in the Home.  
David Hole. £4.95
- The Art of Structured Programming  
Peter Juliff. £5.95

These books are available from most book and computer stores. In case of difficulty, order directly from us.

**Interface Publications, Dept. QAU,  
9-11 Kensington High Street, London W8 5NP.**

Please send me the indicated books. I enclose £ \_\_\_\_\_

Name \_\_\_\_\_

Address \_\_\_\_\_

**INTERFACE PUBLICATIONS** 

**We're the Experts.**

(TRADE ONLY: Interface Publications are distributed exclusively in the UK and  
Eire by W H S Distributors. Export trade handled by Interface Publications.)

# THE EPSON PX-8.



## AVAILABLE NOW

Pulse/Heart monitoring unit for PX-8 & BBC with full supporting software & printout facility. **Only £99.00 inc. VAT.**

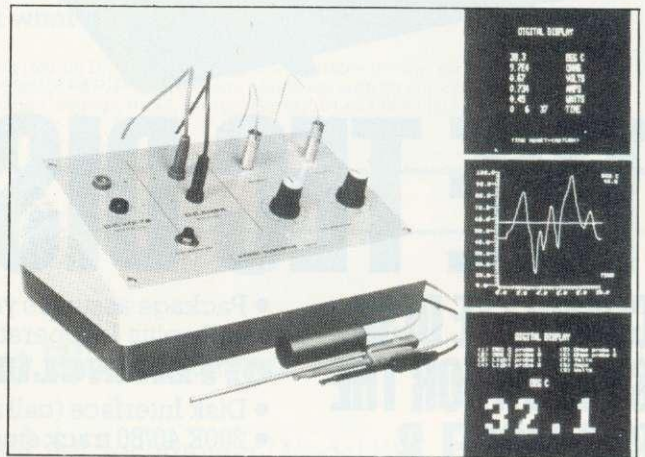

## Excet EMU3

**SOFTWARE SUPPORTED MONITORING INSTRUMENT—BBC MICRO**

Enables the BBC (B) to measure and display accurately:  
POSITIVE & NEGATIVE—VOLTS ★ AMPS ★ WATTS  
OHMS ★ TEMP ★ LIGHT ★ TIME

### FEATURES

Up to 6 simultaneous readings  
Graphical or digital display  
Auto scaling and labelling  
Plots any 2 variables  
Menu driven options  
Full software support  
Unlimited choice of scales  
Event analysis facility  
Teaching display mode  
£129.00 plus VAT

### RANGES

Temp - 10 to 110 deg C  
Resistance 0 to 1E6 ohms  
D.C. Volts 40v.p.d.  
D.C. Current 0 to 2000 mAmps  
Power 0 to 80 watts  
Light 0 to 100 (uncalibrated)  
Time 0 to 1E6 secs (hrs mins secs)  
Accuracy: error generally < 1 per cent

Includes instrument, temperature probe, light sensor, electrical probes (3 sets), leads, connections, software on cassette, full instructions, application notes, p&p

**BITS & BYTES  
(COMPUTERS) LTD.**

20/21 South Street, South Molton  
Devon EX36 4AA. Telephone 07695 4141

# VIGLEN

## branches out

### to offer the best value in monitors & printers

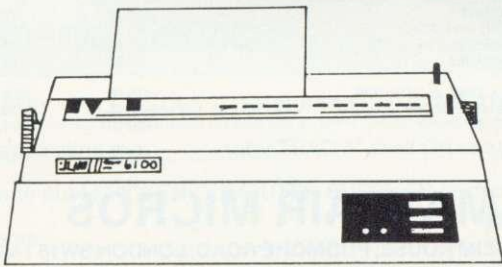

**NEW  
SPECIAL  
OFFERS**

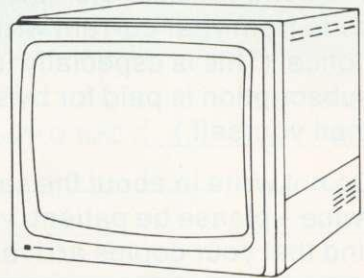

#### Dot Matrix Printers

Epson RX80/FT **£275.00**  
 Epson FX80 **£379.00**  
 Canon PW 1080 A **£289.00**  
 160 cps with near letter quality printing  
 including friction and tractor feed.  
 Shinwa CP80 **£209.00**

#### Colour Monitors

Microvitec standard 1431 **£199.95**  
 Microvitec medium 1451 **£315.00**  
 Microvitec high 1441 **£442.00**  
 Philips 14" TV/monitor **£235.00**  
 (RGB Input)

#### Daisywheel Printers

Juki 6100 **£375.00**  
 Epson DX100 **£450.00\***  
 SAN PLE 2000 **£299.00**  
 \*Previously £499.00 Limited Stock

#### Monochrome Monitors

Philips 12" Green V2001 **£75.00**

ALL prices include VAT and leads for the BBC model B micro.  
 Please add £8 for carriage.  
 We also stock other computer peripherals, accessories and  
 complete work processor systems at unbelievable prices.  
 Please call for our latest offers.  
 You may also purchase these items direct by calling at  
 our factory/showroom in Hanwell, London.  
 Prices correct at time of going to press and offers  
 subject to availability.

Post to: VIGLEN COMPUTER SUPPLIES UNIT 7, TRUMPERS WAY, HANWELL W7 2QA

Telephone: 01-843 9903. Personal Callers Welcome.

Please send me (state number required)

I enclose Cheque/PO. for £

I prefer to pay ACCESS/BARCLAYCARD (Delete whichever is not applicable)

Card No. \_\_\_\_\_

Signature \_\_\_\_\_

Name \_\_\_\_\_

Address \_\_\_\_\_

Incl. £8 carriage. Cheques payable to Viglen Computer Supplies.  
 Credit cards valid if signed by  
 card holder. Address below must  
 be the same as card holder.

AV7/2

# ACORN USER SUBSCRIPTIONS

We apologise to readers who have suffered a disruption following the change of publisher.

All records have now been transferred to a new computer system, but there is still a backlog of renewals and queries from people quoting the old subscriber numbers.

A 24-hour answering service on all subscription enquiries is available on Nutfield Ridge (073782) 2957.

Correspondence will be dealt with faster if you send or quote the new Redwood 7-digit code from your current wrapper or renewal notice. (This is especially important if the subscription is paid for by someone other than yourself.)

Do not write in about the same problem twice – please be patient, you should still find that your copies arrive.

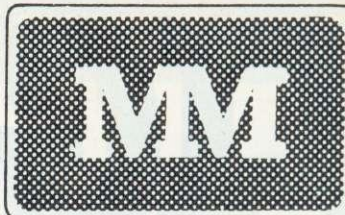

## TOP SAVINGS

PRINTERS	EX VAT	INC VAT
BROTHER HR 15	340.00	391.00
TRACTOR	62.00	71.30
SHEETFEEDER	185.00	212.75
KEYBOARD	135.00	155.25
EPSON RX80T	199.00	228.85
EPSON RX80F/T	225.00	258.75
EPSON FX80P/T	324.00	372.60
EPSON RX100F/T	350.00	402.50
EPSON FX100F/T	430.00	494.50
FX80 TRACTOR	30.00	34.50
JUKI 6100	335.00	385.25
MANNESMANN TALLY MT 80	199.00	228.85
NEC 2050 (IBM PC)	725.00	833.75
OKI MICROLINE 82A	255.00	293.25
OKI MICROLINE 83A	395.00	454.25
OKI MICROLINE 92P	379.00	435.85
SEIKOSHA GP 100A	165.00	189.75
SHINWA CP80	175.00	201.25
STAR GEMINI 10X	199.00	228.85
STAR DELTA 10	329.00	378.35
<b>COMPUTERS</b>		
COMMODORE 64	152.17	174.99
COMMODORE 1541 DISK	165.21	189.99
COMMODORE C2N CASSETTE	36.51	41.99
INTFACE 64-PAREL	59.50	68.43
APRICOT 2 x DISK + MONITOR	1475.00	1696.25
APRICOT 10 MB + MONITOR	2395.00	2754.25
SANYO MBC555	850.00	977.50
EPSON QX10	1600.00	1840.00

## MAYFAIR MICROS

BLENHEIM HOUSE, PODMORE ROAD, LONDON SW18 1AJ  
01-870 3255

# PHILIPS 14" COLOUR TV/MONITOR

£235 inc VAT

TV/Monitor (resolution better than 585 x 450 pixels. Dot-to-dot distance .65mm)

(TV only: £185 inc VAT)

Plus £8 carriage and packing

**Viglen**  
COMPUTER SUPPLIES

Personal Service & Quality coupled with Wholesale Prices, Unit 7 Trumpers Way, Hanwell, London W7 2QA. Telephone: 01-843 9903.

For special attention to your orders or enquiries concerning MONITORS, PRINTERS, COMPUTERS, DISC DRIVES, ring VERONICA, SYLVANA or CATHY on 01-843 9903 NOW or fill in the coupon below.

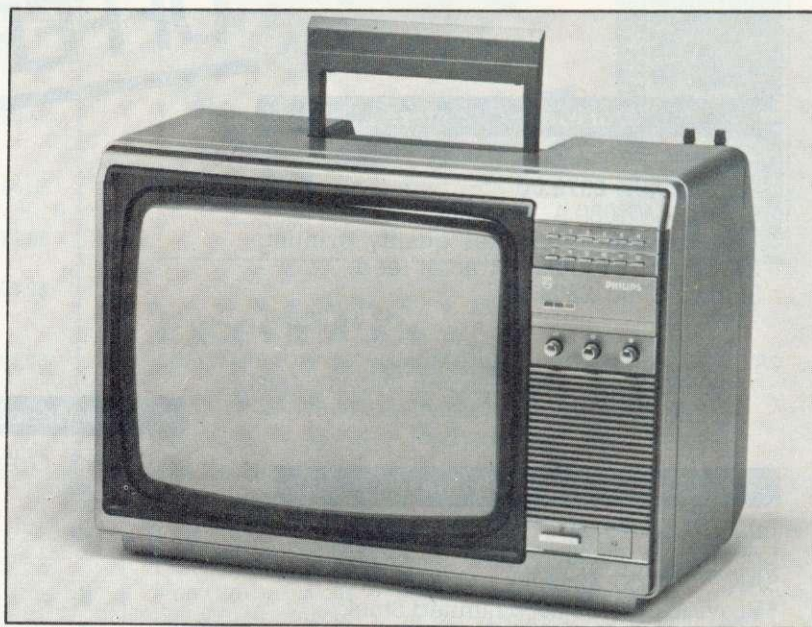



- Easy to carry • Lightweight • Sparkling picture in seconds • Reliability and performance excellent • Headphone Socket can also be connected to tape recorder • Loudspeaker mute switch • Retractable carrying handle
- Metallic silver finish with restful dark picture surround • Includes RGB lead connecting direct to your BBC Micro. • Philips Model No. 14CT 2006/05T

Post to: VIGLEN COMPUTER SUPPLIES, UNIT 7, TRUMPERS WAY, HANWELL, LONDON W7 2QA.

Please send me \_\_\_\_\_ (qty) Philips TV/Monitor at £243 each. I enclose Cheque/P.O. for £ \_\_\_\_\_ made out to

VIGLEN COMPUTER SUPPLIES or debit my ACCESS/BARCLAYCARD No. \_\_\_\_\_

Name \_\_\_\_\_   Signature \_\_\_\_\_

Address \_\_\_\_\_

# INTRODUCING THE TEAC 3" DISC DRIVE

Single 100K £159 inc VAT + £8 carriage

Cased, and price includes cables, utilities disc and manual.

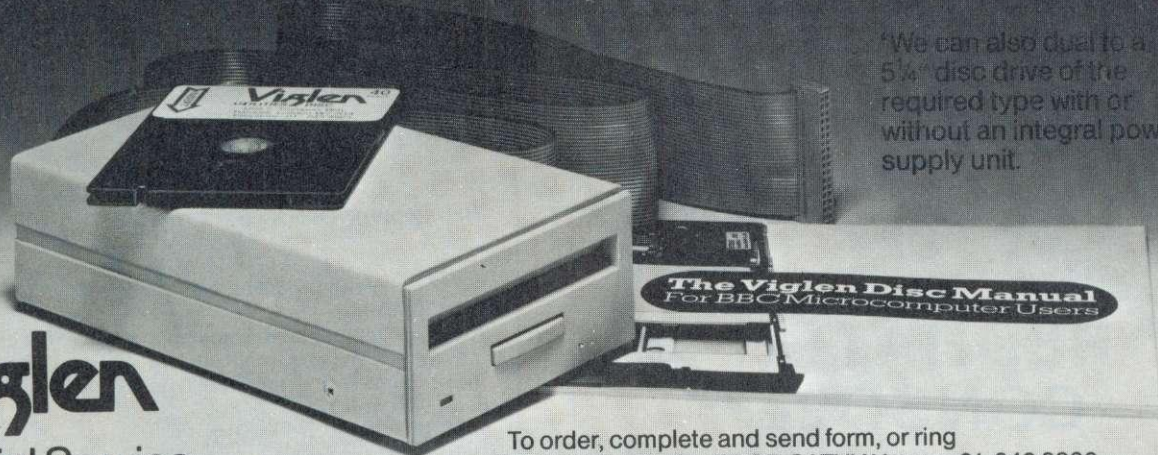

\*We can also dual to a 5 1/4" disc drive of the required type with or without an integral power supply unit.

The  
**Viglen**  
Special Service

To order, complete and send form, or ring  
VERONICA, CAROLINE OR CATHY Now on 01-843 9903

AU7/4

Post to: VIGLEN COMPUTER SUPPLIES, UNIT 7, TRUMPERS WAY, HANWELL, LONDON W7 2QA.

All prices correct at time of going to press and all offers subject to availability.

Please send me \_\_\_\_\_ (qty) TEAC 3" Disc Drive at £159 each + £8 carriage. I enclose Cheque/P.O. for £ \_\_\_\_\_

made out to VIGLEN COMPUTER SUPPLIES or debit my ACCESS/BARCLAYCARD No. \_\_\_\_\_

Name \_\_\_\_\_  Signature \_\_\_\_\_

Address \_\_\_\_\_

## NEW!

from

# Viglen

COMPUTER SUPPLIES

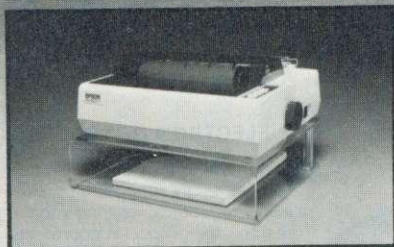

Printer Stand

**£12.95** INC. VAT

Carriage & Packing £2.00

## A PRINTER STAND

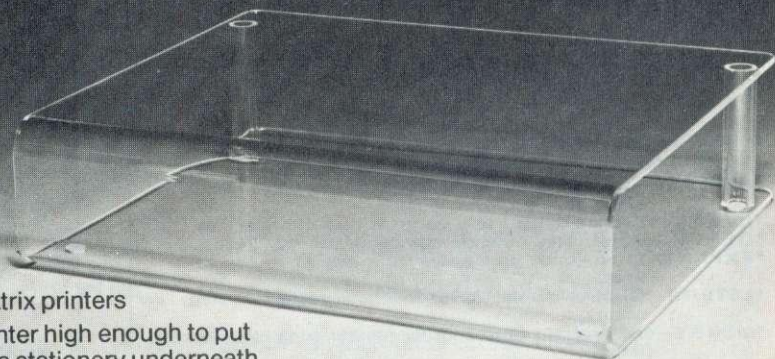

- For dot matrix printers
- Raises printer high enough to put continuous stationery underneath
- Beautifully finished in clear perspex • Viglen quality every time
- Will accept paper up to 12 1/2" wide • Non slip rubber pads

Dimensions: 15" (380mm) wide 12 1/2" (320mm) deep 4" (90mm) high

### COME TO VIGLEN FOR A FAST, FRIENDLY, PERSONAL SERVICE

To order, complete and send form, or ring  
VERONICA, CAROLINE OR CATHY Now on 01-843 9903

Post to: VIGLEN COMPUTER SUPPLIES, UNIT 7, TRUMPERS WAY, HANWELL, LONDON W7 2QA.

Please send me \_\_\_\_\_ (qty) PRINTER STANDS at £14.95 each. I enclose Cheque/P.O. for £ \_\_\_\_\_ made out to

VIGLEN COMPUTER SUPPLIES or debit my ACCESS/BARCLAYCARD No. \_\_\_\_\_

Name \_\_\_\_\_  Signature \_\_\_\_\_

Address \_\_\_\_\_

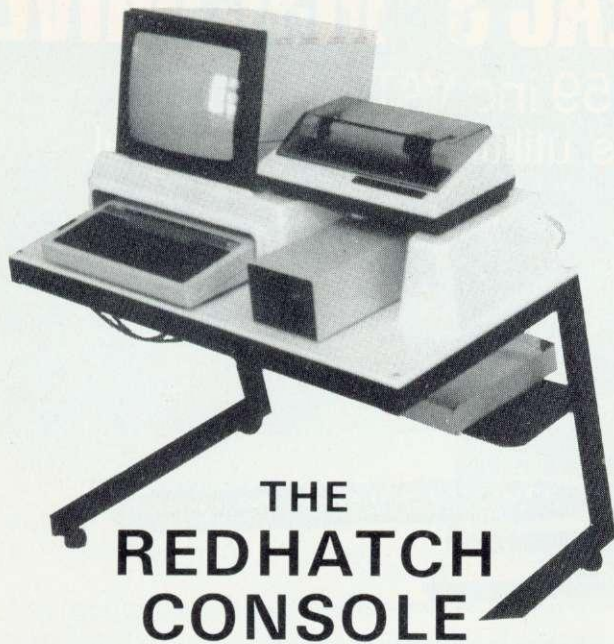

## THE REDHATCH CONSOLE

The engineered accommodation for micro and peripherals for home educational and industrial environment. Basic unit complete with power plug and cable, 4-way socket, central switch, Post Packing and VAT

**£54.36**

Write or ring for details.

**REDHATCH LTD., WAKERLEY STATION,  
OAKHAM, LEICS. (Morcott 549).**

## Intersoft

### Utility Toolkit in ROM for the BBC Micro

#### A BRIEF SPECIFICATION

- \*FIND—find any string or keyword in a Basic program
- \*REPLACE—any string or expression with another of any length
- \*LVAR—list variables used in a program in decimal or hex.
- \*DEREM—one of three program compacters in the toolkit.
- \*EXPAND 11,nn—open up a space from line 11 to add nn lines.
- \*LSTERR—select or deselect error line listing when an error occurs.
- \*MERGE—one program onto another, renumbering to prevent clashes.
- \*REPAIR—sort out a 'Bad program' and list suspect lines.
- \*SHIFT—relocate a Basic program up or down to any valid page.
- \*KEYS—list the contents of any defined keys.
- \*MEMLOCS—display all the current program pointers and sizes

Plus eleven more useful utilities for program development and debugging. Where else can you buy so many utilities at this price?

ALL VERSIONS NEED OS 1.20 AND BASIC 1 or BASIC II (please State which)

£25.50 (Inclusive of VAT and Postage)

Send Cheque / P.O. to INTERSOFT,

26 Netherfield Road, Sandiacre, Nottingham.  
NG10 5LN

### DISC DRIVE OWNERS!

Still playing games?  
Realise the potential of your DISC DRIVES  
Learn to handle  
RANDOM ACCESS FILES  
and start creating for yourself

AN  
INTRODUCTION TO  
RANDOM ACCESS FILING  
ON THE  
BBC MICRO

This 101 page publication is available NOW and is supplied complete with DEMONSTRATION DISC (40 track) containing an example STOCK CONTROL system and a PERSONNEL system.

Price £12.50 complete  
MISSING — PRESUMED LOST...

Your favourite program is deleted from your disc by accident —  
But WAIT!  
UTILITIES 1 is the answer —  
two programs designed to help you.

#### 1. DISCMAP

A unique 'picture' of the contents of your disc helps you to spot where 'missing' programs are waiting to be recovered. Incorporates full details of all catalogued programs and a PRINTER option.

#### 2. DELETED FILE RECOVERY

Helps you recover ALL or PART of a deleted BASIC program or Machine Code program. INVALUABLE for recovering data from discs with corrupted catalogues. Incorporating a SECTOR SEARCH which will display sector contents in a uniquely readable way!

Supplied on disc (40 track)

£8.95 complete with FULL DOCUMENTATION  
THE COMPUTER ROOM  
206 MAIN STREET  
NEWTORPE, NOTTS.

### EXPANDABLE CONSOLE FOR BBC MICRO

As supplied to Universities, Colleges, Schools,  
business & home users

A professional console to house disc drives/2nd processor/Torch dual drives/teletext, etc. All untidy wiring out of sight in the strong aluminium console in a matching textured colour. AVAILABLE NOW a bolt on extra module for extra expansions.

Also available a matching printer stand, yes stack your paper under the printer.

ALSO VDU STANDS AVAILABLE

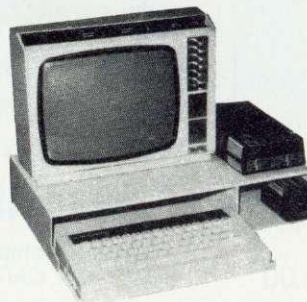

#### ELECTRON CONSOLES

The console houses the electron and will safely support the expansion interfaces which plug into the rear of the micro, supports the VDU and tidies up all wiring, allows expansion to disc at a later date.

#### PRICES

Special Torch Version £46.99 + £4 p/p  
BBC Console £44.99 + £4 p/p  
Bolt on expansion £14.99 + £2 p/p  
VDU/Printer Stand £14.99 + £2 p/p  
Electron Console £34.99 + £4 p/p

Please add VAT @ 15% to all prices

For further information enclose sae or send cheque to,

Mail Order  
Only

**Silent** 01-801 3014  
**COMPUTERS**

27 Wycombe Rd  
London N17

Viewing by  
arrangement

24 hour  
ansaphone

Please allow 28 days for delivery



# British Disc Drives direct from the manufacturer



- BBC compatible ● Metal case
- Dual drive ● Switchable 40/80 track
- Complete with utilities disc – manual and cables
- The only 5 1/4 in. drive designed and manufactured in Britain

5 1/4 single sided dual unit 400K **£279**  
5 1/4 double sided dual unit 800K **£349**  
For box with power supply add **£30**  
Carriage **£8**

Access & Barclaycard accepted  
Prices exclude V.A.T.

Data Track Technology  
The U.K. source for 5 1/4 in. disc drives



Data Track Technology Limited,  
7 Queensway, Stem Lane Industrial Estate,  
New Milton, Hampshire, U.K., BH25 5NN  
Tel: (0425) 619650 Telex: 47674

# ELBUG FOR THE ACORN ELECTRON

JOIN NOW  
FOR A  
FREE  
CASSETTE

## Join the Electron User Group

Members receive 10 copies of the magazine **ELBUG** each year. **ELBUG** is devoted **EXCLUSIVELY** to the **ELECTRON MICRO**. It is packed with News, Reviews, Hints, Tips, Programming ideas, Major articles, plus Regular program features including games and useful utilities.

**ELBUG** is produced by **BEEBUG** Publications Ltd., publishers of **BEEBUG**, the magazine of the National User Group for the BBC Micro. **BEEBUG** now has some 20,000 members and has achieved a high reputation both in this country and abroad.

The formula which makes **BEEBUG** an invaluable companion for users of the BBC micro, has been applied to **ELBUG**.

By subscribing to **ELBUG** you gain all the advantages of a single-micro magazine, with

no space wasted on programs and articles for other computers.

### BENEFITS OF MEMBERSHIP

#### ELBUG MAGAZINE

Ten copies a year mailed free of charge.

#### DISCOUNT SCHEME

Extensive discount scheme with major retailers.

#### SOFTWARE LIBRARY

A growing range of software titles at budget prices for members.

#### SOFTWARE CLUB

Substantial discounts on software from major software houses.

#### LOCAL USER GROUPS

Lists of local affiliated user groups.

## SPECIAL OFFER 8 FREE PROGRAMS

*Subscribe now, and get a free introductory cassette containing 8 tested programs for the Electron.*

1. **SPACE CITY**. Defeat the invading Aliens with your laser, and save the city
2. **3D NOUGHTS AND CROSSES**. Pit your wits against the **ELECTRON** on a 4x4x4 board
3. **RACER**. Guide your racing car to victory, avoiding other cars and obstacles on the track
4. **3D MAZE**. In this challenging game, you must escape from the maze - The screen displays a 3D view from inside the maze
5. **PATCHWORK**. A multicoloured display of continuously changing patterns
6. **KEY SET ROUTINE**. A program to set up the user function keys
7. **MEMORY DISPLAY**. An efficiently written utility to display the contents of memory (ROM and RAM)
8. **CHARACTER DEFINER**. Define individual graphics characters with this useful utility for use in your own programs.



SPACE  
CITY

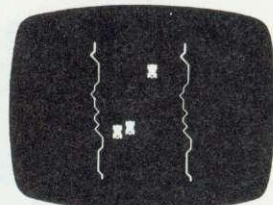

RACER

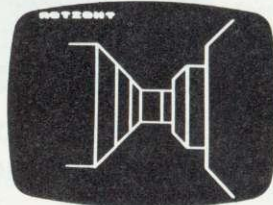

3D MAZE

### HOW TO JOIN

To subscribe for one year, and get your FREE CASSETTE send £9.90 (payable to Orbit) plus a strong stamped addressed envelope (for the cassette)

**SUBSCRIPTIONS TO: ELBUG, DEPT 13, PO BOX 109, HIGH WYCOMBE, BUCKS**

Six months trial subscription (5 issues) UK only £5.90—FREE CASSETTE OFFER STILL STANDS.  
Membership outside UK (one year only): Eire and Europe £16.00. Middle East £19.00. Americas and Africa £21.00, other countries £23.00.  
Editorial Address: ORBIT, PO BOX 50, St Albans, Herts.

# THE ADE : UPGRADE

System's assembler/debugger/editor ROM wins praise from Vincent Fojut

**T**HE ADE ROM from System Software is a sophisticated suite of programs guaranteed to whet the appetite of any assembly language programmer. The heart of the package is a new macro-assembler, complete with library facilities. This takes ASCII source files, prepared on the comprehensive editor, and generates a file of object code, or executable machine code, which can be run and tested under the debugger. These three primary functions give the package its name—Assembler, Debugger and Editor, or ADE for short.

The system comprises a 16k ROM, a utility disc (table 1) and sizable manual. Once the ADE ROM is activated (on power-up or by typing \*ADE), the extra commands listed in table 2 are at your disposal. The three major modules are

by \*NOCTRL). Yet another way of entering the SPY utility is by using the \*FX100 command (or its machine code equivalent) from within a user program, or ADE command level.

The \*LST command calls up a 6502 disassembler, which is in fact part of the SPY utility but can be used independently. Finally, \*MODE works in the same way as the MODE command in Basic. It is included to allow an 80-column mode to be selected before an assembly. Otherwise, in a 40-column mode, the assembly listing is truncated at column 39.

To show how the elements of the system inter-relate, figure 1 (overleaf) represents a typical sequence in the development of an assembly language program. First, the editor creates (or modifies) an assembly language text

T.LIBRARY	macro librarian (source code)
LIBRARY	macro librarian (object code)
T.SYSLIB	source code for common macros
SYSLIB	library of common macros
T.DEMO	demonstration Program (source code)
D	demonstration Program (object code)
T.FMT	text formatter (source code)
T.ADV	source code used in demonstration
AD	object code run in demonstration

Table 1. ADE utility disc files

initialised by typing \*ASM, \*ED/\*EDIT or \*SPY, which invoke the assembler, editor or debugger respectively.

The remaining sundry commands are mostly intended to assist the debugging process. The \*BRK command forces the SPY debugger 'front panel' to be entered whenever a 6502 BRK instruction is encountered. This facility is deactivated with \*NOBRK. Similarly, typing \*CTRLF allows the SPY monitor to be invoked by pressing the CTRL and F keys whenever a program is awaiting user input (disabled

file (it can also be used for the preparation of documentation to accompany the program, or indeed, any general word-processing functions). Assuming, for the moment, that an assembler text file has been generated, this then becomes the source, or input file, for the assembler module.

The assembler, in turn, converts the source code into machine code and generates an output file of object code which can be directly executed. An optional assembler listing can also be produced on screen or printer at this

The ADE package can be obtained from System Software, 12 Collegiate Crescent, Sheffield S10 2BA, priced at £60 (incl VAT). An enhanced version of the SPY debugger, SPY2, is available separately, at £24.15.

stage. If errors are present, the edit and assemble phases are repeated until a 'clean' or error-free assembly is obtained. However, a lack of errors at this stage signifies only that the source code is recognised as valid by the assembler; it does not, of course, mean that there are no logic errors in your assembler program. Hence the need for a final testing and debugging phase, using the SPY monitor, to help track down and eradicate any outstanding bugs. If any bugs are present the process is repeated from the start—editing, re-assembly, and re-testing—until a bug-free, fully-tested program emerges.

The editor makes use of the mode 7 screen, which is divided by a 'status' display into an upper 'text' area and a lower 'command' area. The user may toggle between the two areas via the escape key. While entering text, in what is referred to as 'immediate' mode, the same text-manipulation functions can be achieved either by control-key combinations or by function key. For example, both f6 and ctrl-O allow you to mark a point in the text. I took the manual's advice and found the function keys to be simpler to use (only one key to hold down, as opposed to two), and the function key strip provided eliminates constant referrals to the manual.

Alternatively, text can be modified via 'deferred' commands which are entered in the command area. Deferred commands can be strung together in blocks, up to eight levels deep, any (or all) of which can be iterated a specified number of times. For instance, the sequence:

```
5<FSmith/e/=XJohnson/e/>/e//e/
```

```
*HELP ADE
ADE 1.00
ADE
ASM <sfsp> <ofsp>
BRK
CTRLF
ED (<fsp>)
EDIT (<fsp>)
FX100,<lo>,<hi>
LST
MODE <n>
NOBRK
NOCTRLF
SPY
```

Table 2. ADE command level—extra OS functions

MEMOTECH BBC CBM64 SPECTRUM ORIC1 LYNX NASCOM ATARI

**Trapped in a fiendish Level 9 Adventure?  
Your lamp burning low? Every exit guarded?**

You need escape plans! Send for one of Level 9's great new clue sheets for help. The clue sheets are free and each answers hundreds of questions: follow the instructions supplied with your adventure to get one. (Don't forget to send a stamped self-addressed envelope and tell us which game you have.)

**NEW REVIEWS:** "Level 9 are fast establishing a name for themselves among computer adventurers as the Number 1 producers of quality adventure software. All their adventures are text only, but because of a special coding they have developed, the amount of description and the number of locations packed in 32K is truly amazing."

— *Midweek, 10 May 84*

"Quicksilva call themselves the 'Game Lords'. That might be open to argument. But there can be no doubt that Pete Austin and the team at Level 9 are the 'Lords of Adventure'."

— *Central Press Features, April 84*

"Play Lords of Time and get nine times the pleasure!"

— *Your Computer, May 84*

**AVAILABLE FROM:** WH Smith and good computer shops nationwide.

If your local dealer doesn't stock Level 9 adventures yet, ask him to contact us or: Centresoft, Drake Distribution, Ferranti & Craig, Hi-Tech, Lime Tree, Microdeal, R&R or Wonderbridge.

**Level 9 Computing**

- Colossal Adventure:** the original mainframe adventure with 70 extra locations
- Adventure Quest:** an epic journey across the weird landscape of Middle Earth
- Dungeon Adventure:** a truly massive game which completes the Middle Earth Trilogy
- Snowball:** could this be the biggest SF adventure in the world?
- Lords of Time:** an imaginative romp through World History

I ENCLOSE A CHEQUE/PO FOR £9.90 EACH

My name: .....

My address: .....

My micro is a: .....  
(one of those listed on the arch above, with at least 32K of memory).

Send to:  
**LEVEL 9 COMPUTING**  
Dept. A, 229, Hughenden Road  
High Wycombe, Bucks. HP13 5PG

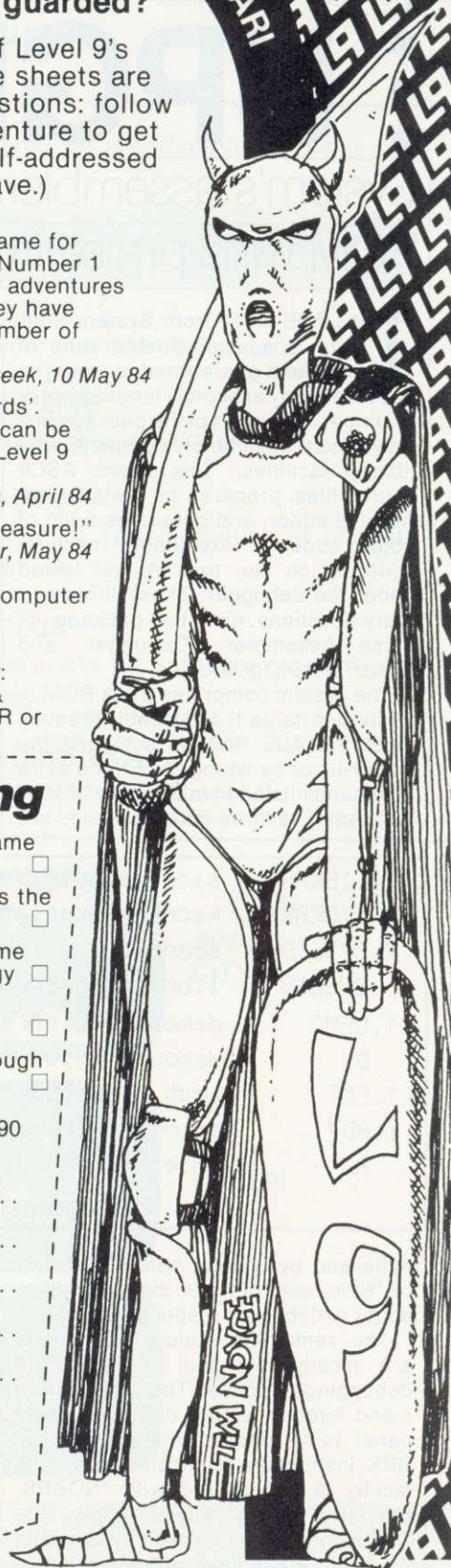
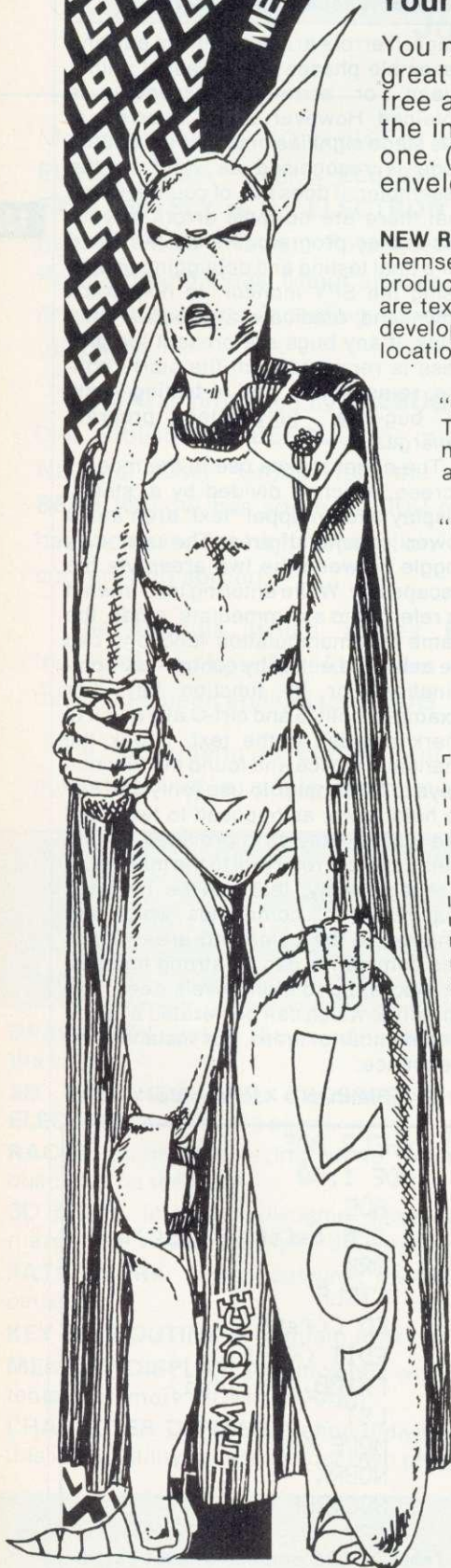

Tab	-ASCII/hex display toggle	<HEX>	-update memory at Pointer
L	-disassembly/hex display toggle	"	-enter characters into memory
M	-set up memory Pointer	P	-fill & test area of memory
Return	-increment Pointer by 1	S	-shift area of memory
+ or	-increment Pointer by 8	V	-verify (compare) 2 memory areas
/	-decrement Pointer by 1	.	-move to next register
-	-decrement Pointer by 8	<HEX>	-modify register
U	-set Pointer to value of PC	Z	-single-step
@	-set PC to value of Pointer	J	-jump to address and run Program
I	-set Pointer from memory (indirect)	K	-continue Program execution from PC
R	-set Pointer from memory (relative)	*	-O.S. command Prefix
G	-find byte Pattern	*LST	-activate disassembler
N	-find next occurrence of byte Pattern		

Table 3. SPY debugger commands

(where /e/ represents one depression of the escape key) would change five occurrences of 'Smith' to 'Johnson'. Using the escape key as a string terminator (as well as command terminator) seems odd at first, but there are advantages. For one thing, it means that search and replace strings can contain the 'return' character within them. In other words, you can find and/or replace blocks of text which span more than one physical line.

Even more versatile is the ability to set up command sequences as 'macro' commands, which can be executed either in command mode or in immediate mode, by pressing the COPY key at any point within the text.

A text formatting program is included on the utility disc to give the editor word-processing capability. Indeed, the manual (a fine piece of documentation) was prepared using ADE's editor.

The BBC micro is already equipped with a very capable assembler, complete with conditional assembly and macro facilities, so how does the ADE assembler compare?

Since the source file is generated and saved separately by the editor and is never wholly resident in memory the only limit on assembler file sizes is that of the discs being used. If a tape system is in use, the object code is written to memory, as opposed to an output file directly, so in this case there is a limit on file size. The format of each line in an ADE assembler program is:

```
<label> <opcode> <operand>
<comment>
```

Each element on the line can be separated by spaces, or a tab character, which is expanded by the listing routine. This allows neat, formatted output without using up valuable memory. The label, if entered, can be of unlimited length, but only the first six characters are significant. For obvious reasons, try to limit your labels to six characters or less. This is the only point where I could fault the ADE assembler in comparison with the BBC version, but even then, the six-character restriction results in more acceptable assembler listings.

All labels are translated by the

assembler into upper-case. I was very pleased not to have to keep changing cases when entering mnemonics and symbols, which can be an irritation on the Beeb. The only reserved word in the assembler is the single letter A, for the accumulator addressing mode, so any other sequence of alphabetic characters is a valid label—even "mnemonics" such as LDA or STX can be used as labels (though they are not recommended).

Entries in the opcode field can be either a standard 6502 instruction mnemonic, an assembler directive, or the name of a predefined macro (a labelled sequence of commonly used instructions). A library of macros can be set up using the PUT command, and retrieved from the library file at assembly time with the GET statement.

Operands, if required, consist of an expression built up from symbols, arithmetic operators and constants. The following prefixes allow constants to be expressed in a number of forms:

```
no prefix - the default - a decimal number
$ or &    - a hexadecimal number
%         - a binary number
'         - an ASCII character value
```

A wide selection of data definition directives are also available.

Comments are separated from the rest of the line by either a ';' or '\'. Alternatively, an asterisk in column 1 denotes the whole line as a comment.

Conditional assembly in ADE is achieved by embedding code within IF ... ELSE ... FI (ie, ENDIF) directives. These can be nested up to eight levels deep. An additional command, QUERY, allows the values of labels to be changed from the keyboard during assembly to set the appropriate conditions required.

For all its assembly language powers, the unenhanced BBC micro has deficiencies when it comes to machine-code testing. The SPY debugger goes a long way towards correcting any shortcomings. The 'front panel' of the SPY utility gives a display of all internal 6502 registers and flags, together with a program/data area memory block and details of the hardware stack contents (a nice touch).

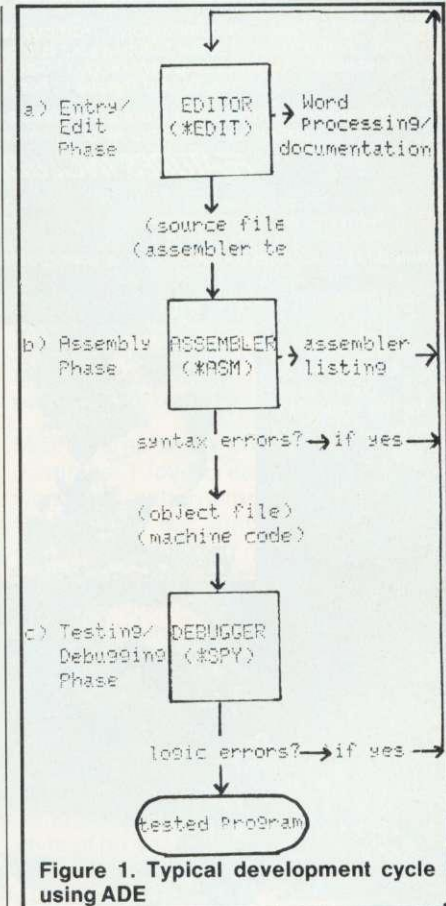

Figure 1. Typical development cycle using ADE

Breakpoint handling is rather basic, but with the ability to stop programs using \*FX100 or ctrl-F the result is a versatile package. I found the single-step feature particularly useful. There is the typical selection of commands to step forwards and backwards through memory, alter memory contents and registers, find specific byte patterns, and so forth. A brief summary of SPY commands is given in table 3.

Of course, the cost of ADE (and its range of facilities) shows that it is not aimed at the occasional dabbler in machine code. But when you consider that you are getting an enhanced assembler, capable debugger and an editor which doubles as a perfectly acceptable word-processor, £60 is not a high price to pay. Any programmer who does a substantial amount of assembly language work should give it serious consideration.

# ANSWER BACK SENIOR QUIZ GENERAL KNOWLEDGE

THE ULTIMATE EDUCATIONAL QUIZ  
FOR AGES 12 & OVER

BBC (32K)·ELECTRON

The ANSWER BACK Quiz provides an incredible adventure in education by combining a compelling Space-Age game with an immense series of questions on General Knowledge. The thought-provoking and well-researched quizzes contain an enormous total of 750 questions with 3000 answer options covering the following subjects:

- Astronomy  Music  Natural History  Famous People  Science  Sport  
 History  Art and Architecture  Know your Language  Discoveries and  
Inventions  Legends and Mythology  Geography  Literature  
 Films, TV and Theatre  Pot Luck

The highly sophisticated control program rewards each correct answer with another turn in the colourful, animated game.

## FEATURES INCLUDE

- Multiple choice answers  True or False?  Find the missing letters  
 "Pass" facility  Immediate correction of errors  Timer option  
 Performance summary  Re-run of questions passed or incorrectly  
answered  Full facilities for creating and saving an unlimited number of new  
quizzes

Available from your computer store or by mail order Price £10.95.

AVAILABLE SHORTLY:  
ANSWER BACK  
Junior Quiz  
for the under 11's



Other  
educational titles include...  
"The French Mistress"  
"The German Master"  
"The Spanish Tutor"



KOSMOS Software, 1 Pilgrims Close, Harlington, DUNSTABLE, Beds. LU5 6LX  
Telephone (05255) 3942

The ANSWER BACK Senior Quiz will educate and fascinate ANYONE over 11 years old.

KOSMOS SOFTWARE, 1 Pilgrims Close, Harlington, DUNSTABLE, Beds. LU5 6LX  
Please send me the ANSWER BACK Senior Quiz for the BBC/ELECTRON  
computer.

Mr/Mrs/Miss.....

Address.....

Post code.....

I enclose a cheque/postal order for £10.95 payable to KOSMOS Software

TELEFAX 109

## DOBSOFT FOR QUALITY AND VALUE

New high quality arcade, business and utility programs.

**LASERS:** BBC 32k and Electron, 1 or 2 players, £6.95. Avoid divorce, buy this two player dynamic machine code space battle game. Beware of the hostile invader. Each player controls a highly manoeuvrable laser base which fires photon bolts. Try and beat the computer as well.

**TOOLKIT:** BBC B: Spiral bound User Guide included, £19.95. An 8k utility EPROM containing 27 commands for graphics; file handling and "debugging". It simply pops into a paged ROM socket and is constantly available for use. Some of the commands are:

- \*BIG Prints enlarged characters in any graphic mode.
- \*CENTRE Centres text in any standard screen mode.
- \*DEFCHAR Defines characters on a grid and enables a 'macro' character of 16 x 16 pixels to be created, which then can be saved to disc or tape.
- \*DEFLIST Lists all defined procedure and function names.
- \*FIX Repairs a 'Bad Program' and then 'OLDs' it.
- \*FSAVE Saves files to tape 1.5 times faster than normal, which later can be loaded with \*FLOAD.
- \*MMOVE A memory move command suited for discs and sprites.
- \*TAPEDISC Takes a specified number of files from tape and puts them on to disc, preserving file attributes.
- \*VARYLIST Lists all declared variable names in a program.

**CESIL:** BBC 32k and Electron. Instructions included, £6.95. Full implementation. Ideal for 'O' level work. Includes a trace facility.

**DISKWORK:** A database for BBC B and discs. Instructions included, £10.95. Over 400 records on average disc. Up to 25 fields, maximum field size 255 characters. Index on field; search on field etc.

Good programmers wanted, will pay excellent rates. Please send a SAE for other programs.

DOBSOFT (Dept. AU),  
CENTRAL BUSINESS COMPLEX, ANDREWS BUILDINGS,  
67 QUEEN STREET, CARDIFF CF1 4AY.

## THE MIDDLESEX CENTRE FOR BBC

Everything for the Acorn/BBC Owner under one roof

ACORN ELECTRON - £199 BBC MODEL 'A' - £299  
BBC MODEL 'B' - £399

Disk Drives by: TEAC,  
MITSUBISHI, AMS, CUMANA,  
KORMANDI, TORCH and  
others from £169.00

Monitors by: NOVEX, PHILIPS,  
MICROVITEC, FIDELITY from  
£79.95

Printers from EPSON, STAR, BIT,  
SHINWAH, BROTHER, JUKI,  
UCHIDA etc, etc from £89.95

Accessories: Lightpens, Dust  
Covers, Joysticks, Monitor Stands,  
Cases, Leads, Floppy Discs and  
much much more

SOFTWARE: GAMES, BUSINESS  
& EDUCATIONAL plus  
PROGRAMMING AIDS on  
Cassette, Disk or Rom.

UPGRADES, ROM FITTING,  
REPAIRS, TESTING etc, etc

# PLUS!

Special Word Processing, Business  
and Programming starter Kits  
offered to meet your requirements  
at good savings.

WE WILL BETTER ANY GENUINE OFFER IF THE PRICE IS LOWER THAN OURS

## SCREENS MICROCOMPUTERS

(A Division of Mayfair Computer Services Limited)

6 MAIN AVENUE, MOOR PARK, NORTHWOOD, MIDDLESEX, ENGLAND  
Tel: NORTHWOOD (09274) 20664

- ★ Open 6 days per week. Easy Parking.
- ★ Worldwide fast, reliable mail order.
- ★ Official Orders/Enquiries welcome.

Visa . Access . Amex . Diners Club . Instant Credit



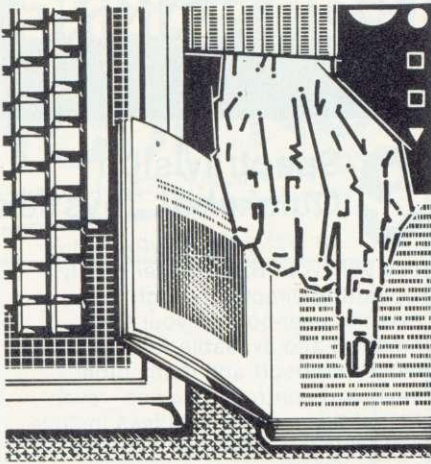

## JOBS FOR YOUR

### BEEB OR ATOM

**'Interfacing Projects for the BBC Micro' by Bruce Smith, Addison-Wesley Publishing, 134 pages, £6.95**

AMONG the multitude of computer books that you can find on almost any bookseller's shelves, you will find few relating to the subject of interfacing a machine to the world outside. In the headlong rush to become a computer literate society, we are in danger of overlooking this aspect of computing, and yet it is one that we encounter every day, and the one that is having the most profound effect on our life-style.

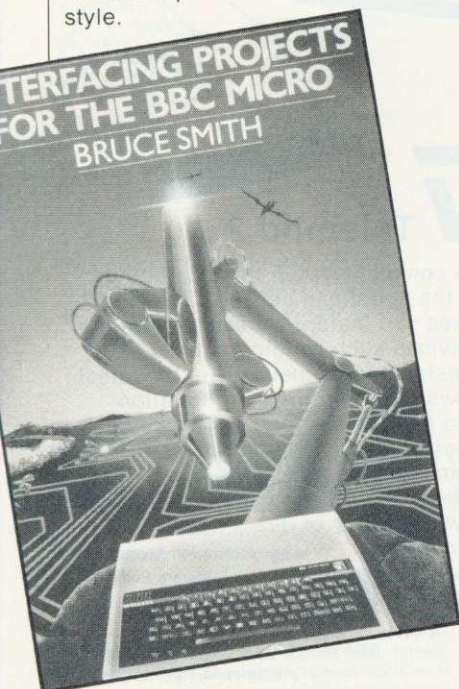

As it happens, the design of the BBC Micro – and, indeed, the Atom – is particularly suited to real time control and data capture and this slim volume will start you along the road to a new horizon.

Written by Bruce Smith, it begins by introducing you to the arithmetic and electrical concepts behind the various user ports and shows you how to read and write to them. Chapter 3 is devoted

to the VIA port and gives a detailed description of the lines and controls available on the 6522, which is used for control in all the book's projects. Chapter 4 shows you how to use the indirect addressing that Acorn prefers you to use (to make things compatible with the Tube) and chapter 5 details the physical connection points before describing the construction of a multiple output power distribution board.

The rest of the book puts theory into practice by describing projects for you to build. These comprise: an automatic light switch; a door bell and rain detector (presumably in case you live in a house without windows!); a temperature monitor; sound detector; joystick controller; light pen; D/A converter; light sequencer (disco lights); EPROM programmer; and finally, and best of all, an X-Y plotter. The saving on this last item alone is well worth the price of the book.

All the projects are described in simple, easy-to-understand language and would be suitable for anyone with experience of wielding a soldering iron. All the projects in the book are available in kit form from Watford Electronics. Do not be misled by the title. Most of the projects are suitable for the Atom as well (I understand that many were developed on the Atom) and the translation of the control programs is an easy matter.

So here is a book different from the norm, simply and clearly written. It is recommended for any Beeb or Atom owner who wants really useful applications for his machine. **Barry Pickles**

## GAMES WITHOUT

### THE FRILLS

**'36 Challenging Games for the BBC Micro' by Tim D Rogers and Chris Calender, Interface Publications, 270 pages, £5.95**

YOU can't really expect arcade quality from a games book costing £5.95, and you certainly don't get it here. The 36 programs in this new collection from Interface are all reasonably well-written, with good use of the Beeb's features (colour, sound and user-definable graphics) but the end results are, frankly, not very exciting.

Fortunately the programs are not too long, so you don't have to spend an age before you learn how good (or bad) they are. While it is not purely a book of listings, the notes accompanying each program are sketchy to say the least, with only the briefest outline of major processes. All the same, the programs

are straightforward and not terribly difficult to follow. Meaningful variable names are not generally used, the justification being that resident integer variables enabled the programs to run as quickly as possible.

The book would, perhaps, be of use to those wishing to pick up the rudimentary techniques of writing games programs in BBC Basic. The basics are there, and those with the time and inclination could, with effort, add the frills that the games need. Perhaps this is the 'challenge' to which the book's title refers.

Verdict: pretty mediocre, but at 17p a program... **Vincent Fojut**

## GRAPHICS FOR

### MATHS DUFFERS

**'Microcomputer Graphics' by Roy E Myers, Addison-Wesley Publishing, 282 pages, £9.95**

MICRO graphics is one of my favourite pastimes. I love creating strange and wonderful patterns on the screen. Unfortunately, my maths suffers from years of neglect, so my efforts tend to be a hit and miss affair. I was, therefore, delighted to see this volume, which explains the theory behind such things as translation, rotation and hidden-line removal.

Originally published in the US, it is written in the American idea of a 'user-friendly' style. For example, chapter 6 begins 'Warning – read slowly. Mathematics ahead!' If you can live with this style of prose, the book will impart useful information, illustrated with dozens of example programs.

There is a considerable amount of maths to digest, but it was put simply enough for my ageing brain to comprehend.

All the programs are written for the Apple II, but the graphics commands are explained and easy to translate to Atom or Beeb Basic. In fact, the programs are almost directly translatable to both machines, since the standard Apple hi-res mode is a 280 x 192 matrix. All aspects of graphics are covered in the book's 282 pages.

The bible for graphics programmers is *Fundamentals of Interactive Computer Graphics* by Foley and Van Dam (also published by Addison-Wesley), but, as well as being quite expensive, it is written in Pascal and requires a higher degree of mathematical aptitude. This book is in Basic and starts at a much simpler level and I would recommend it to anyone interested in graphics. **Barry Pickles**

# HERE'S SEVEN MORE REASONS FOR MAKING MICROSTYLE NO.1

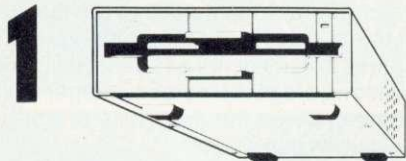

## 1 Microstyle Disk Drive Option 1. Single drive

Microstyle 'Options' - A system of disk drives designed to be flexible, cost conscious and practical. If you're after a single drive choose 'OPTION 1': 100K 5 1/4" Single Slimline disk drive. Uses BBC power supply. Includes 'utilities disk', all leads and manual.

**£185.00**  
+ £6.00 securicor del'y

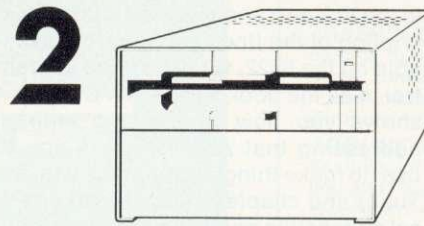

## 2 Microstyle Disk Drive Option 2. Single drive in dual case

Choose 'OPTION 2' now and allow yourself the flexibility to add a second drive later: specification as Option 1, mounted in dual case.

**£245.00** + £6.00 securicor del'y

## 3 Spectravision Quickshot Joystick

At last a quality joystick for use with your BBC (model B only) Operating directly through the existing user-port on your BBC model B and available for use with most Acornsoft and many other keyboard controlled games - even Planetoids - these joysticks include a machine-code "driver program on tape, which converts to remote control operation.

**£19.95**  
+ 75p p&p

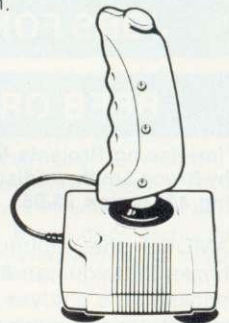

NB: Planetoids and certain other games may still require the use of some keyboard commands.

## 4 Microstyle Plinth

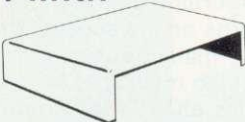

Top value strong, safe metal plinth for your monitor, disk drive, etc.

**£14.95** + £2.50 p&p

# MICROSTYLE YOUR NO.1

FOR CHOICE, VALUE & SERVICE

## 5 Nordmende Monitor

The NORDMENDE 14" colour monitor combines true RGB performance with U.H.F. T.V. value. Fully BBC compatible, this dual purpose design compares favourably with most quality, stand-alone RGB monitors while offering far greater value to the whole family.

R.G.B. Cables extra-please state Commodore 64/BBC **£7.50**

**£249.00**  
+ £6.00 securicor del'y

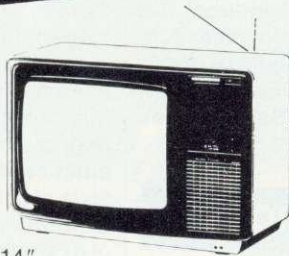

## 6 BBC Advanced User Guide

An essential supplement to the 'User Guide' provided with the BBC micro. Some of the many areas covered are: The BASIC assembler/A full 650Z code ref. section/Complete description of ALL the 'FX - OSBYTE calls/Implementing paged Rom software and much more.

**£12.95**  
+ 50p p&p



## 7 Telemod 2

By connecting your microcomputer to the telephone network, Telemod 2 gives you instant access to viewdata services such as Micronet 800, Prestel, and Homelink. Get the latest news, weather, travel information and many other topics of immediate interest. Take advantage of homebanking, teleshopping, CitiService financial information, and a wide variety of direct - booking services.

Viewdata and Communications Software Packages. These are required in addition to Telemod 2 to allow you to connect your microcomputer to viewdata services such as Micronet 800 and Prestel. They contain appropriate hardware interfaces, specially developed software, any necessary connectors and full instructions.

**£99.00** + £2.50 p&p

(Price includes leads & driver cassette, ROM version please add £5.00 extra.)

**All prices advertised include VAT**

**Please Note:** While Microstyle will endeavour to maintain sufficient stocks of items currently or previously advertised we regret that all items are offered for sale subject to availability from manufacturers.

## TO ORDER

Please complete coupon in block capitals, enclosing your remittance and send to: Microstyle Dept M.O., 67 High St., Daventry, Northants. Tel: 03272 78058.

Name .....  
Address .....  
..... Daytime Tel. No. ....

Order by phone: please telephone 03272 78058 quoting your Access/Barclaycard number.



Please remember to include appropriate post & packing charges. Allow 28 days for delivery.

Quantity	
<input type="checkbox"/>	1. Option Drive 1 at £185.00 + £6.00 Securicor Del.
<input type="checkbox"/>	2. Option Drive 2 at £249.00 + £6.00 Securicor Del.
<input type="checkbox"/>	3. Quickshot Joystick at £19.95 + 75p p&p
<input type="checkbox"/>	4. Microstyle Plinth at £14.95 + £2.50 p&p.
<input type="checkbox"/>	5. Nordmende Monitor at £245.00 + £6.00 Securicor Del.
<input type="checkbox"/>	RGB Cables (extra) at £7.50 Commodore 64/BBC (delete)
<input type="checkbox"/>	6. BBC A.U. Guide at £12.95 + 50p p&p.
<input type="checkbox"/>	7. Telemod 2 at £99.00 + £2.50 p&p

Total price including post & packing Cheques may be made out to MICROSTYLE

£

AU7-84



## MICROSTYLE YOUR NO.1 FOR CHOICE, VALUE & SERVICE

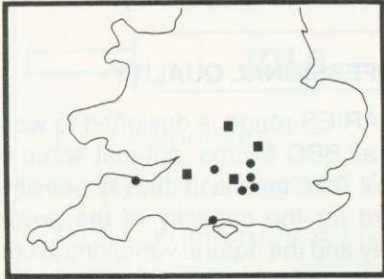

Shops: ■ Dealers: ●

### The network is spreading...

The Microstyle dealer network is growing all the time. Check out the list below for a dealer in your area.

**Minehead Radio Ltd**  
Radiovision House,  
Friday Street,  
Minehead, Somerset.  
Tel: 0643 5077

**Microwise**  
21 Duke Street,  
Reading, Berks.  
Tel: 0734 591816

**Eric Evans**  
84 Fleet Road,  
Fleet, Hants  
Tel: 02514 7625

**Frome Computers**  
21 Fromefield,  
Frome, Somerset.  
Tel: 0378 66883

**Alan Sinclair**  
6 Church Street,  
Basingstoke, Hants.  
Tel: 0256 21307

**Barbury Computers**  
89 Victoria Road,  
Swindon, Wilts.  
Tel: 0793 611487

**Bridge Computers**  
23/25 New Street,  
Lymington, Hants.  
Tel: 0590 77001

**Family Computers**  
40a Bell Street,  
Henley-on-Thames,  
Oxon.  
Tel: 0491 575744

#### Trade only enquiries:

If you would like to see your company name featured here, please contact Lyn Farmer on Newbury (0635) 42570 for further details.

**MicroStyle**  
THE HOME COMPUTER PEOPLE

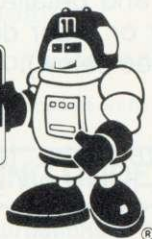

#### Branches:

**The Aylesbury Computer Centre**  
52 Friar's Sq., Aylesbury.  
Telephone: Aylesbury (0296) 5124

**The Bath Computer Centre**  
29 Belvedere, Lansdown Road, Bath.  
Telephone: Bath (0225) 334659

**The Daventry Computer Centre**  
67 High St., Daventry.  
Telephone: Daventry (03272) 78058

**The Newbury Computer Centre**  
47 Cheap Street, Newbury.  
Telephone: Newbury (0635) 41929

## HANDBOOK FOR

### DISC USER

'The BBC Microcomputer Disc Companion' by Tony Latham, Prentice-Hall International, 186 pages, £7.95

FEW peripherals enhance the BBC micro as much as discs, and despite the price, an increasing number of Beeb owners are taking the plunge. However, sources are many and varied, as is the level of accompanying documentation. So a book that purports to give a comprehensive guide to using discs with the Beeb is more than welcome.

The book starts with an introduction to disc handling and gives a resumé of the standard Acorn DFS commands. It then goes on to file handling (both in Basic and assembler) and covers file-related Operating System routines (OSFIND, OSARGS, etc). Later chapters provide complete program listings for a number of useful disc functions, from formatting and verifying routines to a simple text-handler or word-processing program. To round off, the author gives technical details and performance characteristics of the popular disc variants available.

Much of the material will already be familiar to prospective readers, being available in some form or other in various documents. For example, those already using discs will presumably already have a list of the commands available with their DFS. Similarly, most users will almost certainly have a formatter/verifier at their disposal. On the other hand, there is something to be said for having all disc-related information, even if duplicated, present in a single volume. Even existing disc owners may find useful information in the chapters covering file handling and random access, for example.

As for the provision of format/verifier routines, the author argues that disc drives originally intended for other (older) computers could be put to use with the Beeb, providing discs can be formatted appropriately—hence the programs. For this reason, the book could prove particularly attractive to schools and other establishments with limited resources eager to make the most of existing equipment.

*Disc Companion* may be beneficial to those considering acquiring discs. The well-rounded overview of disc usage with the BBC micro should help clarify any outstanding areas of confusion, and provide useful guidelines for making the right purchase.

Vincent Fojut

## FUN MATHEMATICS ON YOUR MICROCOMPUTER

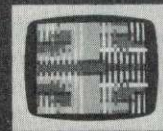

CZES KOSNIOWSKI

### DOESN'T ADD UP

'Fun Mathematics on your Micro-Computer' by Czes Kosniowski, Cambridge University Press, 195 pages, £4.95

THIS book aims to cover some areas of mathematics, illustrating the subject by the use of entertaining computer programs. The choice of topic is broad, covering school mathematics and areas not taught outside universities.

Having read the contents page, I was very disappointed by the rest of the book. It gives an impression of having been written down in one go and never checked. Time after time the author fails to explain terms before he uses them, and sometimes doesn't explain them at all.

The subject-matter is, however, interesting and this book could have a role in computer clubs where experienced help is at hand. It might particularly interest the A-level mathematician who wants to broaden his mathematical knowledge.

Like many things in the world of personal computers this book claims to be more than it is. It does not *teach* mathematics, but merely *describes* parts of the subject. Never before have I seen someone claim to teach differential calculus in two pages.

Neither is it, as it claims, a book for the computer novice. The programs are not simple, and are complicated by Czes Kosniowski's approach to the computer author's bogeyman, portable Basic. He has tried to write programs (using his ACT Sirius 1) that are easily adapted for many different personal computers. The result is programs that will please no-one: verbose and unstructured in the extreme, and using a very small subset of Basic.

I cannot recommend this book.

Jeremy Bennett

# The Aries File

## CRUSHED BETWEEN AN IRRESISTIBLE FORCE AND AN IMMOVABLE OBJECT?

If your high-resolution screen is squeezing you from one side, and your operating system from the other, isn't it time you tried the ARIES solution? ARIES-B20 is the board which banishes forever the conflict between screen graphics and program memory. "bad mode" and "No room" become nightmares of the past when your Beeb possesses this unique expansion.

Unlike "sideways-RAM" systems, ARIES-B20 offers you *transparent* access to 20K of extra memory, replacing the RAM swallowed up by the high-resolution graphics modes. The extra RAM is switched in completely automatically, meaning that your existing software can make use of it *without modification*.

This means that if you're a programmer, you have up to 28K RAM available for BASIC, FORTH, LISP, BCPL, LOGO and COMAL programs in *ANY SCREEN MODE*. If you're a business user, the extra memory is used by

VIEW, VIEWSHEET, WORDWISE and many other applications. And if you're a scientific type, you can get access to a massive 47K of data storage using the Acorn-approved ARIES ★FX call.

### COMPATIBILITY ASSURED

With the huge range of Beeb add-ons that are becoming available, compatibility has become a real headache. Every extra you buy your computer might lock you out from a host of others, even if it works with those you already possess.

ARIES-B20, designed by BBC Micro experts, offers you true upgradeability. In addition to the rest of the ARIES family (the ARIES-B12 ROM expansion board and the ARIES-B488 IEEE-488 interface unit), ARIES-B20 is compatible with double-density disc controllers, second processors, ECONET, hard discs, EPROM programmers and

much more. Several major companies now test all their products with ARIES-B20 to ensure compatibility.

### PROFESSIONAL QUALITY

The ARIES range is designed to work with *all* BBC Micros, not just some of them. This means it has a sensible regard for the capacity of the power supply and the natural variations in critical timings between machines. All new ARIES products are subjected to brutal testing in extreme conditions before they are released on the market.

In quality of construction, the ARIES range sets a standard against which others are judged. Custom-made connectors eliminate the damage to the BBC machine caused by inferior products. Units are electronically tested before, during and after manufacture. And all this is backed up by the ARIES 1 year no quibble guarantee.

## WHAT THE PRESS SAID

"the most exciting add-on"  
- Times Educational Supplement, March 1984

"a very professional product"  
- A & B Computing, March/April 1984

"an attractive solution to the lack of sufficient memory on the Beeb"  
- Beebug, March 1984

"this is an impressive piece of equipment in its own right and deserves to be taken seriously"  
- Acorn User, April 1984

"the trouble with a paged RAM system is that the software has to be aware that it is there. The Aries RAM board gets round this limitation brilliantly"  
- The Micro User, June 1984

## NOW AVAILABLE THROUGH DEALERS

To cope with the continuing growth of demand, the unique ARIES-B20 RAM expansion has now been made available through selected dealers. Although ARIES-B20 can be fitted by a complete layman in a matter of minutes, a fitting service is offered by approved dealers to those customers unwilling to delve inside the case of their BBC Micro.

The recommended retail price of ARIES-B20 is just £115 (inc VAT) for the B20 board, operating system extension ROM and detailed manual. Enquire at your local dealer or order direct by post from the Manufacturers (see below).

(Machine requirements: Model 'B', MOS 1.2. Hardware plugs into CPU socket, software uses one sideways ROM socket)

### How to order:

Send cheque or postal order made payable to:  
Aries Computers  
and forward to:

Aries Computers  
Science Park, Milton Road,  
Cambridge CB4 4BH  
Telephone Cambridge (0223) 862614

Aries Computers is a trading name of  
Cambridge Computer Consultants Limited.

Please send me (Qty.) ..... ARIES-B20(s) at £115.00  
(incl. P.P. & VAT)  
I enclose a cheque/postal order made payable to  
Aries Computers for £. ....  
Signed .....  
Name (block letters) .....  
Address .....  
..... Post Code. ....

# SOFTWARE CHART

	TITLE	PUBLISHER	PRICE	MICRO
1 (1)	Snooker	Visions	£8.95	B/E
2 (11)	Twin Kingdom Valley	Bug-Byte	£9.50	B
3 (3)	White Knight 11	BBC Soft	£10.00	B
4 (2)	747 Flight Simulator	Doctor Soft	£8.95 (£11.95)	B
5 (19)	Hopper	Acornsoft	£9.95	B/E
6 (5)	The Hobbit	Melbourne House	£14.95	B
7 (14)	Chuckie Egg	A&F Software	£7.90	B/E
8 (16)	Hunchback	Superior	£7.95 (£11.95)	B
9 (13)	Fortress	Pace	£8.95	B
10 (18)	737 Flight Simulator	Salamander	£9.95	B/E
11 (—)	Ghouls	Program Power	£7.95	B
12 (8)	Killer Gorilla	Program Power	£7.95	B/E
13 (10)	Zalaga	Aardvark	£6.90	B
14 (9)	Gorph	Doctor Soft	£8.95	B
15 (4)	Snapper	Acornsoft	£9.95	B/E
16 (17)	Dare Devil Dennis	Visions	£8.95	B
17 (—)	Lords of Time	Level 9	£9.90	B
18 (—)	Cylon Attack	A&F Software	£7.90	B/E
19 (—)	Dodgy Dealer	O I Consultants	£6.50	B
20 (6)	Transistor's Revenge	Softspot	£7.95	B

B=BBC E=Electron Prices in brackets are for disc version

## BUBBLING UNDER

Hulk (Adventure International)  
Empire (Shards)  
Jet Power Jack (Program Power)

Compiled by RAM/Computer

Pengwyn (Postern)  
Battle Tanks (Superior)  
Aviator (Acornsoft)

NO NEW Top Ten entries in this tasting of the vidiot universe—the nearest is the pitter-patter of tiny Ghouls at number 11. The chart seems to have settled down, with several favourites keeping their position for at least three months.

Among these are *Snooker*—one of Visions' releases from last year—*Snapper*, *747*, *Twin Kingdom*, *Hobbit*, *Chuckie Egg*, *White Knight*, *Zalaga*, and the not-so tiny feet of *Killer Gorilla*.

It's quite amazing to think that in this, our second

birthday issue, *Snapper* is still going strong. It made its appearance, along with Acornsoft's *Defender* and *Monsters*, in the first-ever issue of *Acorn User*.

Another in the adventure style has appeared, *Lords of Time* from Level 9, a publisher that certainly appears to be keeping up its quality. Then *The Hulk* is bubbling—undoubtedly the result of large orders from the multiple stores, as we haven't seen a copy yet.

## SOFT ●● OPTIONS

OPTIMA Software's latest release for the Beeb, *Bedbugs*, certainly comes up to scratch. This original arcade game has already had some mothers up in arms as jam sandwiches come to the aid of the game's bedbug-ridden hero.

*Castaway* is a new adventure game from **Simonsoft**, set in mode 7 graphics. Irate gardeners, beanstalks and priggish chemistry teachers are among the problems you'll encounter on the 'Three Island Adventure' as you go in search of priceless treasure.

A sealed envelope is provided for defeatists which offers them hints.

*Computer Assisted Table Bingo* is **Resource Facilities'** way of making the learning of multiplications from 1\*1 to 10\*10 enjoyable for children (or adults!). Calls are made for a 'line' or 'house' when a player obtains three or nine correct numbers respectively. Tel: (0422) 65935.

*Integrated Accounting* is business software for the Beeb from **Diamondsoft**. The software is supplied on 40-track disc and comes with a comprehensive user manual. Features include areas such as purchase ledger, sales ledger, nominal ledger, cash book and VAT analysis. Tel: (061) 485 8705.

*One-Disc Home Office* from **Doctor Soft** provides the first integrated program for the Beeb to offer word processing, an address database and spreadsheet linked together on a single disc. The disc is supplied with a 12-page manual. Tel: (0903) 206076.

The microdisc invasion gathers pace as **Beebugsoft** breaks into the new 3½in market with six titles. If your spelling is really bad then *Spellcheck*, for use with Computer Concepts' Wordwise will be of interest. It takes a Wordwise file and searches through it for spelling mistakes, highlighting any it encounters so that you can then edit. Rent-a-ghost becomes reality with the *Sprite Utilities* package, and the other titles are *Masterfile*, *Teletext Pack*, *Paintbox* and *Design*.



# Software News



INNOVATIVE  
BBC SOFTWARE

from the professionals

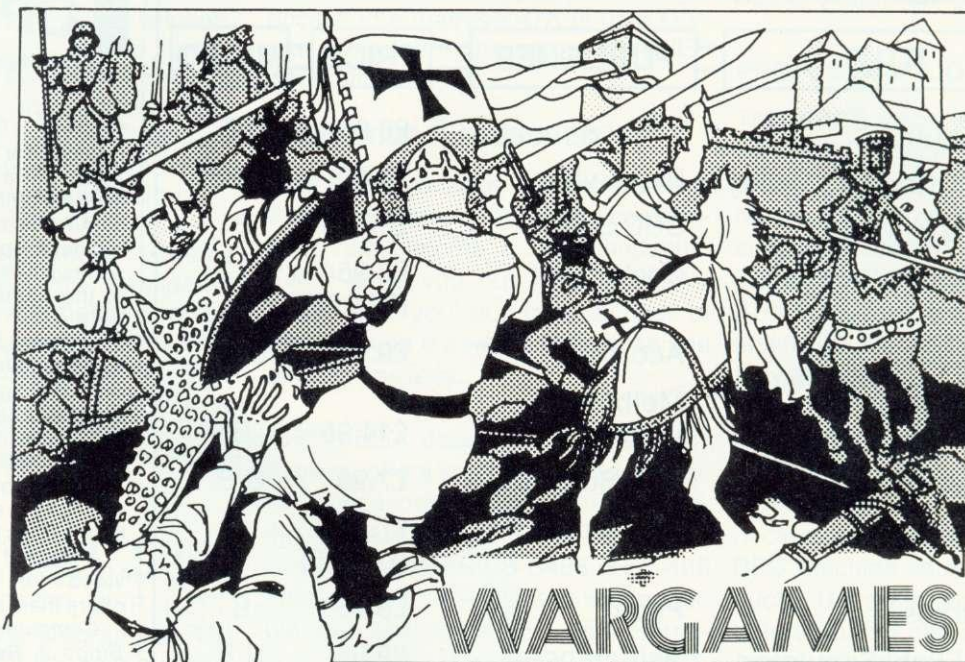

Computer wargames are played against the background of a map. On the BBC these are particularly attractive. All the games are played in a similar manner. Troops are moved from one area to another, taxes levied, and so on. Battles are fought and wars are won or lost.

### WILLIAM THE CONQUEROR

The player takes the part of William, Duke of Normandy, in 1047. William's Duchy consists of eight provinces, and the purpose of the game is for William to establish complete control over his realm, which is no small task. He dies in 1087. A good player will not only hold the original provinces, but also have captured two others. He must also, incidentally, have successfully invaded England.

### KING ARTHUR

Most wargames stretch to a couple of hours, some longer. King Arthur is a short one running about twenty minutes. Set in the time of the Anglo Saxon invaders, King Arthur must protect this island and hopefully drive the Anglo Saxons into the sea.

### EMPEROR

The scenario is the first four centuries A.D. in the Roman Empire. The player takes the part of the Emperor and must pit his wits against invading Barbarians, rebellious provincials and treacherous Roman generals. Even the Plebs of Rome will have to be placated with bread and circuses if the Emperor is to keep his head and his throne. In that Emperor is played against the background of the biggest geographical area of all our wargames, it is probably one of the most interesting.

### CRUSADERS

The player takes the part of the King of Jerusalem, and has to rule his kingdom from 1169 to 1177. The ultimate aim is to prevent any incursions by the invading Saracens. There are a total of 48 fortresses, all interconnected by caravan routes. The program has a rudimentary artificial intelligence, inasmuch as the Saracens attempt to siege and take castles and fortresses that they have not previously moved to. Thus, a Saracen army that has been sieging for a few years may be reinforced by a new army.

### NAPOLEON

Unfortunately Josephine does not appear, but Napoleon is probably one of the most absorbing wargames in that it was such an interesting period of history. Needless to say, the object of the game is for Napoleon Bonaparte (the player) to conquer Europe completely. Battle commences in June of 1798 and the player has until the end of 1815 in which to manoeuvre the initial six armies in such a way as to defeat the opposing forces.

Any one wargame (excluding King Arthur) ...	£13.50 + VAT =	£15.53
Any three wargames ... .. .	£30.00 + VAT =	£34.50
King Arthur ... .. .	£ 9.50 + VAT =	£10.93

P & P on one wargame 75p. P & P on three wargames £1.50.

TEL: [0424] 220391/223636

**MOLIMERX™ LTD**  
A J HARDING (MOLIMERX)

TELEX 86736 SOTEX G

1 BUCKHURST ROAD, TOWN HALL SQUARE, BEXHILL-ON-SEA, EAST SUSSEX.

SOFTWARE CATALOGUE ----- A4 size stamped addressed envelope for 21p.

## RIDING HIGH

## WITH DENIS

'Daredevil Denis', Visions, BBC B and Electron, £7.95

COMPUTER game writers have fertile imaginations. It never ceases to amaze me how a similar concept in a game can be presented in so many different ways. Take *Daredevil Denis*, for example. It represents a novel approach to getting from one end of a screen to another while jumping over or ducking under various objects en-route – a *Killer Gorilla* type of game, but with some original effects.

The object is to manipulate Denis, a stuntman, around three scenarios. These are land, where Denis rides a motorcycle; sea, where he controls a wetbike (a James Bond contraption); and snow, in which Denis dons his skis. The screen display consists of four evenly spaced horizontal lines, representing the landscape, and Denis rides (or skis) along the landscape from the top line to the bottom.

Denis' progress can be controlled from three keys: space bar to jump, Shift to accelerate, and Return to stop. There are six skill levels, ranging from Novice through Oscar Nominee to Ace, within



each of which there are six intermediate stages.

Among the original effects is the 'Denis the Stuntman' theme, which holds it all together. This is carried through even to the high score table, which shows your achievement in terms of wages earned. Each new life (there are three) is announced with the slam of a clapperboard closing (this is a film set, after all) and a new 'take'.

But there are irritating things about the software. Although the sprites are well defined, and there are 30 of them, the screen has an empty look. The graphics can be unpredictable when there is a crash and this can detract from the realism of the game. On the plus side, however, the break key is disabled, including control/break. The sound

effects are good, especially those when Denis is on skis. The graphics are smooth during a jump, and a crash is fun to watch at first as Denis is thrown from his vehicle and lands upside-down flailing his legs.

*Daredevil Denis* seems to have been written with a sprite-making package, yet despite its well-defined characters the screen display is a disappointment. Nevertheless, I found the game quite challenging and the higher skill levels proved difficult. A pity the screen isn't more fully utilised.

Dee Vince

## BRIDGE WITH A

## FEW GAPS

'Contract Bridge', Alligata Software, BBC B, £9.95

THIS piece of software will give great pleasure to keen bridge players although it has limitations. Load it and you can get excellent practice at bidding and playing hands with infinite variation. It plays near standard if a little conservative Acol-type bidding with pre-emptive jump bids, strong two and Stayman convention.

You play south except when north is declarer, so half the hands are yours to play. You are offered the hand and previous bids, and a prompt asks you to call. You can see the last trick, faintly visible on the screen. Once contract is reached you play normally, the tricks being counted for you. At the end of each trick all the hands are revealed and you can analyse the bidding and play at leisure before going on with the exercise.

*Contract Bridge* provides very good entertainment and my impression is that the proportion of hands with unusual distribution is above what would be expected, although that tends to add interest.

There are limitations to the program that are not obvious from the description on the box, and it is as well to be aware of them in advance. There's no scoring or provision for doubles, and each hand stands alone, so bids such as the take out double which might be conditioned by such situations are not supported. Nor is there a means of declaring, so you must play every hand out to the bitter end, and the absence of a slam convention makes the frequent long, strong suits hard to make the best of in bidding. More annoying was the fact that the machine plays a little too fast for me, especially when any of the hands, including declarers, is without a choice. Finally, there's a bug in the program that I was unable to trace which gives 'No room at line 6650' about once an hour, apparently at random.

These are small complaints about a good idea which will give pleasure to the many bridge-playing model B owners and the game is entertaining and useful at a reasonable price. A much more sophisticated version is apparently coming.

Roger Carus

## HOLOCAUST IN

## THE HOLD

'Demolator', Visions, BBC B, £6.95

THE Demolators are ghost-type nasties whose sole aim is to destroy the human cargo held in cryogenic suspension aboard the Battle Star *Quinn* (Visions denies that it is named after *AU's* illustrious editor!) as it transports the last remnants of Homo sapiens across the galaxy. Patrolling the cargo bay is the Phobe, the ultimate robot, and you have to manoeuvre it around (with keyboard or joystick), picking off the aliens. The Demolators have the advantage, though, of being able to move through any objects they encounter, whereas the Phobe must dodge these obstacles, at the same time taking care not to blow itself to bits on any of the mines lying around.

Points are scored by zapping the Demolators with the inevitable ultrasonic cannon.

The Demolators have their allies,

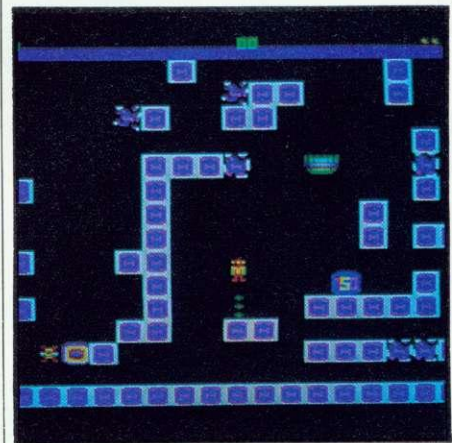

too. The Minor is a real beast. He appears randomly and if you don't zap him he mutates into a deadly mine which cannot be destroyed and eventually the Phobe can be hemmed in. The Protector is a bit like a mobile Minor that fires back (not very nice), while the Tractor actually homes in on you.

*Demolator* is well-presented, making good use of sound and colour. The graphics are very good, and excellent, flicker-free use of sideways scrolling gives a good impression of travelling down a long cargo hold.

The game gets more difficult as you progress and it apparently has 24

# HOW TO TURN YOUR SOFTWARE INTO HARD CASH.



Turning a great idea into a profitable idea isn't easy.

It needs skill, patience and sheer hard work. But to be really profitable, it also needs the backing of a large, respected company.

At British Telecom we are now looking for writers of games and educational programs to help us launch a new and exciting range of software.

If we like your idea we'll send you a cheque straightaway as an advance on royalties.

Then we'll package your program, advertise it and distribute it with the care and attention you'd expect from one of Britain's biggest companies.

So if you'd like to turn your software into hard cash, simply send your program, on cassette or disk, to

**FIREFLY**  
SOFTWARE



British Telecom,  
Wellington House, Upper St. Martin's Lane, London WC2H 9DL.

stages – I couldn't get past stage 4 after about an hour's practice. The game is complete when you have used up your available lives, of which you have three.

The verdict: slightly above average, with good graphics. **Bruce Smith**

## WIREFRAME

## ENEMY

'3-D Tank Zone', Dynabyte Software, BBC (32k), £8.95

THIS offering from Dynabyte follows Acornsoft's *Aviator* as an innovative piece of software that makes use of the Beeb's fast processing speed at machine level to produce three dimensional wire-frame graphics. For the uninitiated wire-frame means that the object, in this case a tank, is displayed simply as a 3D outline figure, with little or no detail. This doesn't mean the effect is unrealistic. On the contrary, it stimulates the imagination and I prefer it to minuscule overdetailed characters.

Once *3D Tank Zone* is loaded you find yourself at the controls of a tank looking out onto a landscape containing a multitude of pyramids (or are they hills?). The turret may be rotated to face one of the other three points of the compass to show missile silos, part of a city and what look like volcanoes erupting in the distance.

The on-board radar, which is rather disappointing, shows a single point to represent the position of an attacking enemy tank, located visually by swinging the turret around. By using the keyboard or a joystick the sights of the anti-tank missile launcher are aligned and the deterrent launched. This process is harder than you might expect. The sights are not the cross-wire type but move up and down the side of the screen and across the top of the screen, so it takes some skill to line them up. The marauder is also manoeuvring smoothly at an often unpredictable speed so he's easy to miss. Once launched, the missile whistles away and if you're on target the enemy tank is obliterated – and another appears on the radar screen.

In the skies waves of lifelike jets and helicopters are on the attack. You can shoot them down using the on-board anti-aircraft cannon, the sights for this being the standard cross-wire type. Only one weapon can be fired at a time.

Points are awarded for destroying any enemy hardware, tanks carrying the greatest value. The object of the game is to destroy as much of the enemy before he pops your clogs, so an eye needs to be kept on the condition of the energy banks.

As with many of the programs marketed today, little information about the program is provided on the card insert. I wish software houses would at least print the key/joystick functions so that they may be readily referred to. It's annoying to have to reload the program to note them down.

Really, *3D Tank Zone* follows the old familiar pattern – zap-zap, bang-bang – which is disappointing. However, the graphics are its main selling point and they work exceptionally well, not up to the *Aviator* standard but an honourable second. **Bruce Smith**

## GALLONS

## OF TROUBLE

'Jet-Power Jack', Micro Power, BBC B, £7.95

JET-POWER Jack, the inter-galactic hitch-hiker, has been kidnapped. His captor is no less a character than Nogrob the Terrible, who runs the Botch system.

Jack is held in a garage and must recover vital fuel pods to refuel the waiting starships. As usual, his oxygen supply is limited, so he has to be quick. The garage is filled with obstacles, but luckily Jack has a turbo-booster on his back (the Jet-Power) so he can move from level to level. In doing so, he must avoid the live light fittings in the ceiling and the edges of the platforms.

There are five sections, each with five fuel pods. The stages become progressively harder, until Jack meets Wilfred the hideous Yugg monster on section five!

The sounds used are simple but effective, and may be switched off at the start of each new game. The graphics are fair rather than excellent. The



movement can be less than smooth, but this fault is not serious. Colour has been used well and some of the monsters look really mean!

Controlling Jack is easy, using only three keys. 'Control' and 'A' govern

horizontal movement, while 'Return' fires the rockets on Jack's power pack.

You can begin a new game at any level, a good idea for all games. If you get tired of playing, Escape takes you back to the top-ten scoreboard.

*Jet-Power Jack* is great fun, addictive, quite frustrating at times and, best of all, good value for money.

**Stuart Menges**

## YOUR SEARCH

## THROUGH TIME

'Lords of Time', Level 9, BBC (32k), £9.90

LEVEL 9 – arguably the producer of the best adventure games in the UK – has done it again. *Lords of Time* is a sparkling addition to its stable of winners, with more than 200 beautifully described locations and a repertoire of witty ripostes to even the dumbest instruction.

The game's theme involves nine evil Timelords who have meddled with Earth's history so that they can rule eternally. Father Time recruits the player (that's you) to travel through time and put an end to their dastardly deeds by collecting nine 'symbolic objects' which, he assures you, can repair history. On the way there are, of course, plenty of valuable nick-knacks to be picked up, ensuring a comfortable retirement for the weary time-traveller.

The game is divided into nine time zones – nine separate adventures in different periods of the Earth's past and future – interlinked in that objects found in one zone are needed to solve puzzles in another.

There are some useful additional features – for instance, longer phrases can be entered, such as 'Give drink to bartender'. This makes the game more realistic and gets away from the endless repetition of 'Take' and 'Drop'. Also, if you want to know more about an object before you pick it up, you can examine it and get a more detailed description. This might range from the cryptic (Examine candle – 'wax') to the helpful (Examine suit of armour – 'Just your size!').

Full marks to Sue Gazzard for an ingenious and entertaining game design, and to Pete and Mike Austin for its excellent implementation. Response time is fast and – most important – you can restart the game without re-loading an initialisation data file (other game writers please note).

Oh well, back to the keyboard – yes, I confess, I haven't actually cracked *Lords of Time* yet! Now where did I leave the Galactic Groat? Was it on the ice-age glacier or in the Tudor hedge-maze?

**Mike Milne**

# Go hunting with **CAESAR THE CAT**

## MIRRORSOFT

### SOFTWARE FOR ALL THE FAMILY



To MIRRORSOFT, PO Box 50, Bromley, Kent BR2 9TT

Please send me the following (enter number required of each item in the space provided):

	Price	Spectrum 48K (01)	BBC B (03)	Electron (04)	CBM 64 (05)
Caesar the Cat (CC01)	£8.95				
Caesar the Cat (CC01)	£6.95				

I enclose a cheque/PO for £..... made payable to "Readers' Account: Mirror Group Newspapers Ltd". I understand that my remittance will be held on my behalf in the bank account named above until the goods are despatched.

Or please debit my ACCESS/BARCLAYCARD for the sum of

£..... card no

Signature..... AU1

Name.....

Address.....

Postcode.....

Offer applies to Great Britain and Eire only. Please allow up to 28 days for delivery in the UK. MIRRORSOFT is a registered trade mark of Mirror Group Newspapers Ltd. Co. Reg. No: 168660. Reg. Office: Holborn Circus, London EC1.



# What the competition hasn't been waiting for.

Latest version of Forth for the BBC (Is not rehased Forth 79 Code)

Unique Stack Display Utility



16k Eprom type 27128

Multi-tasking operating system for Real-Time use.

Here's the Forth Eprom for the BBC Micro that makes all others out of date.

It's Multi-Forth 83 from David Husband who has built his reputation for Quality Forth products with his ZX81-Forth ROM, Spectrum Forth-I/O Cartridge and now New Multi-Forth 83 for the BBC Micro. This is not rehased Forth 79 Code, but a completely new version of the Forth 83 Standard. It's unique in that it Multi-tasks, and therefore the user can have a number of Forth programs executing simultaneously and transparently of each other.

Multi-Forth 83 sits in the sideways ROM area of the BBC along with any other ROMs in use. It is compatible with the MOS, and specially vectored to enable a system to be reconfigured. It contains a Standard 6502 Assembler, a Standard Screen Editor, and a Unique Stack Display Utility.

With this Forth, David Husband has provided the BBC Micro with capabilities never before realised. And being 16K rather than 8K is twice the size of other versions. Multi-Forth 83 is supplied with an

extensive Manual (170 pages plus) and at £40+VAT it is superb value. Order it using the coupon adding £2.30 p&p (£5 for Europe, £10 outside) or if you want more information, tick that box instead. Either way, it will put you one step ahead of the competition.

Please send me Multi-Forth 83 for BBC Micro. £40+VAT. De-luxe System inc. Disc £80+VAT. Cheques to Skywave Software Readers' A/C (or enter Visa No.)

Name \_\_\_\_\_

Address \_\_\_\_\_

Post code \_\_\_\_\_

Send to Skywave Software, 73 Curzon Road, Bournemouth, BH1 4PW, Dorset, England. Tel: (0202) 302385

Please send me more information:

Multi-Forth 83

ZX81-Forth ROM

Spectrum Forth-I/O Cartridge

**Skywave SOFTWARE**

## MULTI-FORTH 83 FOR THE BBC MICRO

# HIGH QUALITY COMPUTER DESKS AT HIGHLY COMPETITIVE PRICES.

### THE ORGANISER DESK.

- Top shelf for monitor/printer.
- Large desk top area.
- Lower shelf for paper/book storage.
- Teak finish • On castors.
- Self assembly.
- Ample room in front of the shelf for you to sit comfortably.
- Assembled Dimensions: H.31" W.40¼" D.26"



Only **£59.95.**



### THE APOLLO RANGE OF BUSINESS DESKS.

- 10 models available to suit leading computer systems. • Immediate delivery.
- Sturdy steel underframes.
- Scratch resistant surfaces.
- Lockable castors. • Prices from **£100.**

All are on display in our showroom and are available from us or dealers throughout the U.K. All prices include VAT and delivery.

For further details contact us at:  
158 Camberwell Road, London SE5 0EE. Telephone: 01-701 8668.

**Opus.**  
Opus Supplies Ltd.

## PROFESSIONAL SOFTWARE FOR THE BBC MICRO

### EASIPILOT

EASIPILOT is a sophisticated AND user friendly graph package for the BBC Micro, placed 14th in the top 20 Educational packages by the leading Educational Computing Magazine. EASIPILOT has also come to be regarded as an 'outstanding business package' and 'excellent value for money'.

Note:- EASIPILOT 3 comes complete with the number charting program DATA PLOTTER with graph magnification, colour and moving average facilities. SUPERB VALUE AT £22.95.

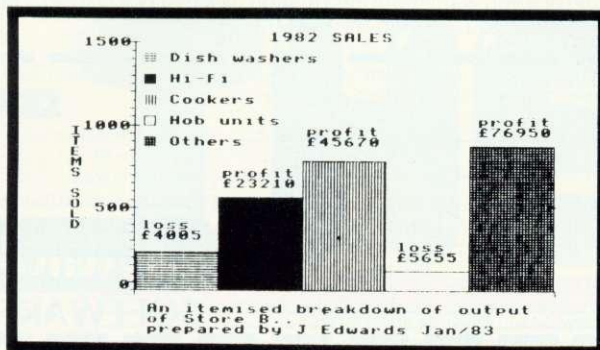

#### EASIPILOT FACILITIES

Line, Bar and Pie Charts  
Auto & Manual Scaling  
Grid & Scatter Options  
No of simultaneous graphs  
Overwrite memory  
Screensave facility  
Screendump facility  
Fixed description per graph (char's)  
Full plot and axis editing  
Save, Load & \*CAT facilities  
Single file selection  
Operating Manual (pages)

#### DISK CASSETTE

YES YES  
YES YES  
YES YES  
5 3  
YES NO  
YES YES  
YES YES  
up to 200 100  
YES YES  
YES YES  
YES NO  
52 52

All our programs will produce hard copy on the following printers:- EPSON (entire range), Shinwa CP80, Star DP 510, Seikosha (GP80A & GP100A). Share Analyser will produce reports on any BBC compatible printer.

PLEASE NOTE:- Our programs CANNOT BE OBTAINED FROM YOUR LOCAL DEALER so send for details NOW.

PROGRAM	PRICE
Data Plotter (cassette) . . Model B & Electron	£7.00
Data Plotter (disk) . . Model B	£8.00
Easiplot 1 (cassette) . . Model B & Electron	£15.95
Easiplot 2 (disk only) . . Model B	£19.95
Easiplot 3 (including Data Plotter-disk only)	£22.95
Share Analyser (cassette) . . Model B & Electron	£14.95
Share Analyser (disk only) . . Model B	£19.95

Disk orders . . please state 40 or 80 track (add £1 for 80 track and £1.50 for overseas orders). We will upgrade Easiplot 1 to Easiplot 2 for £7 (£10 to Easiplot 3).

Write for full details of all our programs or leave your name and address with our Answerphone service (Luton 33858). All programs are normally despatched within 24 hours.

Send cheque/P.O. etc to  
Synergy Software, 7 St Andrews Close, Slip End, Luton, LU1 4DE.

### SHARE ANALYSER

SHARE ANALYSER is a sophisticated portfolio reporting and share analysis package designed for the small investor. The disk version has a capacity of 20,000 SHARE PRICES and up to 320 buy/sell deals covering 20 share names. Share Analyser has facilities for profit flexing and multiple merging of graphs and a variety of selectable indicators. **SHARE ANALYSER IS A MUST FOR THE INVESTOR AT A BARGAIN PRICE.**

#### PROFIT STATEMENT

NAME BRITISH PETROLEUM		
DEALINGS		
Bought	Av Price	Cost
600	338	2028
Sold	Av Price	Income
300	426	1278
Held	Curr Price	Mkt Valn
300	438	1314
	Gross Profit	564
	Income	257
	Expenses	101
	Net Profit	720
	% Gain	= 36

#### SHARE ANALYSER FACILITIES

No of prices stored  
Max no' of Holdings  
Transactions per holding  
Range adjuster  
File Manager  
Printer Manager

#### DISK CASSETTE

20,000 Appx 1700  
20 20  
16 16  
YES NO  
YES NO  
YES NO

#### REPORTS PRODUCED:-

Portfolio Valuation	YES	YES
Portfolio Profit Analysis	YES	YES
Share Profit Analysis	YES	YES
Share Movement Analysis	YES	YES
Transaction Record Report	YES	NO
File Status Report	YES	NO

#### GRAPHICS FACILITIES:-

Magnification option	YES	YES
Grid	YES	YES
Autoscale	YES	YES
Screenwrite	YES	YES
Screendump	YES	YES

#### SELECTABLE GRAPHICAL INDICATORS:-

Lagged Moving Average	YES	YES
Centred Moving Average	YES	YES
Rise and fall indicator	YES	YES
Weekly/Daily Low indicator	YES	YES
Superimpose Facility	YES	YES

# IT'S FASTER VIA THE SILICON DRIVE

... says Malcolm  
Banthorpe

**Sideways RAM board (128k), Solidisk Technology, 17 Sweyne Avenue, South-end-on-Sea, Essex SS2 5JJ (0702) 354674, £139.95 (inc VAT)**

IN HIS review of the 16k version of Solidisk's sideways RAM system (February issue), Vincent Fojut talked of its exciting potential for expanding the BBC micro, and explained that the board itself could be expanded in two stages to 32k and 128k. This largest version can also be bought as a complete unit which offers significant additional facilities.

Here are my experiences with the 128k version.

As the previous review pointed out, inserting wire terminals into the CPU socket alongside the CPU pins seems a little crude, and for me this proved the most tricky part of the installation. With the 128k board another five connections have to be made to the 6522 VIA and another chip. However, at least the need for permanent modification to the circuit board is eliminated and the system has proved reliable.

Used straightforwardly, the 128k board gives eight paged blocks of RAM, each of 16k, into which can be loaded sideways ROM-type software – or you can assemble your own machine-code routines directly into this area, leaving the main memory free for Basic programs and screen memory.

What really distinguishes the 128k unit is that software is supplied that enables this extra memory to behave as a 'silicon disc'. In this mode, 100k is available. The software loads a modified copy of the DFS into sideways block 8. For this purpose you must have Acorn DFS 0.90 already installed in the machine and it can be assumed that other DFS systems will not be suitable. One 16k block (sideways location 15) is still available for sideways software.

The rest of the sideways RAM now behaves for most purposes as if it were a 100k disc drive – only faster. All the normal DFS commands are recognised and obeyed, the silicon disc appearing as drive 1. If you already have a drive 1, an alternative piece of software can be loaded to make the silicon appear as drive 4.

Three new DFS commands are incorporated into the modified DFS: \*FORM40 (or \*FORM80) formats 40 and 80 track discs; \*VERIFY, according to

the instructions, or \*VFY in the software as received, verifies either the silicon drive or a conventional floppy; and \*DCOPY copies the contents of the disc in drive 0 to drive 1 or vice versa. This last command behaves almost the same \*COPY \*.\* to copy all the files from one disc to another, except that if you try to copy from the silicon drive to an unformatted disc the new disc will automatically be formatted first.

\*DCOPY could be the most useful command for owners of a single conventional drive, as it enables backup copies to be made rapidly without the disc swapping normally required when using \*BACKUP or \*COPY \*.\* with a single drive. With the Solidisk board installed, one simply \*DCOPY's the floppy into the silicon disc in one operation and \*DCOPY's everything back onto a new disc in a second single operation.

The average file transfer speed is claimed to be 40k per second – up to 15 times the speed of a floppy. The speed is certainly apparent when loading program and data files, especially as no time is taken for the disc to get up to

still resident in sideways RAM, a large program could use data files on the Solidisk as an alternative to arrays without much loss of speed.

As well as the silicon disc program, other useful utilities were supplied on disc. Most of them involve the use of machine code routines, but in many instances source code is supplied. Solidisk Technology offers software updates at just £2 for a new disc.

*Menu* is a useful program to include on any floppy disc to be used alongside the Solidisk system. It displays the contents of all 16 potential sideways ROM/RAM locations, plus the catalogue of the floppy drive and the silicon disc (if the sideways RAM has previously been booted into this role). Any file shown can be loaded with a single keystroke.

Among the other utilities supplied:

*Sillexicon*, three programs which constitute a fast spelling checker for any text file on floppy disc. A 4.5k machine code program plus a dictionary file and a 'tree table' are loaded into the silicon drive. The dictionary initially holds 5000 words and may be extended by the user up to about 15,000 words.

Operation	Floppy disc	Solidisk
*LOAD 12.5k program	2.86 secs	0.24 secs
Open data file and store 1000 6-character strings	19.69	6.01
Open data file and read 1000 6-character strings	19.49	4.78
*LOAD mode 1 screen (20k)	3.24	0.32
Store 1000 bytes using BPUT	4.75	1.66
Read 1000 bytes using BGET	4.11	1.56
Load Wordwise file of 2250 words	29.5	6.8
*BACKUP floppy to Solidisk: 20.8 seconds		
*BACKUP Solidisk to floppy: 22.7 seconds		

**Table 1. How the Solidisk 128k board compares for speed with a 40-track floppy disc drive**

speed. Table 1 shows how the speed of the Solidisk system compared with my single-density 40-track floppy drive in a number of typical operations.

These timings include the time taken for the floppy to get up to speed and show that, while the speed difference is not always 'up to 15 times' as great, there's always an advantage.

The speed of storing single bytes using BPUT was also compared with the time taken for a Basic program to store 1000 bytes directly to the main memory. Here the time was 0.98 seconds for direct storage – just over half the time taken to store similar information on the Solidisk system. This indicates that, though it is not yet possible to run a Basic program while it is

*Word64*, a utility for creating Wordwise files up to 64k in length as opposed to the normal 24k limit. This is achieved by holding only a 16k 'window' to the complete text file in the main memory area, the rest being held on silicon disc.

*Buffer* appears on the disc but was not documented in the instructions. It turns out to be a print buffer that sends any text to be printed rapidly to the buffer first, releasing the computer for use while the printer is at work.

If you are using a single disc drive then the Solidisk 128k system is worth considering as an alternative to a second drive. Its price compares with that of a single 40-track drive and it offers a number of advantages.

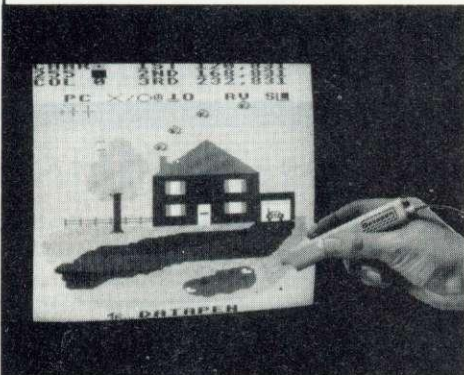

### BEEBPEN DRAWING PROGRAM

A comprehensive Mode 2 colour drawing program allowing plot commands, painting, circles, text, character defining, saving and loading to tape or disc, all to be selected and used with the lightpen.

PRICE £11.95 Introductory Offer £9.95

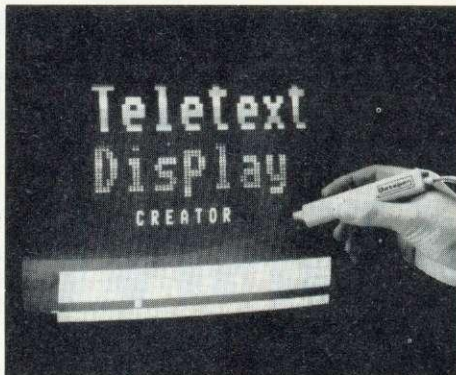

### TELETEXT DISPLAY CREATOR/EDITOR

Allows the busy programmer to quickly create Mode 7 colour graphics and test screens for combination into his or her own programs. Movable on screen menu allows use of complete screen for graphics. Full instructions and a discussion on teletext features are provided. PRICE £9.95 Introductory Offer £7.95



### BRITAIN

The first in a series of educational Geography and Geology programs. Britain comes complete with three sets of tests, and these may be very easily changed by adding DATA statements in the Basic program. Full instructions and grid map supplied.

PRICE £6.95 Introductory Offer £5.95

### SUPERIOR PERFORMANCE

- Intensive to ambient lighting
- Responds to different colours
- Program accessible LED lamp readout
- Switch for program control



### SUPERIOR PROGRAMS

- Tape storage of your work
- Good documentation
- User routines provided on tape and on printout

The Datapen Lightpen itself comes complete with handbook, software on tape including two drawing programs and a printed listing showing useful routines.

### PRICE £25.00

Two drawing programs, SKETCH and SHAPE-CREATE are included with the lightpen and the programs shown above may be ordered additionally, or separately as required.

All prices above include VAT, postage and packing.

Please send your cheque/P.O. to:-

Dept. 4, Datapen Microtechnology Ltd., Kingsclere Road, Overton, Hants. RG25 3JB

PERSONAL  
COMPUTER  
SOFTWARE

# proxima

Program features with  
**height**  
**italic**

**BIG Print**  
(c) Proxima Software  
very Tall text as well as normal text.

**FONTS**  
ONE FIVE  
THREE SEVEN  
FOUR EIGHT

**BEEB-TEXT**  
A sophisticated and unique machine-code program which allows virtually unlimited variation in the BBC's text display. The user has the option of varying character thickness, italic, style, height, width, colour combinations, etc. Up to 8 different fonts can be displayed in one page including shadowed and outlined types. Beeb-Text displays text in proportional spacing too however the user can also control character and line spacing independently.  
Disc £15.00

▲Prices are fully inclusive, no extra to pay.  
▲P&P on all orders is FREE!  
▲Please make cheques/P.O.'s payable to PROXIMA SOFTWARE.

**THINK BIG\***  
A highly effective machine-code program for displaying any dimension text. Can be incorporated into other programs.  
Cassette £5.95  
Disc £8.95

**PIXEL PACKAGE\***  
Two programs are supplied for designing single colour and multi-colour characters, inverted, rotated and duplicated. The programs even store the resulting data in program lines ready to be used.  
Cassette £7.95  
Disc £10.95

**DISC TOOLS**  
The complete utility disc for twin 80 track drive users and includes a 40/80 or 80/40 backing up facility.  
Disc £10.95

**ROBOBRAIN**  
Arcade fun. Disable the robot's positronic brain but watch out for its self defence.  
Cassette £7.95  
Disc £10.95

**TWO PLAYER GAMES\***  
Two 2-player games including 4Line and Frustration, joystick compatible.  
Cassette £6.95  
Disc £9.95

PROXIMA PERSONAL COMPUTER SOFTWARE, 1G10 1BT. Sparelease Hill, Loughton, Essex, IG10 1BT. Please specify 40 or 80 track or 3rd types when ordering discs.  
Our FREE program special offer continues. Contact us for details!



# TRIPLE TEST

## BUS PRICES

Acorn	£325.00
Cambridge Computer Consultants	£224.25
CST-Procyon	£385.00

*Including VAT, mains lead and cable for connection to the micro*

Paul Beverley and Nigel Eames try three IEEE488s

155

**T**HERE are a number of standardised methods of interfacing computers to other devices and one of the more versatile of these is the IEEE488 standard interface bus. Three companies, all based in Cambridge, produce one: Acorn, Cambridge Computer Consultants (now trading as Aries Computers) and CST-Procyon.

The IEEE488 interface bus was originally developed by Hewlett-Packard as a means of communication between 'intelligent' instruments. This first version, called the Hewlett-Packard Interface Bus (HPIB) or the General Purpose Interface Bus (GPIB) was standardised and its specification published in the IEEE488 Standard of 1975, revised in 1978. Up to 15 instruments may be connected to the bus at any one time, one or more of which can control the data transfers between the others. (The IEC625 Standard, another industry standard interface, is identical to the IEEE488 except for the type of connectors used.)

Typical applications include micro-controlled testing stations for testing production instruments or running a complete set of tests on the performance of a particular system (figure 1).

Measurements of quantities such as frequency response, rise time, phase shift and many others can be made automatically and limited only by the facilities available on the 'intelligent' test gear. The computer acts as the controller, issuing instructions over the bus for the transmission and reception of data and for the function control of the instruments—for example, frequency selection, range changing, disabling and enabling of front-panel controls and pen-up/pen-down instructions for plotters. In some circumstances it is necessary to synchronise signal generation and the collection of the resultant data, and this is taken care of by the controller or computer.

The bus has 24 lines—eight for data; eight for control (three for 'handshaking' and five for 'management'); and eight ground lines. The handshake lines are used by the controller and the

peripheral devices for controlling the transfer of data over the bus. A device, often called a 'listener', indicates its readiness to receive data by putting a logic 0 on the perversely named Not Ready For Data (NRFD) line, ie, if the line is low (= Not high) it is ready for data. The sending device, often called the 'talker', places the data on the bus and sets the Data Valid (DAV) line high. The listener signals its collection of the data by setting the Not Data Accepted (NDAC) line low, ie, active low.

The IEEE488 standard bus may be run at data rates of up to 1Mb/sec, which imposes stringent conditions on the lengths and types of cables used. The ground lines form twisted pairs with each of the control lines, minimising interference between these asynchronous lines. The bus is connected in parallel to every instrument in the system either in a linear manner, one after the other, or in radiating star arrangement. The connectors on the cables must, of course, be stackable. Cable lengths are limited to 2m per instrument, or 20m overall, whichever is the shorter.

The interface management lines which are used to control the flow of

data and commands over the bus and to reflect its status are as follows:

**ATN**—When the Attention line is high this is an indication by the controller that data on the bus is to be interpreted as a command and not as data. For example, this may be used to set up a device as a listener or to disable the front panel controls of the instrument.

**IFC**—Interface Clear. This line, which is active high, is an overall reset control line and all devices capable of responding will do so. It is analogous to the BREAK key on the BBC micro and should be used only upon initialisation of a system. Only the system controller can issue this command.

**REN**—Some instruments are capable of remote operation via the bus as well as from their front panel. The remote enable REN (active high) line is used to put such instruments into the remote controlled state when they have previously been set up to receive data or commands.

**SRQ**—Service Request. This is the line, or flag, used by the peripheral devices to request servicing in the event of an error condition or some circumstance beyond its control—eg, input signal out

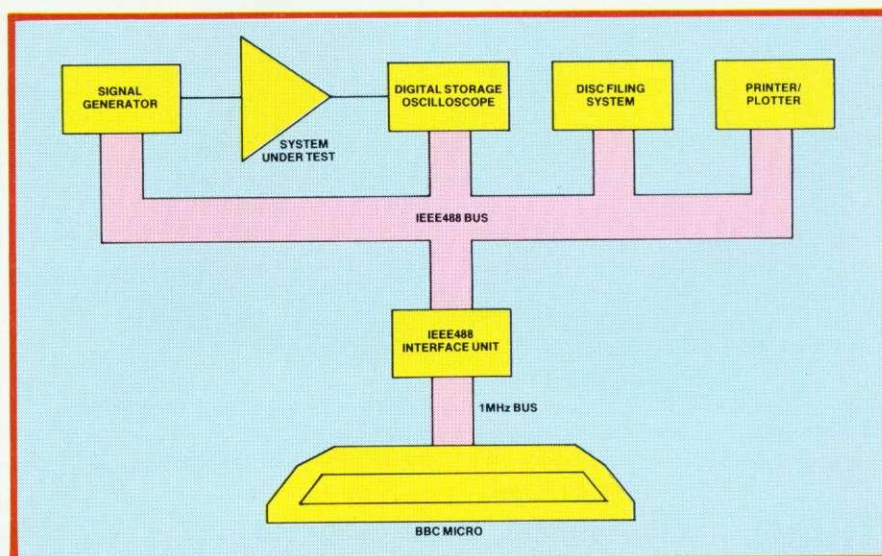

Figure 1. Typical IEEE test rig

# 'hands off the Ultradrive!'



At last a computer controlled storage device that will load a 16k program in under 15 seconds\* and doesn't use any of your computer's precious memory!

Each ULTRA DRIVE Micro cassette has an enormous 200k byte capacity\*.

The ULTRA DRIVE comes complete with all necessary interfaces, its own sophisticated filing system, and a utility cassette.

All this for only  
**£79.95 inc. VAT**  
 NO HIDDEN EXTRAS

This incredible machine  
 is available for  
 DRAGON ELECTRON BBC  
 NASCOM ORIC TANDY  
 COMMODORE



\*For the Dragon computer. Specifications may vary slightly for other computers.

10 day money back guarantee  
 Purchase price will be  
 refunded if not delighted

**IKON**

**COMPUTER PRODUCTS**

IKON COMPUTER PRODUCTS, DEPT. E, KILN LAKE, LAUGHARNE,  
 DYFED SA33 4QE (Tel. 099 421 515)

To: IKON COMPUTER PRODUCTS, DEPT. E, KILN LAKE, LAUGHARNE, DYFED SA33 4QE (Tel. 099 421 515)  
 Please send me \_\_\_\_\_ ULTRA DRIVE(s) for the  
 Data certified cassettes @ £4.03 each.  
 Cleaning cassettes @ £4.60 each.  
 Please charge my Access/Visa card no \_\_\_\_\_ I enclose cheque/P.O. value £ \_\_\_\_\_  
 Name: \_\_\_\_\_  
 Address: \_\_\_\_\_  
 Signature: \_\_\_\_\_  
 (Please allow 28 days for delivery. Remittances  
 despatched)  
 \*For the Dragon computer.  
 Specifications may vary slightly for  
 other computers.

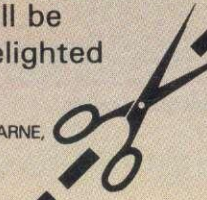

of range, data buffer full or invalid command. It does not affect the current operation on the bus and it is up to the controller to take the necessary action. **EOI**—End Or Identify. The data transmitting device (which may or may not be the controller) drives this line high, simultaneously transmitting the last byte of data.

The data is transmitted over the bus as strings of ASCII codes. The strings are sent one byte at a time and 'handshaking' is used for each byte, thereby giving very reliable (and fast) transfer of data. Using ASCII encoded data overcomes the problem of different instruments or systems representing numbers and control codes in different ways. ASCII codes use only seven bits out of the eight in each byte and so in some systems the eighth bit is used for parity checking. It is sometimes necessary to send the full eight bits of each byte and this may be done by transferring each byte separately.

The full complement of functions described by the standard is rarely implemented on any one instrument simply because they are not all needed and so subsets are implemented as required. The standard allows for more than one controller to be connected to the bus and provides facilities for transferring control from one to the other. However some systems, such as Pet and Apple, implement a subset that allows only one controller, and in the case of Pet computers the device addresses are fixed as well.

Each device connected to the bus must have a unique address, which may be in the range 0 to 30. This allows a range of instruments to have their device address preset so that any combination of them may be used on the bus without having to change device addresses every time the combination of instruments is changed. The address is usually preset on each instrument by a switch on the back panel. In some instruments it is preset by the manufacturer and may be altered by changing links on the circuit board; in others it is fixed. Occasionally, it may be set as required through the software.

This address is called the primary address of the device. Secondary addresses are those within a particular instrument that allow the controller to select the required function. A digital multimeter, for example, would have several secondary addresses for the selection of DC, AC, voltage, current, resistance etc.

To make an objective assessment of the systems from Acorn, Cambridge Computer and CST-Procyon the relatively simple task of sending a data array from the computer memory to a

printer via the interface was programmed for each of the three units. Data sent was the ASCII encoded listing of the program required to effect the data transfer. Two versions of each program were run, first using data strings and secondly single bytes. The program listings are shown in listings 1 to 6 (yellow pages xi and xii) with comments on those instructions peculiar to each interface. The programs were written at the highest level available, ie, Basic, as this is easiest to read to compare. For high-speed data transfers, lower level routines should be used where provided.

The Acorn unit is externally attractive, being housed in a moulded case that matches the colour and profile of



**The Cambridge Computer Consultants (Aries Computers) unit has three useful LEDs**



**Software for the CST-Procyon interface is in an EPROM**

the BBC computer. Connection to the computer is via a ribbon cable terminated with an ID connector for direct connection to the 1MHz bus. The 1MHz bus connector is stackable at the interface end, thus allowing other interfaces or systems access to the 1MHz bus. The unit contains terminating resistors for the 1MHz bus which may be easily unplugged from their sockets if the unit is not the last device to be connected to the computer. The power supply is on the same PCB as the rest of the circuit, except for the mains transformer, and the unit comes with a fitted mains cable with moulded integral 13 amp plug.

The software to run the interface is in an EPROM which plugs into one of the vacant ROM sockets inside the BBC computer. The manual has comprehensive instructions for fitting the EPROM and for making the necessary link changes if your machine is pre OS 1.0 (Acorn says it will provide and fit a 1.2 operating system ROM free if you still have the 0.1 operating system ROM).

The computer treats the interface as a filing system and selects it with the \*IEEE command. Immediately following the first use of \*IEEE you must carry out four instructions. These are: open the command and data channels; set the device address of the computer; and clear the interface. Channels to peripheral devices must be created using the command OPENIN (line 90, listing 1) and set up to LISTEN (line 100) or to TALK before data transfers can take place (line 130). Up to 14 channels can be open at any one time.

If the data is to be transferred byte by byte instead of as a string, the interface must be informed and told the number of bytes to be transmitted (line 110, listing 2). BPUT#<channel> (data byte) is used to output the data rather than the PRINT#<channel> (data string) instruction used otherwise. It is good housekeeping practice to close channels when they are no longer required, as the channels remain open even if a different filing system is selected. Channels are closed using the CLOSE#<channel> instruction or the CLOSE#0 instruction which closes all channels except the command and data channels.

Listings 1 and 2 imply that the Acorn unit requires more programming effort than the other two and this is probably true. However, they also disguise its underlying versatility. It is possible to allow one device to 'talk' to others without involving the computer in data transfer, leaving it free for other tasks. Control may be passed to another controller connected to the bus and requested back again, and the system may be used with any language running on the computer that allows the use of a filing system. The language structure used in the instructions makes it easy for the programmer to keep track of what is going on.

The manual is not for the uninitiated. It's brevity is chilling. However, those familiar with the IEEE interface will probably find most of what they require, the documentation outlining the commands in Basic and the operating system calls that are used by the interface.

Cambridge Computer Consultants' unit comes in a compact metal case with three LEDs on the front panel that indicate the status of the ATN line, whether the interface is addressed to TALK and whether data is being transferred—a useful aid when fault-finding an inoperative system. The back panel has the device socket and six miniature DIL switches, five to set the device address of the interface and one to set the interface as the 'master' controller or the 'slave' controller. Unfortunately, in the Off position the switches actually

# More drive from Broadway.

## DISC DRIVES FOR THE BBC MICROCOMPUTER



The Broadway Drive, already in use all over the world by many leading Colleges and Universities, is now available at more competitive prices than ever.

All drives include the Broadway publication "Making the most of your BBC Disc System" and accompanying utilities disc (available separately at £30. per set), and offer the back-up that has made Broadway one of the principal Acorn and BBC dealers.

All 80 track drives are 40/80 compatible, and the unique Broadway 500 will write 80 to 40 tracks. Already in use by many leading software houses.

### CHOICE OF 5 MODELS

- \* 100K SINGLE 40 TRACK
- \* 200K DOUBLE 40 TRACK
- \* 400K SINGLE 40/80 TRACK SWITCHABLE
- \* 800K DOUBLE 40/80 TRACK SWITCHABLE
- \* NEW 100K 40 TRACK PLUS 400K 40/80 TRACK SWITCHABLE

Ready to use, includes: Manual, Format Disc & Leads



# Broadway

ELECTRONICS Aston Road, Bedford, Beds MK42 0LJ. Telephone: (0234) 58303. Part of the Mushroom Computer group of Companies.





touched the side of the slot in the case and were difficult to move back to On.

Again, the unit's power supply is on the same board, except for the mains transformer. The mains connections to the transformer tags were covered with a piece of insulating tape. Connection to the computer is via a ribbon cable terminated with a non-stackable ID connector for direct connection to the 1MHz bus.

The software is supplied on disc or cassette and consists of a library of procedures and functions in Basic that are loaded into memory above the user program. The library line numbers start at 30000 and the library itself occupies just under 1.8k. A well-documented source program describes the purpose of the functions and procedures.

The CCC unit is used by calling procedures to perform the required tasks. Before any data transfers are attempted, the bus must be initialised by calling PROCIEINIT <address>. The argument for this command is the base address of the memory mapped Input/Output, &FC20. To set the interface up as a TALKer the PROCIEWRIT-<LISTENer device address> instruction is used (line 60, listing 3). The device address used here must contain the device primary address and, if there is one, the secondary address. If there is no secondary address '-1' must be inserted instead. Data can then be sent either as an array, in strings or byte by byte (line 70, listing 3 and line 80, listing 4).

If the data is to be sent to more than one listener, each listener must be enabled separately by calling a procedure PROCIELA <listener address>. This is necessary where device events need to be synchronised.

This unit required four instructions, including the housekeeping, to perform the simple program listing task, which compares favourably with the Acorn interface. But for a more complex IEEE488 link-up with several devices connected to the bus the Acorn unit is preferable, with its greater range of instructions available.

The manual gives a good introduction to the IEEE488 standard and describes in some detail most of, but not all, the procedures and functions in the software. The documentation is, however, inadequate for anything other than simple data transfers. The means of implementing such commands as Local Lockout, Selected Device Clear and a few others is not described at all. Irritatingly, the user is referred to the Texas Instruments data sheet for the TMS 9914 IEEE488 controller chip to find the necessary information.

Details of various options are given

in the manual, as are other technical details of internal modifications, including details of operation under interrupt.

The CST-Procyon unit is housed in a smart anodised aluminium case with the 1MHz bus and IEEE488 bus connectors on the back panel, which also contains the mains socket. The front panel has three LEDs for Data In, Data Out and Bus Active. The unit has an on-board power supply, the mains transformer also being mounted on the board.

The mains connections to the transformer are close to the edge of the board but are not insulated.

The software for this unit is in an EPROM, which fits into one of the



**Christopher Turner, head of Acorn's IEEE interface team, demonstrates the cosmetically matching Acorn bus unit**

vacant ROM slots on board the computer. The manual gives explicit fitting instructions.

It is obvious from the listings that this unit requires very little programming to output an array of data from memory—just two instructions, in fact. The interface is also treated as a filing system, as was the Acorn interface, and is also called by \*IEEE. Using the command \*IEEE automatically initialises the interface. Opening and closing of data channels is also automatic and is performed in the execution of the PRINT#<channel number> or INPUT-#<channel number> instructions. Thus only one instruction is required to output the data to the required channel. If a device has a secondary address, or more than one channel is listening you have to add a further instruction; a channel must be opened (with OPENIN) stating the primary and secondary addresses of all devices required.

The documentation for this unit is excellent and complete, covering not only high-level control of the bus in Basic but also in the lower level star commands, which use the IEEE standard mnemonics, and the BBC's operating system calls. Of the three, the CST-Procyon manual was the only one to specify the maximum data transfer rate, quoted as 50k/sec.

All three units have been manufac-

tured to a high standard and are mechanically robust, giving confidence in their long-term reliability.

For simple system configurations—for example, one talker and one listener—the CCC unit is ideal. It is easy to program at this level, does not involve fitting a ROM inside the computer and is relatively inexpensive. The unit is now marketed by the renamed company (Aries Computers) with the model name Aries-B488 and a number of improvements have been incorporated since the model was received for review.

The DIL switches on the back panel have now been removed and replaced by software programmable latches; the initialisation routine now includes the IEEE device address of the interface; the unit allows direct device-to-device communication and the software includes a simple means of placing numerical data that has been received in string format into arrays in the BBC micro.

The Acorn unit has a very full implementation of the standard and is therefore well suited to systems involving several instruments. Programming for multiple devices is no more difficult than it is for a single device.

The CST-Procyon interface has the fullest implementation of the standard, as it is possible to use this unit either as a controller or as a device and to change between the two functions. In controller mode it may be the overall system controller or a slave controller. In device mode it behaves as a device controlled by the current controller, which enables any machine or computer with an IEEE488 interface to control the BBC micro remotely.

Control via the interface is achieved using secondary addresses to give access to the operating system calls of the BBC. Specifically, these are the IEEE filing system, the OSCLI, OSBYTE, OSWORD, OSWRCH and OSRDCH routines.

CST-Procyon also offers a CBM filing system ROM to enable the Commodore peripherals to be used with the BBC micro and a set of libraries to support the use of the interface from most of the languages available on the Torch and Acorn Z80 second processors. Also available is an IEEE bus analyser ROM for diagnostic testing of other IEEE hardware.

There is a one-year warranty with guaranteed replacement of a faulty unit by the next working day.

Which one is the best buy? Well, it depends on what application you have in mind, and what facilities you therefore require. It would be fair to say that, with all three units, you get what you pay for.

# SYSTEM SOFTWARE

## •ROMs FOR THE BBC MICROCOMPUTER•

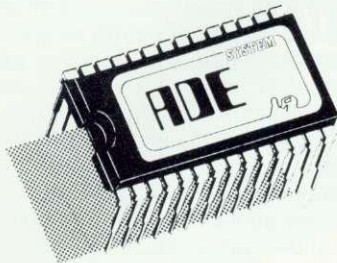

The complete program development package for assembly language programmers. ADE is the de facto industry standard for professional software writers using the BBC microcomputer. The 16k ROM contains a full 6502 MACRO assembler; a dynamic text editor; a front panel debugging monitor and disassembler. ADE comes complete with a 160 page comprehensive reference manual and a utility/macro library disc. ADE can also be used with tape based machines.

The ASSEMBLER features macros with library facilities; nestable conditional assembly; flexible listing options (with or without macro expansion); hex, decimal, binary and ASCII data formats; dummy section; full range of arithmetic and logical operators; symbol table sort and dump; file chaining and 29 powerful pseudo ops. Source and object files are kept on disc so there is no limit on program size or location.

The EDITOR is designed with the programmer in mind for writing both programs and documentation. The editor includes a very powerful command language (including macros) that enables much editing to be done on a semi-automatic basis. It features full screen editing and deferred edit modes; no limit to document size; edit with backup facilities and a versatile text formatter.

The DEBUGGER is instantly accessible for inspecting, modifying and disassembling machine code programs. Features include full 64 byte display in hex, ASCII and disassembled format; registers; stack; single step; breakpoints; memory search and much more.

**Price £60 inc vat.** Please specify 40 or 80T utility disc.

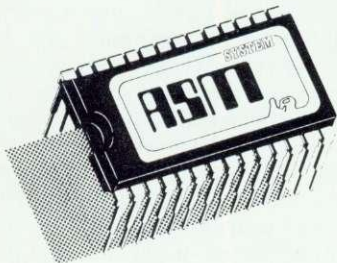

ASM provides all the superb features of the ADE macro assembler on its own ROM.

The program source file may be written using any editor (even Wordwise or View!). Complete with reference manual and utility/macro library disc. Use the assembler that professional software writers use.

**Price £35 inc vat.** Please specify 40 or 80T utility disc.

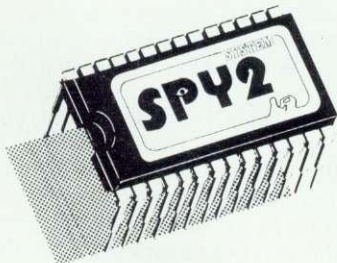

SPY2 is a front panel debugging monitor, disassembler and disc utility ROM. SPY2 is instantly accessible to the programmer for inspecting, modifying, debugging and disassembling machine code programs. SPY2 also features a relocater and program trace facilities. SPY2 will access any ROM either in the sideways ROM sockets or on an extension board. ROM memory may be displayed, single-stepped through or disassembled.

SPY2 includes a set of powerful disc recovery commands for interrogating, editing and retrieving data stored on a floppy disc. SPY2 also includes a disc formatter as well as a non-destructive single track reformatter.

In all SPY2 has a comprehensive set of 23 utility commands. These are supported by an excellent Reference Manual.

The SPY2 front panel encompasses all the superb, easy-to-use facilities of the renowned SPY debugging monitor PLUS additional commands for toggling and finding breakpoints; relocating machine code programs; single stepping through subroutines in one go and facilities for accessing the front panel from programs in RAM or ROM with breakpoints, OSBYTE or CTR-F.

SPY2 features a versatile disassembler with hex dump, full and intelligent disassembly. This identifies data areas in the program; these being displayed as a hex/ASCII dump. Operating system calls are labelled creating very readable code. The powerful trace facilities enable program instructions and register contents to be traced to printer whilst the program is running. Indispensable for graphics programs as they can be stepped through whilst observing the effects on the screen.

SPY2 features a disc sector editor displaying the contents of a whole sector; disc search facilities for finding byte patterns or strings and free disc space. Files may be recovered by creating a directory entry with all the data concerning the deleted file. Directory entries can be easily amended using the \*AMEND command. The \*FORMAT command formats discs with any number of tracks. A verify command checks discs. The \*REFORMAT command is extremely useful for recovering information from a bad track, reformatting it and restoring the data. Commands are included for loading files at 1900 and automatically downloading (and running) them.

The most comprehensive of all debugging/disc utility ROMs.

**Price £30 inc vat.**

# SYSTEM

Dept. A 12 Collegiate Crescent, Sheffield S10 2BA





# SLOGGER SOFTWARE

MACHINE CODE GAMES FOR BBC 'B', ELECTRON, SPECTRUM 16/48K

## A MAZE IN SPACE

Use Joysticks or Keyboards to navigate your Starship to the planet surface and then into the maze below. Having been told in which section of the maze your target is hidden, your objective is to seek out and destroy it to complete a mission. Beware of the numerous alien defence systems. Two levels of difficulty! Horizontal and diagonal scrolling! How many missions can you complete?

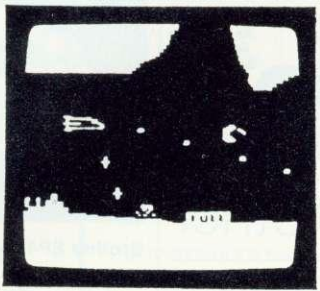

Available now	Cassette	Disc
BBC 'B'	£9.95	£11.95
Special Offer		
Dogfight and A Maze In Space together		
Cassette - £14.95	Disc - £16.95	

Please state 40 or 80 Track if disc

## DOGFIGHT

Still undoubtedly the most exciting 2-player game available. The objective is to fire sufficient shots into your enemy aircraft to force it to explode. Eight levels of difficulty. Sun, moving cloud, lightning, ground all provide real combat environment. Can you beat your friends?

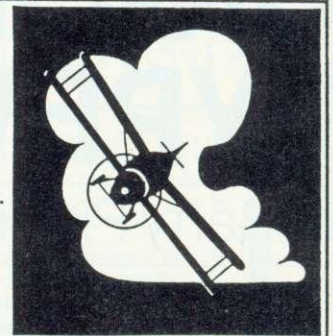

Available now	Cassette	Disc
BBC 'B'	£9.95	£11.95
Electron	£7.95	n/a
Spectrum	£5.50	n/a

### SLOGGER SOFTWARE

215 BEACON ROAD  
CHATHAM, KENT

Tel: (0634) 811634

All prices include VAT and postage



**NEW**

NOW AVAILABLE FOR THE

**electron**

**THE SIR COMPUTERS  
PRINTER/SWITCHED  
JOYSTICK INTERFACE**

**ONLY  
£44.95**



#### COMPLETE JOYSTICK & PRINTER FEATURES INCLUDE:

##### JOYSTICK FACILITIES:

- ★ Provides connections for two standard Atari-type joysticks, allowing the use of two-player games.
- ★ Immediately compatible with all games offering a joystick option.
- ★ Extra commands allow joysticks to be defined as any combination of keys, allowing all keyboard-operated games to be used with joysticks.
- ★ Joysticks may be read directly from BASIC using the ADVAL(n) function.

##### PRINTER FACILITIES:

- ★ Provides connections for a standard Centronics-type printer.
- ★ Allows use of all BBC Microcomputer printer control commands.
- ★ Special command enables a graphics screen to be copied to any Epson dot-matrix printer.

##### ADDITIONAL SPECIFICATIONS:

- ★ Only Acorn-approved memory locations are used, ensuring complete compatibility with any future devices (sideways ROM/RAM, sound expansion, speech synthesizer, disc system etc.).
- ★ All operating software is held within a paged ROM and is available for use from the moment the computer is switched on. THERE IS NO NEED TO LOAD ANY ADDITIONAL SOFTWARE FROM CASSETTE.
- ★ Housed in a sturdy plastic case.
- ★ Full twelve month guarantee.
- ★ Available direct from SIR COMPUTERS for only **£44.95** (inc. VAT).  
POSTAGE & PACKAGING FREE. Please allow 28 days for delivery.

#### SIR COMPUTERS - 1st for electron support

All our prices are inclusive of VAT and postage/packaging.

We also stock a complete range of printers, monitors, disc drives and software - with many hard-to-beat prices. Please telephone us for details.

Access/Barclaycard Telephone orders welcome.

SIR COMPUTERS Ltd

91 WHITCHURCH ROAD, CARDIFF CF4 3JP Telephone: CARDIFF (0222) 621813

#### Also Available for the ELECTRON the SIR ADC/PRINTER INTERFACE

NOT JUST ANOTHER JOYSTICK PORT - FULL ANALOGUE-TO-DIGITAL CONVERTER

provides fully proportional control, essential for use with graphics packages, digitizers, etc; ideal for scientific & educational applications; usable with a wide variety of BBC Micro-compatible analogue and switched Joysticks/Paddles.

CENTRONICS PRINTER INTERFACE - allows use of a wide variety of parallel printers including entire Epson range; complete firmware support included.

HIGH-QUALITY MOULDED CASE - attractively styled plastic unit bolts securely to the back of the computer.

EASY TO FIT - no soldering, simply plugs straight into computer's rear edge-connector and is held in place by twin bolts; edge-connector on back of unit provides for further modular expansion if necessary.

#### THE SIR ELECTRON PRINTER/ADC INTERFACE £65.95 the SIR ROM/RAM EXPANSION BOARD

Provides 12 extra sockets which support a variety of ROM and RAM configurations up to a max of 192K for ROM and 16K for RAM.

ROM and RAM is normally paged in 16K blocks but is easily switchable to 2K, 4K or 8K blocks.

Price: £59.95

Easy to install - just plugs in.

Professional styled casing bolts to rear of computer.

Fully buffered design.

Permits use of most BBC ROM-based software including utility ROMs, word-processors & languages.

# PIXELS ON PAPER

```
!"#$%&'()*+,-./0123456789:;<=>?@ABCDEFGHIJKLMN0PQRSTUVWXYZ[\]^_`abcdefghijklmnopqrstuvwxyz{|}~
PQRSTUVWXYZ{|}~"
```

The character set was in normal mode.  
The remaining Printing is in BOLD mode, which uses more ink, but is necessary for visibility.

First the 00o - 111 test. These characters are ugly but distinguishable.

Now to demonstrate the colour changes possible.

Underlining too and in colour.

Enlarged in colour and reversed.

TAB function:  
12345678901234567890123456789012345678901234567890123456789  
                  ^P0S20    ^P0S30                    ^P0S50

## George Hill finds a perfect colour match for the Beeb

**Canon PJ1080A ink-jet colour printer, £433+VAT (review model supplied by Microperipherals)**

THE CANON PJ1080A, one of a new generation of moderately priced colour printers, works on the ink-jet principle, which means that anything you can do on the screen you can do on the printer—bar charts, pie charts, colour graphs, screen dumps, coloured text. The real joy of the system is that it uses the same numbers to represent the colours as the Beeb does. This makes possible precise screen printing (I will explain how this is accomplished later).

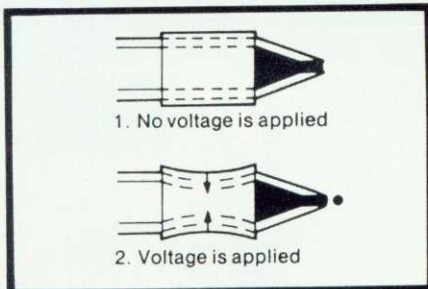

Figure 1.

The PJ1080A (not to be confused with the PW1080A dot matrix printer reviewed last month) uses the ink-jet principle in the 'drop on demand' form. That is to say, small drops of ink are expelled at high speed from the print-head by an electrically induced compression (figure 1). The drops are ejected from four nozzles for the four coloured inks, and the compressions timed to cause the required drop to hit the paper at the right instant.

This form of ink-jet technology produces a lower resolution than the other ink-jet method, involving charged droplets of ink in a directing field, the PJ1080A's being approximately equal to that of a conventional dot matrix printer (560 dots per line, non-overlapping).

To understand how the printer can so closely mimic what is displayed on the screen we need to consider the theories behind producing colour images.

Red, green and blue are the primary colours for transmitted light, and they can be mixed in any proportions to make the other colours—yellow, magenta and cyan. This is the basis on which the RGB television system works.

The situation is exactly reversed, however, when you are mixing coloured pigments, because the colours are now reflecting rather than emitting light. The primary colours here are the complementary colours yellow, magenta and cyan, which can be mixed to make red, green and blue. It follows, therefore, that there's a simple mathematical relationship between the two systems for mixing primary colours to create their complementary colours.

Actually, the Canon has four different coloured inks: yellow, magenta, cyan and black. Although black can be achieved by mixing the other three colours, the availability of black avoids the need to overprint three times—which carries the risk of smudging—and allows the printer to be used in normal printing mode. It also makes it possible to switch between black and white backgrounds, even while colour printing.

There are a few minor problems with this technology—the blue comes out rather purple and the other colours a trifle pale, but the Canon's overall results are startling.

What of the Canon's text? Well, it is barely tolerable. The style is ugly, being based on a 6×8 matrix with no descenders. The g is so bad that the manual mis-prints magenta as mazenta to avoid the embarrassment of showing it off in purple. The most peculiar thing is the O, which is really

an upside-down Q. This distinguishes it from the 0 but produces very peculiar-looking text.

The printer can print in bold mode (ie, deeper colours, using two drops of ink instead of one), enlarged mode, and of course in colour. It can print in any colour with any other colour as background and all is under software (ESCAPE sequence) control. The main features can be preset on easily accessed DIP switches.

Print speed is quoted as 37 characters per second, which boils down to a benchmark (actual printing speed in normal use) of 30.5cps in normal mode and 16.2cps in bold mode if you test it against program 5 (see page xiv). To use the program a stopwatch (not the TIME function on the Beeb) should be set to time the interval between first carriage movement and the appearance of the last character. Speed in characters per second is 2000/time\_taken.

The biggest disadvantage of the PJ1080A is the paper-handling. This Canon will cope only with friction feed paper of a maximum width of 216mm (8½in), which restricts it to roll paper or A4 sized cut sheets. You can't use fan-fold paper—it's too wide to feed in. Nevertheless, the roll-holding arrangements, as with all the other hardware features, are neat, well thought out and well engineered.

The manual for the PW1080A dot matrix printer was the best I have seen. This one is produced along the same lines, but it is so verbose and repetitious that it is difficult to see the wood for the trees. It is, however, full of programs, all in LPRINT terms.

To summarise its attributes, the PJ1080A colour printer is the greatest thing since sliced bread for graphics, adequate but slow for program listings, but a complete non-starter for word-processing.

# Reliable Original Microcomputer Software



Available from all good BBC Computer Dealers.  
Available by Mail Order from Computer Concepts, 16 Wayside, Chipperfield, Herts WD4 95J.  
Or by 'phoning with your credit card number on (09277) 69727.



# A DUMP IN ITS TRUE COLOURS

See your way clear to accurate dumps with George Hill's routines

165

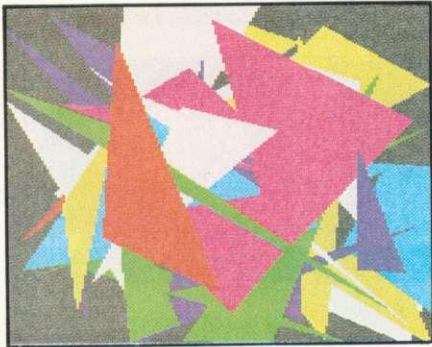

IT IS worth trying to mimic the BBC Micro's screen precisely in your printout, instead of being satisfied with a mere reasonable representation. But how do you produce a dump for a genuine colour printer? To do this we must first understand the organisation of BBC colour graphics.

The colour system on the Beeb is remarkably simple. Three bits represent any of the colours from 0 to 7:

Bit 0 (least significant) represents the RED component  
 Bit 1 represents the GREEN component  
 Bit 2 (most significant) represents the BLUE component

In binary terms:-

001 colour 1 is RED  
 010 2 is GREEN  
 011 3 is red and green mixed, giving YELLOW  
 100 4 is BLUE  
 101 5 is blue and red mixed, giving MAGENTA  
 110 6 is blue and green mixed, giving CYAN  
 111 7 is red, green and blue mixed, giving WHITE

Add a fourth bit and any of the above colours can be made to flash. This is done by subtracting them from 7 at a regular interval (using the EOR instruction), so colour 5 flashes with 2, 3 with 4 and so on.

How does the computer manage in modes other than mode 2, where only

two or four colours are available? The answer is by 'mapping'.

Let's look at mode 1 as an example. The GCOL command can have as its second argument the numbers 0, 1, 2 or 3 for foreground colour. These numbers correspond to the colours black, red, yellow and white. Thus the 'logical' colour is 0, 1, 2 or 3, but the 'physical' colour is 0, 1, 3 or 7. This relationship between logical and physical colour is accomplished by using a 'palette'. Thus when a mode 1 GCOL 0, 2 is encountered the micro consults a table (such as table 1 overleaf) to discover that logical colour 2 is actually physical colour 3, and so it plots yellow rather than green.

A copy of this table is located in normal RAM, at addresses &36F to &37E. It can be read by an OSWORD call, and written to by VDU19, etc, or via OSBYTE (\*FX155) or OSWORD.

The use of VDU19 (which writes to the palette) is exhaustively covered in vari-

ous places, including the *User Guide*. Its OSWORD and OSBYTE equivalents offer few advantages and are best avoided by the amateur. The technique by which you can read the palette is less well known, but it offers a powerful method of adjusting screen dump programs to read the actual colour physically displayed, as opposed to the logical colour, which is determined by the POINT function and its OSWORD equivalent (called with A% = 9).

The procedure to read the palette is:

1. Read the logical colour using OSWORD with the accumulator set to 9.
2. Use the value found by step 1, and pass it to OSWORD with the accumulator set to 11 (&B). This will read the palette, and puts the physical colour in the next byte, followed by the three trailing zeros used by VDU19 and destined for 'future expansion' - whatever form that may take.

To do it we need to set aside a block of



# Now YOU can go for gold ...with the



Fancy pitting yourself against the world's best at this summer's Olympics?

You can do so without going anywhere near Los Angeles — with the most challenging package of programs of 1984.

MICRO OLYMPICS is more than a game. It's a brilliantly written collection of ELEVEN track and field events.

And because we know we're going to sell many thousands of them we've brought the price right down — to just £5.95.

Ever imagined yourself as another Seb Coe? Then try to run against the world record holder at 1500 metres. And if that distance is too much for you then there's always the 100, 200, 400 and 800 metres to have a go at.

Not much good at running? Don't worry, MICRO OLYMPICS has many more challenges for you. Why not try your skill at the high jump or the long jump?

And if you can't beat the computer at running or jumping then you can always throw things around in frustration! The trouble is that it's just as hard to be a champion at the discus, the hammer or the javelin.

And the pole vault takes the event to new heights!

Yes, it's fast, furious fun, pitting yourself against the world's best times and distances on your micro.

You may not be another Steve Ovett or Alan Wells, but with practice you COULD become the Micro Olympics Champion!



*This is a special joint offer from  
The Micro User and Electron User*

**Play Micro Olympics  
— and let your fingers  
do the running!**

**Send for it today**

Please send me \_\_\_\_\_ copy/copies of  
Micro Olympics

I enclose cheque made payable to  
Database Publications Ltd.  
for £ \_\_\_\_\_

I wish to pay by

Access  Visa No. \_\_\_\_\_ Expiry date \_\_\_\_\_

Signed \_\_\_\_\_

Name \_\_\_\_\_

Address \_\_\_\_\_

- |  |       |
|--|-------|
| <input type="checkbox"/> BBC 'B' cassette  | £5.95 |
| <input type="checkbox"/> Electron cassette | £5.95 |
| <input type="checkbox"/> BBC 40-track disc | £7.95 |
| <input type="checkbox"/> BBC 80-track disc | £7.95 |

*Please tick box*

Post to: Micro Olympics offer, Database Publications,  
68 Chester Road, Hazel Grove, Stockport SK7 5NY.



```

DIM block 8      :REM reserve 9 bytes
block!0=X_coord :REM insert X
block!2=Y_coord  :REM insert Y

A%=9
X%=block MOD 256
Y%=block DIV 256
CALL &FFF1      :REM OSWORD

A%=11
X%=(block+5) MOD 256
Y%=(block+5) DIV 256
CALL &FFF1

on exit from the procedure
logical_colour=block?5
physical_colour=block?6
    
```

Listing 1.

memory. This can be at an absolute address that you are sure is free (eg, &B00, &C00, &80, etc) or a block reserved by a DIM statement. The latter is the preferred method if you want to incorporate the procedure into a Basic program. The length of the block is nine bytes (five bytes for Osword 9, plus four for the physical colour and three trailing zeros).

First set the X and Y registers (or X% and Y%) to point to this block of memory. The X and Y co-ordinates of the point to be read are placed in the first four bytes of the block. Now set A to 9, CALL OSWORD, and the logical colour is deposited in the fifth byte.

Reset the X and Y registers to point to the fifth byte of the block (where the logical colour is), set A to 11 (&B), and CALL OSWORD again. The physical colour is deposited in the sixth byte of the block, followed by three zeros in the seventh to ninth bytes of the block.

The Basic version would look like listing 1.

Translated into assembly language it looks like listing 2.

On exit the logical colour is in block + 5, and the physical in block + 6.

This is much simplified in actual programs by the use of labels, and the internal calculation of Xlo, Xhi and so on, which do not need re-setting on every entry.

This gives rise to two programs. The first (listing 3, page xiii), a hybrid Basic/ assembler program, is a 'universal' pattern dump for all graphics modes, using the ESCape L (double-density graphics) sequence available on many Epson, Star, Canon, Shinwa, Inforunner and Panasonic printers (any others?). It dumps the screen 'side-ways' with minimum distortion—though it still suffers from the Epson problem of oval circles. It copes with all colours in all modes and is impervious

```

.point lda #9          \read logical colour
      ldx #block MOD 256
      ldy #block DIV 256
      lda Xlo          \low byte of X_coord
      sta block
      lda Xhi          \high byte of X_coord
      sta block+1
      lda Ylo
      sta block+2
      lda Yhi
      sta block+3
      jsr &FFF1
      lda #11          \read palette
      ldx #(block+5) MOD 256
      ldy #(block+5) DIV 256
      jsr &FFF1
      rts
    
```

Listing 2.

to VDU19 changes, though it is less than perfect in mode 0 if VDU19 has been used. How it works should be obvious to those who followed the article in the December issue on the universal dump. It is shorter and faster than the December dump (although I don't like the patterns so much) and it overcomes the problems of that dump in normal mode 0 use. Use program 3 as follows.

1. Find the place in the program where you want the dump to occur.
2. If using tape, suppress messages by inserting the line \*OPT1,0.
3. Insert the line VDU7:CHAIN"C/EPAT" (VDU7 gives a signal to start the tape—messages have been suppressed!).
4. Run the resulting program.

Listing 4 (pages xiv-xv) deals with the Canon colour graphics system, which is not unlike that of the Olivetti Spark-Jet printer. It requires colour information to be sent in single horizontal lines. You define the number of dots per line that the printer is to expect, using ESCape "X" n, where n is the number of bytes of dots (ie, number of dots/8). You then send three times that number of bytes—one set for RED information, one for GREEN and one for BLUE. There's also an alternative system which repeats each line a specified number of times. This is ESCape "r" n1 n2, where n2 is the same as n in the ESC "X" sequence.

I decided to use the latter technique, and to step the X co-ordinate by 2, thus reading mode 0 pixels once, modes 1 and 4 pixels twice, and mode 4 pixels four times. This combines with the two-dot-line depth per pixel to give a completely distortion-free picture filling the paper. (The meaning of n1 is one of the serious errors in the manual, which states that the line of dots will be printed n1 times, whereas it is actually

repeated n1 times—ie, printed n1+1 times.)

The dump calculates the physical colour for a point, as described above. On the first pass the least significant bit (LSB), corresponding to the RED information, is rotated into the printer byte, on the second pass the LSB is dumped and bit 1 (GREEN information) is rotated in, and on the third pass the BLUE bit (2) is rotated in. The process is carried out 8 times for each byte, and then that byte is sent to the printer via OSWRCH (equivalent of VDU1,byte).

I have departed from my usual style of short, comprehensible sub-routines for this dump, as there are clear advantages in having the code fit into a single page of memory (ie, within 256 bytes). Furthermore the calling of sub-routines—even in assembly language using jsr—is relatively slow, and this printer is not the most rapid, and so it needs all the help we can give it.

The program is written so that it auto-saves the machine code under the name CANONPJ, which can thereafter be \*RUN (from tape) or run via \*CANONPJ from disc. It saves in the unused cassette buffer if you are using disc, and in page 13 (&D00) if you are using tape. These can be adjusted simply at your own need.

The dump includes a jump instruction at its start. It may be re-operated after initial \*LOADing or \*RUNning by the statement CALL&A00 (disc version) or CALL&D00 (tape version).

Mode 1	
logical colour	physical colour
0	0
1	1
2	3
3	7

Table 1.

# The Data Store

6 CHATTERTON ROAD  
BROMLEY  
KENT

for the BBC MICRO

OFFICIAL ACORN DEALERS

WIDE SELECTION OF SOFTWARE  
AND PERIPHERAL EQUIPMENT  
INCLUDING

EPSON, NEC, SEIKOSHA  
PRINTERS

ZENITH, CABEL  
MONITORS

CUMANA  
DISC-DRIVES

BOOKS AND CABLES AVAILABLE  
plus our personal advice service

MACHINES DELIVERED & SET UP  
IN YOUR HOME

PHONE 01 460 8991 (9.30 - 5.30)  
ORPINGTON 26698 (Evenings)  
(CLOSED WEDNESDAY)

# PAYROLL FOR THE BBC B

For up to 150 employees.  
Designed for dual 40 track disc  
using Random Access Operation

CALCULATES Most tax codes.

Up to 18 N.I. rates.

Tax return information,  
24 fixed or percentage deductions,  
employer's and employee's pensions.

PRINT

Payslips, cheques, bank list,  
Coin and note analysis,  
Departmental accounts,  
Employee's file.

INCLUDES

Pass word, user changeable,  
Master file, user changeable,  
This holds all the tax rates,  
Limits N.I. rates, etc.  
Technical backup and notification of  
any changes in Payroll procedures.  
And many other features.

Price is £49.95 inc VAT, plus 50p p & p from us or from  
selective computer shops.

Send orders to:

C.Y.B. Design Services Ltd.,  
8, Briar Avenue,  
Norbury, London, SW16 3AA.  
Tel: 01-764-5994.

Mailmerge Program £39.95.

Trade enquiries welcome.

# ??

Do you ever wonder what you spend on clothing?  
Do you need to know how much money will be  
in your bank account at the end of the month?

Do you have a part time business?  
Do you run the books for a club or society  
Do you make VAT returns?

THEN YOU NEED THE

## HOME ACCOUNTANT

for only £19.95 (including VAT)

Cassette or Disk versions for the BBC Model 'B'  
(or Model 'A' with 32k RAM)

This package - complete with 41 manual

- keeps a 24 column analysed account  
of payments and receipts\*
- calculates the VAT owed/owing
- produces printed accounts
- handles regular payments automatically

\* Each column in turn could be analysed further by creating new accounts

Send cash/cheque to the Acorn distributor for the  
North West and Wales

# 3SL

System Support Services  
Brook House, 513 Crewe Road,  
Wheelock, Sandbach,  
Cheshire CW11 0QX  
Telephone (09367) 3842 & 61249

# 4

Emmanuel St.

Our *new* Personal  
Computer Centre  
specializing in  
the BBC Micro  
with complete support

*we know computers*

1 Business &  
Professional  
Tel 0223 65335 4



Home &  
Educational 4  
Tel 0223 358264

Cambridge Computer Store

1 & 4 Emmanuel Street, Cambridge

# CROYDON COMPUTER CENTRE



OFFICIAL ACORN SERVICE CENTRE

29 Brigstock Road, Thornton Heath, Surrey.

01-689 1280



MODEL B ACORN ELECTRON £399.00  
£199.00

+ Full range of spares always in stock.



TORCH Z80 DISK PACK £799.00

Includes £1,250 free software.

MIDWICH DRIVES FROM £160.00  
MICROVITEK COLOUR MONITOR £229.00  
ZENITH 12" GREEN OR AMBER £99.00  
CUMANA SLIMLINE DRIVES from £194.00  
EPSON RX80 £333.00  
JUKI DAISYWHEEL £458.85

Full range of books, software, paper and spares for every popular micro and printer. Our four years in the micro business and investment in trained engineers and test equipment is your guarantee of peace of mind.

EXPORT ENQUIRIES WELCOME

Happy customers in twelve countries

ALL PRICES INCLUDE VAT

01-689 1280

FOR SPARES AND REPAIRS  
FAST SERVICE

# Diary & RAM Filing System for the BBC Microcomputer

"The RTC+RAM provides a fast and efficient Diary and RAM filing system that is particularly simple to use."

Acorn User, April 1984.

The Diary is sophisticated, yet simple to use appointments' storage and retrieval system with unique features:

- Available and accessible at any time – no need to load disc or tape.
- Audible alarms at preset times with associated screen messages.
- Automatic reinsertion of repeating reminders.
- Search of appointments by particular words or numbers.
- Easy entry and display of messages.
- Easy access to real time and date from other programs.

RAM filing system provides convenient storage for most frequently used programs and documents.

RTC+RAM system comprises Diary and RFS software in a ROM, electronics in a separate housing (4Kbyte or 30Kbyte storage) and instruction manual.

4Kbyte RTC+RAM £128.00p + VAT + p/p (£149.00p inc.)  
30Kbyte RTC+RAM £300.00p inc. (4Kbyte to 30Kbyte upgrade is available)

Further information from Acacia Computers Limited,  
7 Supanee Court, French's Road, Cambridge CB4 3LB.  
Tel. 0223 312124

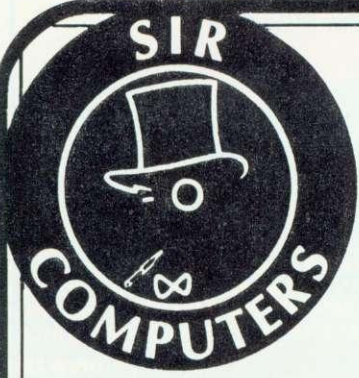
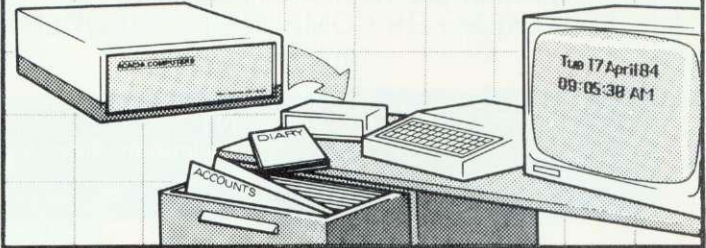

## SIR ROM EXPANSION BOARD MODEL TWO

THE ULTIMATE ROM/RAM EXPANSION SYSTEM FOR THE BBC MICRO

£49.95

- \* 12 extra ROM sockets complement those already provided by the micro to allow up to 256K ROM space.
- \* Four of these sockets can support either ROM or Static RAM (up to 16K maximum RAM).
- \* The Model 2 board allows switching between multiples of 2K, 4K, 8K or 16K ROM/RAM.
- \* Fully compatible with all ROMs, including LDOS, Aries B20, and TORCH Z80 2nd processor card.
- \* NO soldering, plug-in design.
- \* Fits easily inside BBC case.
- \* Plugs into CPU socket via short flexible connector.
- \* Improved plug design allows the Model 2 board to connect securely to any type of BBC CPU socket with no harm to micro or board.
- \* Board is held in place by sturdy supports.
- \* Full instructions provided.
- \* Additional features include the ability to transfer paged firmware to disc, and then load back into sideways RAM for future use – giving you no limit to the number of effective ROMs accessible!

SIR BBC MICRO ROM/RAM EXPANSION BOARD (Model 2): PRICE £49.95

All our prices are inclusive of VAT unless specified otherwise.

Postage & Packing:

Please add £1 for small items (disc drives, software, etc.)  
£10 for larger items (monitors, printers, etc.)  
Access/Barclaycard Telephone orders welcome.

SIR COMPUTERS Ltd.  
91 WHITCHURCH ROAD, CARDIFF CF4 3JP  
Telephone: CARDIFF (0222) 621813

### SIR BUSINESS & COMMUNICATIONS

We announce our appointment as TORCH UNICORN Dealers, at a time when Acorn & TORCH are joining forces...

#### THE TORCH UNICORN RANGE:

CP/M compatible extensions to the BBC Microcomputer System:  
ZEP 100: Z80 2nd processor card; 64K RAM; FREE SOFTWARE (see below) £299 + VAT.

ZDP 240: Z80 Disc Pack comprising ZEP 100; 2 x 400K floppy disc drive; FREE SOFTWARE (see below) £699.00 + VAT.

HDP 240: As ZDP 240 but with one 400K drive replaced by a 20MB Winchester Hard Disc unit around £1,995 + VAT.

HDP 68K: As HDP 240 but with twin (Z80B and 68000) "second" processors; available complete with full UNIX III O.S. around £2,495 + VAT.

TORCH C-500: Complete self-contained unit (NO BBC MICRO REQUIRED) comprising BBC Micro system, ZDP, hi-res colour monitor & British Telecom-approved communication card.  
Price available on application.

FREE SOFTWARE: BBC BASIC (Z80) [allowing almost 48K User Memory!]; 'Perfect' Writer (word processor); 'Perfect' Calc (spreadsheet); 'Perfect' Filer (database filing system); Complete software package normally worth about £1,000!!

#### BBC MICROCOMPUTER

BBC Model B ..... £399.00  
BBC Model BD ..... £469.00

#### MONITORS

Sanyo B/G ..... £85.00  
Microvitek RGB ..... £229.00

#### DISC DRIVES

Single 100K ..... NOW £149.00  
Dual 100K ..... NOW £279.00  
Dual 400K ..... NOW £499.00

#### PRINTERS

Dot Matrix:  
Shinwa CP-80 ..... £263.35  
Epson RX-80 F/T ..... £275.00  
Epson FX-80 ..... £389.00  
Daisywheel:  
Daisytype 2000 ..... £299.00  
Juki 6100 ..... £399.00

#### SOFTWARE

We have over 200 titles currently in stock including ROM based programs such as VIEW (£59.80), HCCS PASCAL (£49.50), Computer Concepts' GRAPHICS ROM (£32.20), WORDWISE (£39.95) and DISC DOCTOR (£29.95).

Please telephone for full details of software range and current stock.

**THE BBC MICRO SOUND SYSTEM  
MICROVOC**

As supplied to Schools & Colleges

**SYSTEM INCLUDES:**

Speakers, Volume control, jack sockets and all connections (assembled) plus Buzzgo to eliminate the infernal B.B.C. buzz.

Easily fitted with no drilling, soldering or cabinet modifications **£23.00** inc VAT and p & p

**MICROVOC WITHOUT SPEAKERS  
£15 inclusive**

Now in stock — The Synth. This program allows the mixing and saving of all four channels, including Channel O for cymbals and drums. Complex melodies can now be entered in minutes by even a complete novice.

**MICROVOC IS IDEAL FOR SPEECH  
SYNTHESIS OR COMPUTER PRODUCED  
MUSIC**

**MICRO-ADVENT**

Ashlyn House, 113 Writtle Road, Chelmsford, Essex.  
Tel: 0245 59708

**VICTOR  
MORRIS  
Glasgow**

Authorised  
**acorn**  **dealer**

**B.B.C. B & acorn  
electron**

Disk Drives, Printers, Joysticks,  
Acornsoft, Data Recorders, Monitors,  
Adds ons by Pace, Torch etc.

**spectrum** Group Dealer

Access, Visa, Amex, Diners

**340 Argyle Street**  
Between Central Station and Anderson Bus Station  
**Glasgow G2**  
Tel: 041-221 8958

**A J SOFTWARE  
for BBC**



'The Record Changer'  
32K **£19.95** Cass. **£24.95** Disc.

for indexing, membership lists, directories, inventories, budgeting, etc, etc.

don't buy a database in the dark —  
check the spec!

'The Wordsmith' 32K for Centronics 737/739  
AND NOW FOR EPSON FX80:

**£19.95** Cass. **£24.95** Disc.

Options Timetable 32K  
**£14.95** Cass. **£19.95** Disc.

Simple Word Processor 32K  
**£9.95** Cass. **£14.95** Disc.

Picture Maths  
**£9.95** Cass. **£12.95** Disc.

An arithmetic practice program for primary schools.

Character Definer **£9.95** Cass.  
Enlarge, reduce, etc, etc.

Tape Catalogue **£5.95** Cass.

Catalogue all your tapes using this program and never lose one again

Copy Disc **£9.95**

Copy disc to tape, tape to disc, M/C, Data or Basic.\*

ROM Read

**£8.95** Cass. **£11.95** Disc.

A machine code program to read the contents of any ROM socket and copy to RAM, tape or disc. Not to be used for illegal copying.

Machine code Disassembler  
**£5.95** Cass. **£7.95** Disc.

Open Evening Timetable 32K  
**£14.95** Cass. **£19.95** Disc.

Utility Eprom **£19.95**  
for basic programmers

Mitsubishi Disc Drives  
Dual 80 Track 800K **£380** + VAT

Single Track Drives  
Dual Sided 200K **£199** + VAT

Double Density Disc Interface **£80** + VAT  
The best there is.

Epson Printers  
FX80 **£370** + VAT **£8.00** Carr  
RX80 **£270** + VAT  
BBC Epson Cable **£15** + VAT

Normende

Not only the cheapest, but the best  
Switchable 14" RGB Monitor/Colour TV **£250** inc. VAT and cable, **£8.00** carr.

Royalties for quality software  
All prices VAT inclusive except where shown

AJ Vision Service Ltd, 61 Jeddo Road  
London W12 9ED

# SOFTWARE INVASION...

Let excitement invade your home computer!  
Travel to Alpha Centauri. Enter the Vortex.  
Command the ground missiles, or join the  
shoot-out at the O.K. Corral!



## GUNSMOKE

...the movement of the saloon-bar door was all the warning he needed! At the speed of light his hand moved toward his holster, while a sixth sense warned him of the upper floor window... 3D ACTION, SOUND EFFECTS, BEAUTIFUL GRAPHICS BBC MODEL B £7.95 CASSETTE £11.95 DISK



## 3D BOMB ALLEY

... the continued thunder of the hissing ground missiles had long now deafened him - unless he had some of those bombers down, the fleet, in the small stretch of water was a sitting duck... 3D ACTION, SOUND EFFECTS, BEAUTIFUL GRAPHICS BBC MODEL B £7.95 CASSETTE £11.95 DISK



## ATTACK ON ALPHA CENTAURI

... he punched the key, and the control monitor filled with the picture of bug-eyed wasps attacking from their volcanic nest; decisively he dived to the left and his laser gun burst into action... 3D ACTION, EXPLOSIVE SOUND EFFECTS BBC MODEL B £7.95 CASSETTE £11.95 DISK



- Distributors, Multiple Store and Retailer Group inquiries invited.
- Available from WH Smith, HMV, all Spectrum shops and over 500 retail outlets in the U.K.

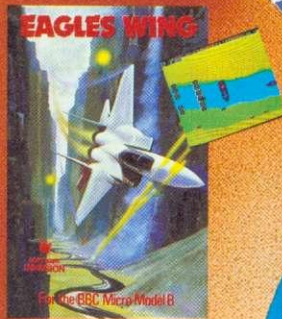

## EAGLES WING

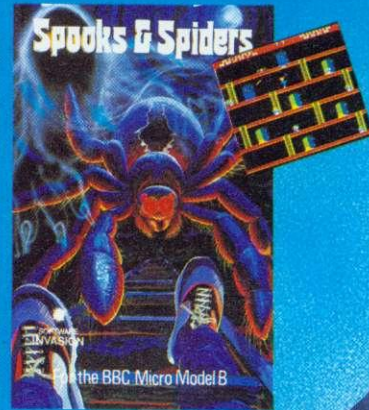

## Spooks & Spiders



**VORTEX**  
... there was no escape, he had to enter the Vortex and bet on his skills! He grabbed the manual controls and with determination fired both upper deck guns... EXCELLENT SOUND KEYBOARD OR JOYSTICK, BBC MODEL B ALSO AVAILABLE ON ACORN ELECTRON CASSETTE FOR £7.95.

**EAGLES WING**  
... he glanced at his fuel levels, a few more seconds of flying time. He had to swing round through the burst of fire to reach the Decking platform, he knew, in two minutes the game could be over... GRAPHICS, REALISTIC COMBAT, SUPERB CONDITIONS. BBC MODEL B, £7.95 CASSETTE, £11.95 DISK.

**Spooks & Spiders**  
... perhaps, very slowly, he could reach the cellar - quietly he started climbing down, his foot slipped as the giant spider dived towards him... SOUND EFFECTS, EXCELLENT GRAPHICS, BBC MODEL B, £7.95 CASSETTE, £11.95 DISK.

**HOW TO ORDER:** You may purchase any of the Games listed from most good BBC Software Stockists, W H Smiths, HMV or your nearest Spectrum Dealer. To order direct, fill in the coupon below with your requirements, make cheque/P.O. payable to SOFTWARE INVASION and post to us. Please allow 7 to 14 days for delivery.  
**OVERSEAS ORDERS:** Please add £0.75p per game ordered.

Do you write your own programmes? If you have an unusual programme which can meet our standards you could be earning more than £250 per week. Why not take advantage of our sought after reputation. Write now!

Post to:  
**SOFTWARE INVASION 50 ELBOROUGH STREET SOUTHFIELDS LONDON SW18 5DN**

GAMES	QNTY	TAPE	DISK	40 TRACK	80 TRACK	£
VORTEX						
VORTEX (Acorn Electron)						
ATTACK ON ALPHACENTOURI						
3D-BOMB ALLEY						
GUNSMOKE						
EAGLES WING						
SPOOKS & SPIDERS						

I enclose my Cheque/P.O. for £.....  
Name \_\_\_\_\_  
Address \_\_\_\_\_

I am a Distributer/Multiple/Retailer/Dealer Please contact me (please delete whichever not applicable).

# SOFTWARE INVASION

50 Elborough St., Southfields, London SW18 5DN.

# Unicorn. Five new channels. Here's the full

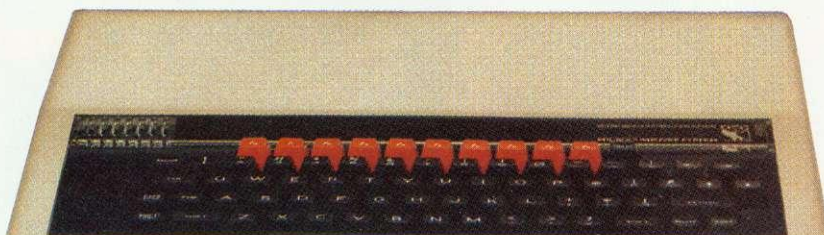

## The ZEP 100

- Z80 Extension Processor
- 4MHz Z80A
- 64K RAM
- 24K ROM

The object of any upgrade kit is to improve processing ability and to increase data storage capacity. The UNICORN ZEP100 is the first stage upgrade which opens channels into the world of serious computing.

The ZEP100 is the proven 8 bit second processor for the BBC Model B micro. A Z80 extension processor which enables the use of the well established CPN operating system, giving access to the vast range of applications programs and languages available for all CP/M<sup>®</sup> micros. When fitted to a BBC model B microcomputer with compatible high quality disc drives it provides a complete business or scientific computer which can run large applications programs or use advanced languages, with the ability to switch back to standard BBC programs at any time.

Any ZEP100 can be linked, via the Econet<sup>®</sup> option on the BBC, to a network of other TORCH computers to provide a workstation running on TORCHNET. Full TORCHNET operating systems software is provided to allow access to information anywhere on the network, or to communicate with other computers.

The 64K ZEP100 is supplied with full software support including word processing, spreadsheet, database and utilities. **The ZEP100 around £299 (ex. VAT).**

The new UNICORN range from TORCH Computers gives the enthusiast and professional user a choice of upgrades which takes the BBC Model B Micro to the ultimate height of performance.

The result of TORCH'S total commitment to the BBC Micro is the only complete range of high performance hardware available. Offering every BBC Micro owner five new upgrade channels, UNICORN will transform your BBC into a fully communicating workstation, a CP/M<sup>®</sup> compatible business machine or the ultimate in high powered 32-bit data processing.

At the top of the range, THE UNICORN, offers the power and sophistication of System III UNIX<sup>®</sup> whilst other channels make available the flexibility of languages such as FORTRAN, PASCAL, BCPL and COBOL. All models, with the exception of the HDP240, provide BBCBASIC (Z80) on the Z80 rather than the Model B's 6502.

Tune in to the Channel that most suits your requirements. Whichever level you choose you can be sure of a system with infinitely expandable potential for a confident future in the world of computing.



# Channels for the BBC. programme.



## The ZDP 240

- 4MHz Z80A ● 64K RAM
- 24K ROM
- Twin, double sided 400K floppy discs
- Independent integral power supply



The UNICORN DP240 (Torch Z80 Disc Pack) is the proven upgrade for the BBC Model B micro-computer. Offering the use of more powerful and flexible languages such as Fortran, Pascal, BCPL and Cobol, it provides 800K of disc storage plus a 80 second processor with 64K RAM running TORCH's own CP/M<sup>®</sup> compatible operating system based in ROM.

This advanced design means that almost all of the 64K RAM provided by the Z80 board is available for CP/M<sup>®</sup> programming use - an advantage no other BBC micro upgrade can offer.

If your BBC micro has the Econet<sup>®</sup> option, there is a further benefit the ZDP240 can offer. TORCHNET can link together up to 54 upgraded Model B's on a local area network, so for enthusiasts, clubs and Schools it is a simple and low-cost way to achieve networking facilities.

The discs can be used for storage under the Acorn DFS system for CP/M<sup>®</sup> programs and data.

A comprehensive software package is provided with the disc pack. It includes word and data processing and a spreadsheet program, along with utility programs and manuals.

The TORCH Z80 Disc pack is recommended by the CCTA for government use. **The ZDP 240 - around £699 (ex. VAT).**

## The HDP 240

- 20Mbyte hard disc Winchester
- Double sided 400K floppy disc
- Integral power supply

For users who need much more storage capacity than is available on floppy discs and who require the large speed gains that a Winchester hard disc provides, the third new channel is now available. The UNICORN HDP240 combines a 400K floppy disc drive with a 20Mb hard disc and its associated controller. The pack connects directly to the disc and 1MHz bus sockets on the BBC Model B.

In conjunction with a ZEPI100, it provides a powerful business computer for running CP/M<sup>®</sup> programs with large amounts of data. The floppy disc can be used for storage with the Acorn DFS system, and both discs can be used by other TORCH systems on the TORCHNET local area network. **The HDP240 - around £1995 (ex. VAT).**

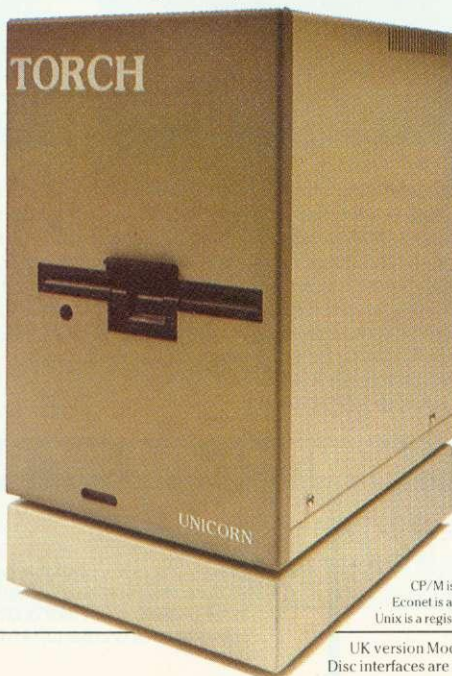

## The HDP68K

- 8MHz MC68000 ● 6MHz Z80B
- 256K RAM (68000)
- 64K RAM (Z80)
- 20 Mbyte hard disc Winchester
- Double sided 400K floppy disc
- Integral power supply

The fourth channel in the UNICORN range is for users who need the extra processing power of a 68000 32 bit processor, as well as the Z80 running standard software. The UNICORN HDP68K provides the ultimate in performance, offering an extra 256K RAM and a 68000 processor running at 8 million cycles per second. It also contains a Z80 processor to allow the running of existing TORCH software.

**The HDP68K - around £2495 (ex. VAT).**

## The Unicorn

Spec. as HDP68K PLUS UNIX<sup>®</sup> operating system.

UNIX<sup>®</sup> System III is the recognised operating system of the '80's. A very powerful and sophisticated multi-tasking system, it includes a vast library of utility programmes.

The fifth channel and top of the range, THE UNICORN, puts UNIX<sup>®</sup> within reach of the individual user, at a price unmatched by any other UNIX<sup>®</sup> systems, by combining the reliability of the BBC micro with advanced technology from TORCH Computers.

TORCH UNIX operates under the network operating system. Using UNICORN products, a low-cost network of BBC Micros can be configured to offer the most complete range of educational computing facilities available anywhere.

Other facilities available include UCSDp-System, LISP, FORTH, PILOT and PROLOG. **The UNICORN - around £2895 (ex. VAT).**

# UNICORN

Open channels for the BBC micro.

To: Torch Computers Ltd., Abberley House,  
Great Shelford, Cambridge CB2 5LQ.  
Telephone: Cambridge (0223) 841000.

Please send further information on the UNICORN range plus your FREE 1984 Software Catalogue.

Name \_\_\_\_\_

Address \_\_\_\_\_



AU 7

**TORCH**  
COMPUTERS



CP/M is a registered trademark of Digital Research Inc.  
Econet is a registered trademark of Acorn Computers Ltd.  
Unix is a registered trademark of Bell Telephone Laboratories Inc.

UK version Model B necessary.  
Disc interfaces are necessary for use with the Unicorn range.

Text and Graphics provided by BBC Model B.  
Keyboard provided by BBC Model B.

**SPECIAL OFFER!**

Order both directly from us and deduct £1 from each.

# TWO SENSATIONAL NEW RELEASES FROM SUPERIOR SOFTWARE

# BBC MICRO

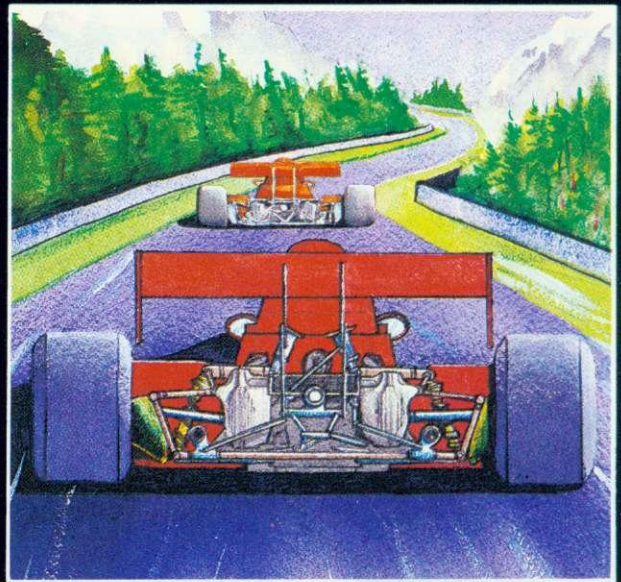

### OVERDRIVE (32K)

£7.95

A highly-addictive multi-stage 3D race game. You steer your car left and right, accelerate and decelerate as the opposing cars weave about the road. There are five different stages including night, snow, desert, and riverside scenes. To qualify for the next stage, you must finish in the top twelve. Incredible graphics give the impression that you really are taking part in the race. Highly recommended, and destined to become another top-seller for Superior Software.

●●●NEW RELEASE●●●

**OUR PROGRAMS ARE NOW AVAILABLE FROM OVER 1000 OUTLETS THROUGHOUT THE UK AND OVERSEAS. SEE YOUR LOCAL DEALER!**

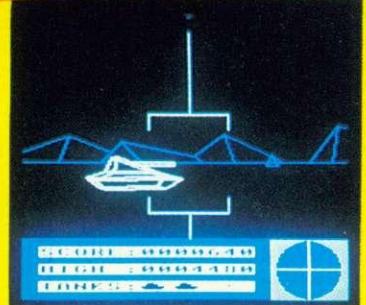
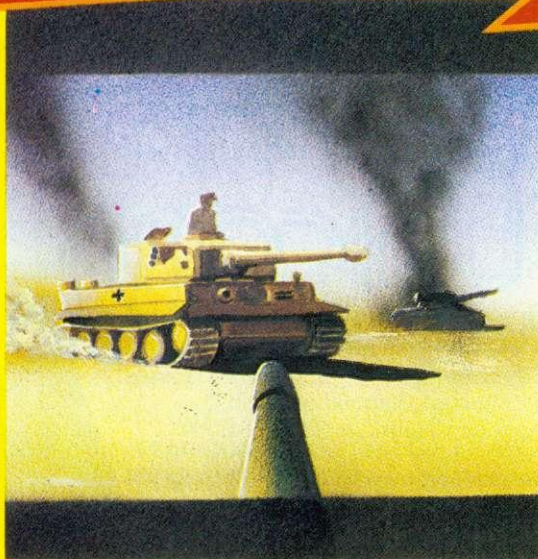

### BATTLETANK (32K)

£7.95

An excellent game, made possible on the BBC computer only by the unique use of a dual-screen display and specially written plotting routines. You are a tank gunner looking out onto a mountain plateau. You see the distant mountains and the pyramid obstacles – and also the enemy tank. Your task is to shoot it before it shoots you. A scanner is displayed in the bottom right-hand corner of the screen. This displays the position of the enemy tank relative to you. You can then turn to get the tank in view. The next stage is to position the tank in the rectangular viewfinder by fine adjustments of your controls.

(KEYBOARD or JOYSTICKS)

●●●NEW RELEASE●●●

**WE PAY UP TO 20% ROYALTIES FOR HIGH QUALITY BBC MICRO AND ELECTRON PROGRAMS**



### SUPERIOR SOFTWARE LTD.

Dept. AU5, Regent House,  
Skinner Lane, Leeds 7  
Tel: 0532 459453

### OUR GUARANTEE

- (1) All our software is available before we advertise.
- (2) All our software is despatched within 48 hours by first-class post.
- (3) In the unlikely event that any of our software fails to load, return your cassette to us and we will immediately send a replacement.



WITH MORE BRANCHES THAN  
ANY OTHER ACORN DEALER  
WE OFFER

## ONE-STOP SHOPPING

FOR YOUR  
**BBC MICRO**  
AND  
**ELECTRON**

WE REFUSE TO BE UNDERSOLD  
AND WILL MATCH THE LOWEST  
ADVERTISED PRICE ON ALL  
PRODUCTS.

INSTANT CREDIT UP TO £1000.

### SOFTWARE

PROGRAM POWER  
BUG-BYTE  
SUPERIOR SOFTWARE  
A & F  
SIMON HESSEL  
MOLIMERX  
ALLIGATA  
ACORNSOFT

### PERIPHERALS

DISCS SINGLE/DUAL  
TORCH Z80 DISCS  
CUMANA DISCS  
PRINTERS  
JOYSTICKS  
MONITORS  
B & W/COLOUR  
LIGHT PENS  
BBC BUGGY

*large range of books,  
diskettes, cassettes &  
printer paper always  
in stock*

### TOLWORTH

230 Tolworth Rise South,  
Tolworth, Surbiton,  
Surrey KT5 9NB.  
Tel: 01-337 4317

### SUTTON

30 Station Road,  
Belmont, Sutton,  
Surrey SM2 6BS.  
Tel: 01-642 2534

### EALING

114 Gunnersbury Avenue,  
Ealing, London W5 4HB.  
Tel: 01-992 5855

### NEWBURY

26, Stanley Road,  
Newbury  
Berks RG14 7PB.  
Tel: (0635) 30047

### RICKMANSWORTH

Grey Stone Works,  
The Green, Croxley Green,  
Rickmansworth,  
Herts WO3 3AJ.  
Tel: 0923 779250

### LUTON

1 Manor Road,  
Caddington, Luton,  
Beds LU1 4EE  
Tel: (0582) 458575

## BBC Micro Fanatics Required

Do you know your way around the  
BBC Micro — spend your spare time  
using it?

**Beebugsoft — the software house of Beebug  
Publications Ltd. has vacancies for young per-  
sons with software expertise (Basic and/or  
Assembler) on the BBC Micro.**

Continued expansion at BEEBUGSOFT  
has created further vacancies for young  
persons with expertise on the BBC  
Micro.

Successful applicants will join a grow-  
ing team of enthusiasts developing new  
software for the BBC Micro and Elec-  
tron.

Work will be varied and, where possible,  
reflect the interests and expertise of the  
applicant. Salary according to experi-  
ence.

Applications should be made in writing  
to the address below, and should  
include a full curriculum vitae together  
with the names of two referees.

***The Software Manager***  
**BEEBUGSOFT, PO BOX 50**  
**ST. ALBANS, HERTS.**

# BBC MICRO

## - USER SUPPORT -

LOOK WHAT YOU  
MISSED IN BEEBUG  
VOLUME TWO

- 10 ISSUES OF BEEBUG MAGAZINE  
MAILED FREE TO MEMBERS
- 30 EXCITING GAMES AND VISUAL PROGRAMS
- 43 SOFTWARE REVIEWS
- 33 HARDWARE REVIEWS
- 16 BOOK REVIEWS
- 150 HINTS AND TIPS
- 25 APPLICATION PROGRAMS
- SERIES OF ARTICLES FOR BEGINNERS
- MANY ADVANCED TECHNICAL ARTICLES
- NEWS AND PRODUCT INFORMATION
- PLUS SPECIAL OFFERS
- BIG DISCOUNTS ON A WIDE RANGE OF PRODUCTS
- EVENTS
- BRAIN TEASERS
- LOCAL CLUBS
- FULL MAGAZINE INDEX

**A YEARS SUBSCRIPTION WOULD HAVE BOUGHT YOU ALL THIS**

*Figures based on the 10 issues of BEEBUG Volume 2.*

**BUT IT'S NOT TOO LATE TO JOIN FOR VOLUME THREE**

BEEBUG PUBLICATIONS LTD. PO BOX 109, HIGH WYCOMBE, BUCKS

PLEASE ENROL ME FOR VOLUME 3  
OF BEEBUG AT £9.90 (10 ISSUES)

NAME .....

ADDRESS .....

AMOUNT ENCLOSED .....

PLEASE MAKE CHEQUES PAYABLE TO  
BEEBUG PUBLICATIONS LTD.  
AND SEND TO:- DEPT 13, PO BOX 109  
HIGH WYCOMBE, BUCKS.  
(DISTRIBUTION AGENTS FOR BEEBUG)

**BEEBUG HAS BEEN  
ESTABLISHED FOR TWO  
YEARS AND NOW HAS  
OVER 25,000 MEMBERS. IT  
OFFERS TOTAL USER  
SUPPORT TO ALL BBC  
MICRO USERS.**



**ACORN USER Subscriptions**

**Redwood Publishing**

**68 Long Acre**

**London WC2E 9JH**

**ACORN USER Services**

**PHS Mailing Ltd**

**PO Box 14**

**HORLEY**

**Surrey**

**ACORN USER Software**

**PHS Mailing Ltd**

**PO Box 14**

**HORLEY**

**Surrey**

Authorised

**acorn**  **dealer**

**B.B.C. B & acorn  
electron**

CUMANA disk drives  
DECCACOLOUR & MICROVITEC monitors  
SEIKOSHA, EPSON & DAISYSTEP printers  
ACORNSOFT/MERLE business software  
ACORNSOFT full range

**NEXUS HOUSE  
2 CRAY ROAD  
SIDCUP, KENT  
01 300 3075/6**

ACCESS/BARCLAYCARD WELCOME

# The Incredible HULK (£25 + VAT)

HULK is the poor man's knowledge engineer. Knowledge engineering is the new approach to software design which underlies the dramatic success of recent expert systems.

The HULK package (so called because it Helps Uncover Latent Knowledge) offers users of the BBC and Torch microcomputers a low-cost route into knowledge engineering. It will enable you to build up and test a set of decision rules which can be used for prediction or classification. Thus HULK takes the donkey work out of developing a 'knowledge base'.

This is what the Practical Computing software review said about HULK:

"It is very quick and interactive and justifies its name - it does help uncover latent knowledge."

"It can genuinely help people to make sound decisions - and bad decisions are extremely costly in many enterprises." (March 1984 issue).

HULK is available at £28.75 including VAT for BBC/B (preferably with disks) or Torch microcomputers. We will also make it available for the QL as soon as Uncle Clive lets us have one! Cheque/PO with order form:

**Warm Boot Limited  
40 Bowling Green Lane  
London EC1R 0NE (01-278 0333).**

[We can also supply xForth at £65 + VAT and BDS C Compiler at £110 + VAT in Torch disc format.]

## WALTON ASSOCIATES

**START PROFESSIONAL  
STAY PROFESSIONAL**

With a Library of Disc Based Utility Programs  
For the BBC Micro Model B  
(Compatible with all ACORN type DFS systems)

### AUTO SELECT

Includes: Professional Screen Layout, Automatic Menu Production, Automatic Load Mode Selection (CHAIN/\*RUN/\*LOAD/\*EXEC), Pre-programmed Function Keys, Multiple Disc Drives Supported, Easy Selection of Any Program on Any Disc, Easy Selection for Key ROMs, Supports Sideways RAM systems.

Code WA1 Price £ 8.50

### PROGRAM DEVELOPMENT

Includes: Flexible Control of Screen/Printer, Formatted Program Listings (Indents and splits multiple statement lines), Extensive Use of Function Keys, Auto-List of Error Line, Easy Program LOAD/SAVE/VERIFY.

Code WA2 Price £ 8.00

### MULTIPLE DISC CATALOGUE

Used with either Wordwise or View, insert discs one by one to produce a complete and fully sorted catalogue of your whole diskette library. This can be edited, printed or formatted in any manner you wish.

Code WA3 Price £ 6.50

### DISC BACK UP AND VERIFICATION

This utility greatly assists the necessary task of making secure backup copies of your diskettes.

Code WA4 Price £ 4.50

Prices quoted are for utilities only, add £4 to total order price to cover, cost of diskette (state 40/80 tracks), post and package.

To Order: Phone 0908 - 563805/71714, or write to:

WALTON ASSOCIATES  
2 Red House Close  
Newton Longville  
MILTON KEYNES  
MK17 0AH

## WEST OF SCOTLAND

**BBC & ATOM DEALER AND  
SERVICE CENTRE**

### HARDWARE

Model B with Disc Interface **£469.00 inc.**  
Model B **£399.00 inc.**  
Postage & Packing **£6.00 inc.**

### SOFTWARE

Acornsoft Bug Byte Program Power  
also 30 Golf Fruit Machine Dodgems  
Send SAE for full list

### MONITORS PRINTERS

A selection on display A

Upgrades carried out  
Disk and Econet interfaces fitted  
Also a wide selection of books and magazines

**WEST COAST  
PERSONAL COMPUTERS**

47 Kyle Street, AYR  
Tel 0292 (285082)



# HIGH RESOLUTION THAT COMES HIGHLY RECOMMENDED.

**“There is no doubt that the JVC range of ECM colour monitors is excellent value for money . . . there is no loss in quality of picture after long periods . . . and remember, as more and more resolution is available with new micros, the need for a better display will be that much greater.”**

High recommendation indeed from Personal Computer News. Meanwhile Acorn User said:

**“It seems that all ‘normal’ and ‘medium’ resolution monitors, including the Sanyo, are simply inadequate to deal with the Beeb’s graphics and text output . . . The JVC was excellent, giving clear, legible results . . . Was the JVC better than the Microvitec? \* Would I buy one? Yes to both questions.”**

Our RGB high resolution colour monitor (580 × 470 pixels) sells for £229.95 (excluding VAT) – that’s a saving of over £100 compared with other leading monitors of similar specifications.

The unit has a 14” screen and is suitable for the BBC Micro, Electron, Sinclair QL, Lynx, Oric, Apple, IBM and most other leading micros.

MODEL REFERENCE	1302-2 High Resolution
RESOLUTION	580×470 Pixels
C.R.T.	14”
SUPPLY	220/240v: 50/60Hz.
E.H.T.	Minimum 19.5kv Maximum 22.5kv
VIDEO BAND WIDTH	10MHz.
DISPLAY	80 characters by 25 lines
SLOT PITCH	0.41mm
INPUT: VIDEO	R.G.B. Analogue/TTL Input
SYNC	Separate Sync on R.G.B. Positive or Negative
EXTERNAL CONTROLS	On/off switch and brightness control

And naturally there’s a year’s full guarantee. If you order your monitor by post, you’ll receive it within ten days by courier service.

Simply post the coupon below to: Opus Supplies Ltd, 158 Camberwell Road, London SE5 0EE. Or telephone 01-701 8668 quoting your credit card number. Or, of course, you can buy at our showroom between 9.00–6.00pm, Monday–Friday 9.00–1.30pm, Saturday.

\*Microvitec Cub 14” monitor

To: Opus Supplies Ltd., 158 Camberwell Road, London SE5 0EE.  
Please send me:

\_\_\_\_\_ High Resolution Colour Monitor(s) at  
£229.95 each (ex. VAT).

\_\_\_\_\_ Connection lead(s) at £6.00 each.

I understand carriage per monitor will cost an extra £7.00.  
(N.B. A High Resolution Monitor including VAT, lead and carriage costs £279.39).

I enclose a cheque for £\_\_\_\_\_ Or please debit my credit card  
account with the amount of £\_\_\_\_\_ My Access/Barclaycard

(please tick) no. is \_\_\_\_\_

Please state the make of your computer \_\_\_\_\_

Name \_\_\_\_\_ AC 21

Address \_\_\_\_\_

Telephone \_\_\_\_\_

**Opus.**  
Opus Supplies Ltd.



# THE MICRO PULSE 3 INCH 100K DISK DRIVE + MIRROR



Single Disc Drive  
£149.95  
+ VAT

- ✦ Assembled in Britain
- ✦ Robust metal case, BBC beige colour
- ✦ Complete with BBC cable
- ✦ Fully compatible with Acorn /BBC DFS
- ✦ Can be linked in tandem with 5 1/4" disc drive for easy transfer of software
- ✦ Red/Green LED indicates which side of the disc is in use
- ✦ Includes 38 page disc operating system manual
- ✦ Includes 40/80 track formatter utility disc
- ✦ Uses standard Hitachi hard-cased 3" discs (automatic steel shutter protects exposed part of disc surface)
- ✦ Additional double-sided 3" discs available ex-stock

✦ DUAL 3 INCH (2 x 100K) DISC DRIVE **£299.95** + VAT

✦ MIRROR 3" CASSETTE-to-DISC utility program Discette  
Up-loads approx 20 cassette-based programs ...  
(10 on each side of the disc) ...

**£9.00** + VAT

Trade enquiries welcome

please contact: Gareth Littler  
Mark Howard or  
Judith Allen at  
Micro Pulse  
Division



Churchfield Road,  
FRODSHAM  
Cheshire WA6 6RD  
Tel: 0928 35110

# THE MICRO PULSE EXTERNAL ROM BOARDS

For the BBC Computer and the  
Acorn Electron

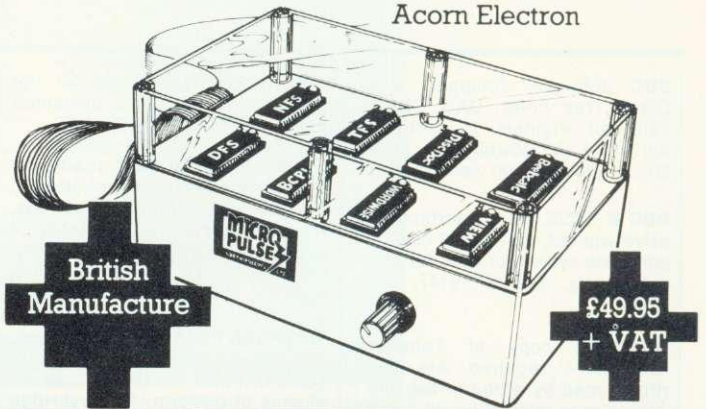

British  
Manufacture

£49.95  
+ VAT

- ✦ BRITISH MANUFACTURE
- ✦ ALLOWS 8 ROMS ON LINE
- ✦ HARDWARE-BASED ROM SELECTION AVOIDS SOFTWARE INTERACTION BETWEEN UTILITY ROMS
- ✦ SWITCH TO REQUIRED ROM USING MANUAL SWITCH OUTSIDE THE UNIT
- ✦ RED LIGHTS INDICATE THE SELECTED ROM
- ✦ HIT "BREAK" TO ACCESS ROM, NO NEED TO USE SOFTWARE COMMAND
- ✦ INCLUDES ZIF SOCKET, FOR INSTANT CHANGING OF A SELECTED ROM
- ✦ INCLUDES BBC CABLE AND ROM SOCKET CONNECTOR
- ✦ INCLUDES SIMPLE FITTING INSTRUCTIONS, JUST PLUG IN AND GO!

please contact: Gareth Littler  
Mark Howard or  
Judith Allen at  
Micro Pulse  
Division



Churchfield Road,  
FRODSHAM  
Cheshire WA6 6RD  
Tel: 0928 35110

## ACORN USER ADVERTISEMENT PAGES – JULY ISSUE

AB Designs	128	Discotek	105	Midwich	80
Acacia	169	Dobsoft	140	Mirrorsoft	150
Acorn Soft	20/21			Molimerx	146
Acorn User Show	6	Educational Electronics	110		
Advent	170	Elbug	136	Northern Computers	182
AJ Vision	170	Electronequip	24/25		
Akhter	116	EMS (Programming)	120	Opus	76/124/151/180
Alphadisk	59	Epic	106		
Ampalsoft	30			Pace	52
Applied Real Time Systems	128	Flightdeck	17	Printerland	104
				Proxima	154
		GCC (Cambridge)	68		
		Gemini	64	Redhatch	134
Beebug	175/176	Golem	106	Robot	117
Beebugsoft	40/41	Graphitek Electronics Ltd	23		
Bei Tech	62	Guardian Software	112	Salamander	88
Benwick Electronics	120			Screens	140
Birdseye Walls	8	Harris McCutcheon	98	Shard Software	114
Bits & Bytes	130	Harvard Apparatus	117	Silent Computers	134
British Telecom	148			Simonssoft	17
Broadway Electronics	158	Ikon	156	SIR Computers	162/169
		Inmac	11	Skywave	151
		Intech	100	Slogger Software	162
Cambridge Computer Consultants	144	Intelligent Interfaces	70/71	Software Invasion	171
Cambridge Computer Store	168	Interface	130	Solidisk	118/119
Cambridge Micro-Processor	120	Interface Components	64	Spider Systems	102
Chase Data	96/97	Intersoft	134	Superior Software	43/91/174/IBC
Cheetah Marketing	122			Synergy Software	152
CJE Micros	72	Kansas	42	System	160
Clares	74	Kosmos	140		
Computer Concepts	16/82/164			T-Soft	104
Computer Room	134	Learnwell	23	Tec Media	78
Computer Town	84/85	Level 9	138	Technomatic	12/13/14
Computerama	66	Lion House Micros	55/56/57/58	Three D Computers	175
Comtec	104	LVL	IFC	Three SL	168
Control Universal	90			Torch	172/173
Croydon Computer Centre	169	Mayfair Micros	132	Tutorial Software	112
Cumana	92/93	Merlin	26		
CYB Design	168	Micheals Business Systems	23	Victor-Morris	170
		Micro-Fast	39	Viglen	127/129/131/132/133
		Micro-Fix	106	Vine Micros	64
		Micro-Man	17	Vision	22
		Micro-Peripherals	19	Voltmace	78
		Micro-Resources	98		
		Micro-Test	1	Walton Associates	179
		Micro-Vitec	107	Warm Boot Ltd	179
		Microaid	15	Watford	44/45/46/47/48/49/50
		Micropower	36/37/73/OBC	West Coast Personal	179
		Microstyle	142/143	Sorting Program Courtesy of Gemini	
		Microtek Computer Services	179		
		Microware	89		



■ **Nutcrackers** tape2tape + tape2disc + disc2tape + disc2disc: the best package available. Comparable software sells for £10 per item. R-Soft, 22 Marriotts Close, Felmersham, Beds MK43 7HD. Tel: (0234) 781730.

■ **AC Linear** Circuit Analysis Program for BBC model B. Analyses circuits with up to 16 nodes and 60 components. Cassette £35, disc £45. Tel: Number One Systems, (0480) 61778. Access/American Express.

■ **Anagram** generating program. (BBC). Ideal for crosswords, quizzes, competitions. Allows any characters to be fixed; gives total number of anagrams; rejects duplicates. Cassette £3.95 inclusive. Cylindrical Software, 3/177 College Road, Birmingham B13 9LJ.

■ **Physics** teachers animated graphics programs including logic circuit design, motors, ripple tanks, electrolysis, optics, sound, bell, colour, result plotting, £3 each. Full details. Tel: 021-449 6648.

■ **40/80** track switching unit for 80 track BBC single/double drives. All instructions supplied, £10 inc. 259 Manor Road, London E15 3AW. Tel: 01-476 5238.

■ **27128** and 2764 blank EPROMs are not in such short supply as some people would have you believe! Latest news on CME's hotline, (0473) 77992.

■ **Dust** covers. BBC & Electron. Made-to-measure in quality natural vinyl with cut-outs for terminal leads. Just send £2.95 (no stamp required) to Allen Enterprises, Freepost, Luton LU2 8BR.

■ **27128** EPROM, Fujitsu 300nS. BBC sideways ROM compatible. One off £18. Five off £17 each. UFF Design, 1 & 2 The Corner, Horsey, Gt. Yarmouth, Norfolk NR29 4EH.

■ **Sporting** forecasts programs by Professor Frank George for BBC 32k. Horse race forecast, football forecast and poolperm. Details from Poringware, P.O. Box 161, Brundall, Norwich.

■ **Beamscan**. Beam design for architects, engineers in both steel and timber to BS.449 and CP.112. Printout satisfies L.A. requirements. Disc £45, cassette £40. Beamscan, 20 Vaughan Avenue, Hendon, London, NW4 4HU. Tel: 202 8656.

■ **Romread**—a sideways ROM utility. Moves ROM's to disc tape and then to sideways RAM, relocates ROMs into RAM, gives instant directory of ROMs in your machine, adds OS commands "Size" and "Media". Only £5.50 from Compromise Consultants, 20a Kings Avenue, Woodford Green, Essex IG8 0JA.

■ **Printer** software for BBC micro and Epson FX80. Two screen dumps, business forms generator and character set redefiner. Tape £11.95, disc £15.95. Sae for further details. Processor Applications, 22 Mercer Close, Basingstoke, Hants.

■ **Horse** Race forecasting program, £12. It picked the 1983 Grand National winner! Football pools forecasting program, £12. Electron, BBC, Spectrum. Send cheque or P.O. to The Butronics, Penterrick House, Budock, Falmouth, Cornwall.

■ **Bored** with aliens? Try Kalahari. Ancient game of strategy. BBC (B). Three skill levels. Good documentation and help screens teach you to play. Cassette £5.95. Sixth Sense Software, 20 Somerset Folly, Timsbury, Bath.

■ **Unbelievable** but true! Cleomos Software put up to 3 absolutely top quality games on 1 cassette for £7.95! Arcade games, games of deduction, plus other cassettes. Available at W. H. Smith for only £6.95.

■ **Discounts** on computers and peripherals, most makes, large and small, hardware only. Some used equipment bought and sold. Tel: Ascot 26875 or Crawley 883853.

■ **Superior** Mover, moves Hunchback, QBert, Roadrunner, etc to disk, ready to run. Other utilities, see previous Acorn Users. R-Soft, 22 Marriotts Close, Felmersham, Beds. MK43 7HD. Tel: (0234) 781730.

■ **BBC** "Image", tape back-up copier. Copies practically anything. Copies with locks, files, 300+1200 baud, any length, false load addresses, etc. Unlocks/locks programs. 100% M/C, £3.80. P. Donn, 33 Little Gaynes Lane, Upminster, Essex RM14 2JR.

■ **"I think** with 'Number Skrable' (BBC 32k, £6.10), you've a winner! Plenty of good maths and fun!" Educational Computer. Bryants, 1 The Hollies, Bognor Regis PO21 5SX.

■ **Juki** printer driving for View. Microspacing, underlining, bold, shadow, pad, pound. 40/80 disc or cassette, £6.50. Amurtec Software, 27 Prideaux Road, Ivy-bridge, Devon PL21 0JS.

■ **Sideways** ROM module for BBC. Each plug-in module supports 4 switch selectable ROMs (may include 2x8k EPROMs, ie 16k). SAE for details to S. R. Electronics, 9 Haddon Drive, Balderston, Newark, Notts NG24 3HN.

■ **Superior** Mover moves programs like Hunchback, Roadrunner, etc to disk, £5. Nutcrackers Tape 2 Tape + Tape 2 Disk + Disc 2 Tape + Disc 2 Disc (will handle locked files), £5. Super disk menu, £5. R-Soft, 22 Marriotts Close, Felmersham, MK43 7HD, Beds. Tel: (0234) 781730.

■ **Graphics** Utilities. \*GSAVE saves mode, palette, & screen to disk in compacted form. \*GLOAD reloads screen in approximately 2 seconds. Ideal for computer slide shows, education, games etc. 40/80 track (state which), £9.50. J. D. Watson, 84 Albert Road, Caversham, Reading RG4 7PL. Tel: (0734) 470588.

■ **Simcon** Tank level controller simulation with colour-mimic for dynamic modelling. Ideal training aid. Cassette £25. Details: Scitech Software, P.O. Box 6, West Kilbride, Ayrshire, KA23 9HY.

■ **Globe-Test** world geography quiz for BBC B: Countries, capitals, rivers, deserts, mountain ranges, oceans, seas. Stunning graphics. Cassette £7, disk £9. Newbytes, 3 Hickory Drive, Harestock, Winchester SO22 6NJ.

■ **Printers** for BBC. RS232 interface. 180 CPS. Bidirectional printing. Dot matrix 7x9. True descenders. Buffered. Various baud rates. Variable tractor settings, ideal for users requiring fast continuous printing. £80. Tel: Crowthorne (0344) 776894.

■ **BBC** micros inoperable without your password. Embedded, encrypted I.C. revealing proof of ownership on request, OS1.00 onwards. Send name, address, password, 12 characters maximum, £18. M. Gillett, 135 Honey Lane, Waltham Abbey, Essex.

■ **User** Guide binders. Stiff plastic backed 16-ring titled open flat binders. £3.50 inc p & p. Hepworth, Waulkmill Farm, Ingersley Vale, Bollington, Macclesfield, Cheshire SK10 5BP.

■ **Data Crunch**, suite of programs for common parametric, non-parametric and regression statistics, £12 each. SAE, OUS Software, Wayside House, Letchworth Lane, Letchworth, Herts. (BBC 32k).

■ **Copyking**—Supreme tape copier. Copies almost anything. Locks/unlocks. Up to ten programs repeatedly saved. Full length, disguised load address and headers catered for. BBC B+OS1.2. £3.50. T. Thornham, 6 The Meadows, Walberton, W. Sussex BN18 0PB.

■ **Multiple** choice question program, BBC tape, disc, Electron. Permits more than one correct answer, space for explanation, hard copy etc. Tape £8.50, disc £10.50. Details: Moreton, 91 Umberslade Road, Birmingham B29 7SB.

■ **Epson (FX)/View** wordprocessor printer driver. Extensive use of printer facilities including: elite, italics, proportional character spacing, etc. 40-track disc, only £7.50 including documentation. Rose Gardens, Penstraze, Chacewater, Truro, Cornwall TR4 8PN.

■ **BBC** keypad. Speed up data entry with 25-key add-on. Eliminates shift for + \* = etc. £50 total. SAE for details: Extron, 16 Priory Park, Bradford-on-Avon, Wiltshire BA15 1QU.

## £10 SMALL AD SERVICE

Please include your cheque for £10 made payable to Redwood Publishing. This is the standard fee. Don't forget your name, address or phone number. Send cheque plus form to Acorn User Small Ads, 68 Long Acre, London WC2E 9JH.

# ACORN ABUSER'S

Diary

184

## Unmasked: magman they couldn't gag

CURIOUSER and curiouser. Derek Meakin, the 'head of National Micro Centres', as he is proclaimed from his own press release, has spoken out against Mastertronic for slashing the price of its games software to £1.99.

Funny, says we, haven't we heard the name Derek Meakin somewhere else? And his address in St Petersgate, Manchester: isn't that also familiar? Ah, yes, that's the address of Optima Software. That must be why it's familiar.

But what about the phone number given for information, 061-456 8383? Try ringing that and you get Database Publications! Could it be that some user magazines are not as independent as they claim?

## Torch in opposition

SSSSH! Don't tell the Tories... but Labour leader Neil Kinnock has gone and got himself a Torch.

Trouble is we can't throw much more light on this particular Torch because they are all so *fwightfully* busy round at the Leader of the Opposition's offices.

The chap in charge of the machine is one Charles Clarke, but when tackled about the Torch he was in far too much of a flap to talk about it.

Asked what they were going to use it for, all Mr Clarke had time to gasp was: 'Awfully busy right now. Can you call later... in about a month's

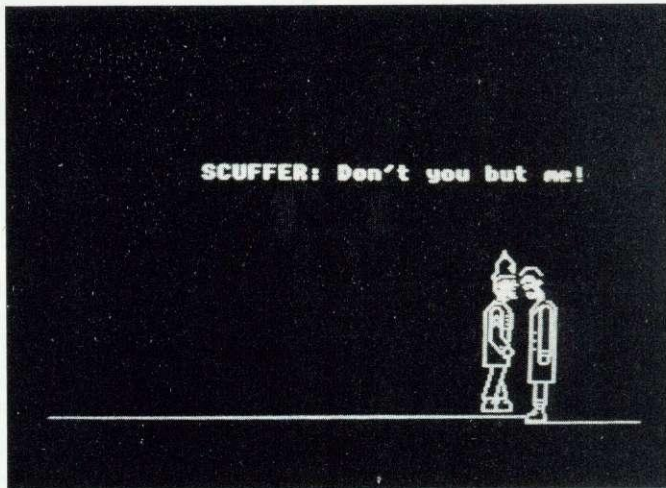

time!' Some comedian.

However, the Curse of the Acorn Abuser struck the next day: a wordprocessed press release from the office went out with the last paragraph missing!

## Bad call

JEREMY Ruston, who's having legal wrangles with Acorn over his latest book which pulls apart the Basic ROM, recently discovered just how good Acorn's communications are. A surprise telephone call from a programmer at Acorn's American operation who was trying to write a spreadsheet interrupted his scribing. It turned out that the only source of advice on the Basic ROM the American could find was - you guessed it - Jeremy. Having a book banned isn't the end of the world after all.

## Quite Likely

AS PART of its rapid growth programme which has already taken in Torch and Torus, Acorn is soon to announce the takeover of an even larger and more established Cambridge-based company.

Dr Alex Reid, director of company purchasing, commented: 'I cannot yet reveal who it is, but we have sent off

the cheque and we have been promised 28-day delivery with a free gift if they are late.'

## Pornographics

A NEW company is being set up to publish the growing range of black market pornographic programs. Acornhard will only sell through high street 'adult' stores and selected bent dealers.

## Wildcards

SECURITY-minded bods at Cherry Hinton have installed a cardkey doorlock system for Acorn's new high-tech R&D building.

Mastermind of the operation was Andrew Mackintosh, formerly head of Lisa development at Apple and now Acorn's head of advanced R&D.

Claimed Andrew: 'The idea of the system is not to stop journalists creeping in at the dead of night to see our top-secret 68032 second processors. It was installed to prevent some of our hairy hardware engineers getting out.'

## Bitter blow

ANONYMOUS letter from Acorn's Cherry Hinton HQ concerning June's issue to our Ed:

## Coming clean...

REMEMBER 'Yossa' and 'Bones' - the two clean programs on the naughty Sisoft disc which was mentioned last month? Well, someone has owned up to them. It's MRM Software up in Grimsby with a skeleton in the cupboard and, by an amazing coincidence, their ad was facing the Diary page on which we revealed the existence of the blue disc. However, a high-ranking spokesman for MRM denied that they'd written the other programs.

*Dear Tony Quinn, What's with the Freudian slips!! ZX80 indeed! You won't live that one down in a hurry. Serves you right! Yours in a huff.*

Only comment from Ed: 'What a load of wind.'

## Quote quota

ACORN has hit out at magazines that publish anonymous comments as official policy. In a sharply worded statement a spokesman said 'The magazines are killing the goose that lays the silver lining.'

He also claimed that rumours of marketing man Tom Hummingbird's replacement by a third generation android were 'utterly groundless. I'm as fifth generation as Tony Quill. Oops! Don't quote me on that.'

Querty is three months old and still having his cliché procedures debugged.

## Spy network

ACORN has won the Queen's Award for Industrial Espionage. This follows the demonstration of breaking all A&F's protection systems and having copies of their games on Econet within minutes of the originals arriving.

## JARGON JUNGLE

N FINCH of Chingford thought we might like to see this Buzzword Generator (right), which he came across on a computer course. 'It is used to demonstrate how jargon can look impressive but not actually mean anything,' he says. This piece, which earns Mr Finch a fiver, took minutes to compose:

'The integrated management capability leads the way for a systematic and responsive supervisory contingency with a view to increasing the inter-active transitional software design. This in turn will have a parallel in the compatibility of third-generation real-time programming.'

BUZZWORD GENERATOR

	1	2	3
1	integrated	management	options
2	systematic	organisational	mobility
3	total	monitored	flexibility
4	parallel	reciprocal	capability
5	balanced	policy	contingency
6	compatible	third-generation	projection
7	synchronised	incremental	hardware
8	optional	transitional	time-phase
9	responsive	logic	concept
10	functional	digital	programming
11	favourable	supervisory	design
12	authentic	real-time	software
13	inter-active	marginal	profitability
14	situational	appointed	facilities

Use a word from each column to make a useless but interesting 'add-to-wor...'

**SPECIAL OFFER!**  
Order both  
directly from  
us and deduct  
£1 from each.

## TWO SENSATIONAL NEW RELEASES FROM SUPERIOR SOFTWARE

**BBC  
MICRO**



### STAR STRIKER (32K)

£7.95

A multi-stage arcade-style game in which you take control of a 3-stage rocket equipped with 4 side lasers and a central laser cannon. Not only must you defend the rocket against the 6 types of circling alien, and avoid the asteroids and fireballs, but you must also attempt to dock the separate stages of the rocket together. Stunning graphics, sound effects, introductory tunes, hi-score and rankings. Another excellent program from Superior Software. (KEYBOARD or JOYSTICKS)

**OUR PROGRAMS ARE NOW  
AVAILABLE FROM OVER 1000 OUTLETS THROUGHOUT THE UK AND OVERSEAS.  
SEE YOUR LOCAL DEALER!**

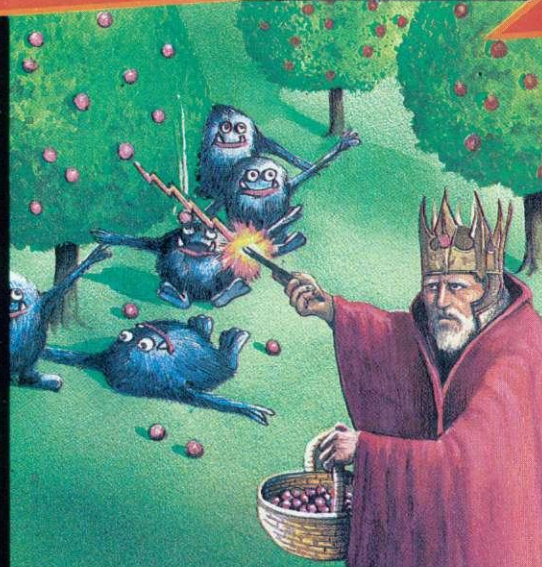

### MR. WIZ (32K)

£7.95

From the author of Percy Penguin, Mr. Wiz is a fast-action multi-scene game. Guide Mr. Wiz around the garden to eat the cherries whilst avoiding the evil gremlins. The gremlins can be killed by dropping apples on them or by throwing the crystal ball. Extra points can be gained by eating the magic mushroom, but beware... this is the home of the gremlins and makes them permanently furious! Sound effects and tunes, hi-score, rankings. Superb arcade-style action. (KEYBOARDS or JOYSTICKS).

**WE PAY UP TO 20% ROYALTIES FOR HIGH QUALITY BBC MICRO AND ELECTRON PROGRAMS**



### SUPERIOR SOFTWARE LTD.

Dept. AU7, Regent House,  
Skinner Lane, Leeds 7  
Tel: 0532 459453

#### OUR GUARANTEE

- (1) All our software is available before we advertise.
- (2) All our software is despatched within 48 hours by first-class post.
- (3) In the unlikely event that any of our software fails to load, return your cassette to us and we will immediately send a replacement.

PROGRAM POWER MICRO POWER

AN EXCITING B.B.C. MICRO PROGRAM FROM BRITAIN'S LEADING SOFTWARE HOUSE!

# JET-POWER

PROGRAM POWER MICRO POWER PROGRAM POWER MICRO POWER PROGRAM POWER MICRO POWER

PROGRAM POWER MICRO POWER PROGRAM POWER MICRO POWER PROGRAM POWER MICRO POWER



Imprisoned by the evil warlord Nogrob the Terrible, Jack the intergalactic hitchhiker must collect fuel pods from the other side of the garage to refill the waiting starships. With a fast diminishing oxygen supply, an erratic Turbopak, and a band of nasty Space Googjies to contend with, Jack certainly has problems!

Only **£7.95** (inc.VAT)

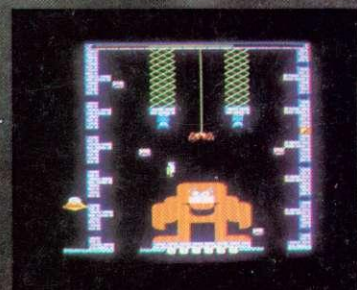
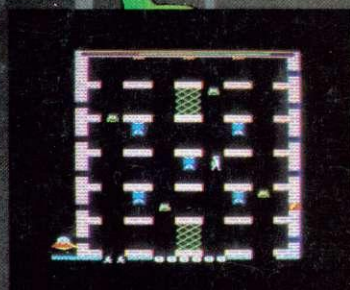
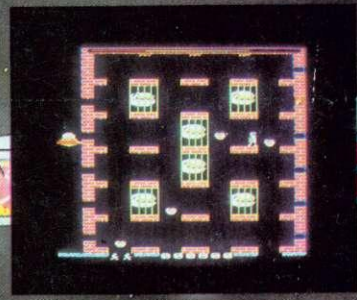

AVAILABLE FROM ALL GOOD RETAILERS INCLUDING SELECTED WRITTEN ANY PROGRAMS? WE PAY 20% ROYALTIES!

BRANCHES OF BOOTS, JOHN MENZIES AND WH SMITH.

The following top titles are available for both the BBC Micro and Electron:- Killer Gorilla £7.95/ Bandits at 3 o'Clock £6.95/Moonraider £7.95/Croaker £7.95/ Felix in the Factory £7.95/Felix and the Fruit Monsters £7.95/ Chess £7.95/Draw £9.95/Escapes from Moonbase Alpha £7.95/ Cybertron Mission £7.95/Swoop £7.95/Intergalactic Trader £8.95/ Positron £6.95/Adventure £7.95

SHOWROOM: NORTHWOOD HOUSE, NORTH STREET, LEEDS LS7 2AA Tel: (0532) 458800

MAIL ORDER: MICRO POWER LTD. 8/8a REGENT STREET, LEEDS LS7 4PE. Tel: (0532) 683186/696343

P & P: 55p per order

SPECIAL OFFER: Deduct £1 per cassette when ordering two or more

PROGRAM POWER MICRO POWER